

**DL1720E/DL1740E/DL1740EL**  
**Digital Oscilloscope**

**U S E R ' S M A N U A L**

---

# Product Registration

Thank you for purchasing YOKOGAWA products.

YOKOGAWA provides registered users with a variety of information and services.

Please allow us to serve you best by completing the product registration form accessible from our homepage.

<http://www.yokogawa.com/tm/>

---

## Foreword

Thank you for purchasing the DL1720E, DL1740E, or DL1740EL Digital Oscilloscope. This user's manual contains useful information about the functions and operating procedures of the DL1720E/DL1740E/DL1740EL, and lists the handling precautions. To ensure proper use of the instrument, please read this manual thoroughly before beginning operation. Keep this manual in a safe place for quick reference in the event a question arises. The following manuals are provided for the DL1720E/DL1740E/DL1740EL.

Manual Title	Manual No.	Description
DL1720E/DL1740E/DL1740EL User's Manual	IM701730-01E	This manual. Explains all functions and procedures of the DL1720E/DL1740E/DL1740EL excluding the communication functions.
DL1720E/DL1740E/DL1740EL Operation Guide	IM701730-02E	Provides a brief explanation of the functions and basic operating procedures of the DL1720E/DL1740E/DL1740EL.
DL1720E/DL1740E/DL1740EL Communication Interface User's Manual (CD-ROM)	IM701730-17E	Describes the communication functions of the communication interface.
DL1720E/DL1740E/DL1740EL Serial Bus Signal Analysis Function User's Manual	IM701730-51E	Explains the operating procedures of the optional serial bus signal analysis function.

## Notes

- The contents of this manual are subject to change without prior notice as a result of continuing improvements to the instrument's performance and functions. The figures given in this manual may differ from those that actually appear on your screen.
- Every effort has been made in the preparation of this manual to ensure the accuracy of its contents. However, should you have any questions or find any errors, please contact your nearest YOKOGAWA dealer.
- Copying or reproducing all or any part of the contents of this manual without the permission of Yokogawa Electric Corporation is strictly prohibited.
- The TCP/IP software of this product and the document concerning the TCP/IP software have been developed/created by YOKOGAWA based on the BSD Networking Software, Release 1 that has been licensed from California University.

## Trademarks

- Microsoft, Internet Explorer, MS-DOS, Windows, and Windows NT are either registered trademarks or trademarks of Microsoft Corporation in the United States and/or other countries.
- Adobe, Acrobat, and PostScript are trademarks of Adobe Systems Incorporated.
- UNIX is either a registered trademark or trademark of The Open Group in the United States and/or other countries.
- For purposes of this manual, the TM and ® symbols do not accompany their respective trademark names or registered trademark names.
- Other company and product names are trademarks or registered trademarks of their respective companies.

## Revisions

1st Edition: July 2004

# Checking the Contents of the Package

Unpack the box and check the contents before operating the instrument. If some of the contents are not correct, or if any items are missing or damaged, contact the dealer from which you purchased them.

## DL1720E/DL1740E/DL1740EL Main Unit

Check that the model name and suffix code given on the name plate on the rear panel of the instrument matches the ones you ordered. Also note the instrument number (NO.), and be prepared to give this number to your Yokogawa representative when contacting them for repairs and other issues.

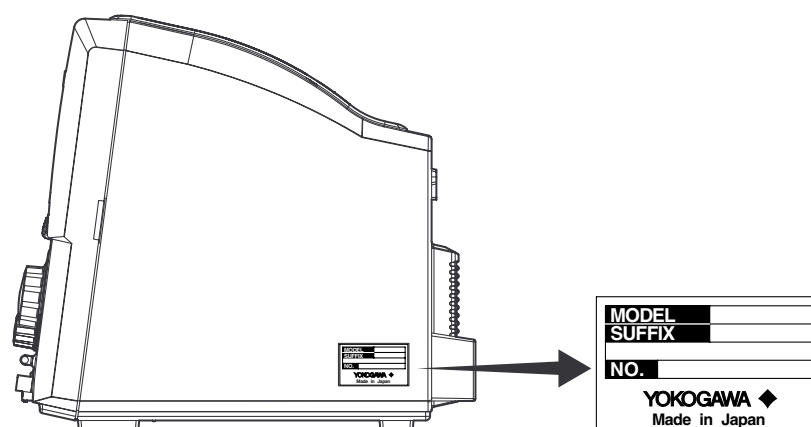

Model	Suffix	Specifications
701715 (DL1720E)		2-channel, 1 MW memory model
701730 (DL1740E)		4-channel, 2 MW memory model
701740 (DL1740EL)		4-channel, 8 MW memory model
Power cord	-D	UL/CSA Standard power cord (Part No.: A1006WD) [Maximum rated voltage: 125 V; Maximum rated current: 7 A]
	-F	VDE Standard Power Cord (Part No.: A1009WD) [Maximum rated voltage: 250 V; Maximum rated current: 10 A]
	-Q	BS Standard Power Cord (Part No.: A1054WD) [Maximum rated voltage: 250 V; Maximum rated current: 10 A]
	-R	AS Standard Power Cord (Part No.: A1024WD) [Maximum rated voltage: 250 V; Maximum rated current: 10 A]
	-H	GB Standard Power Cord (complies with the CCC)(Part No.: A1064WD) [Maximum rated voltage: 250 V, Maximum rated current: 10 A]
Built-in media drive	-J1	Floppy disk drive <sup>1</sup>
	-J3	PC card interface <sup>1</sup>
Option specifications (Optional)	/B5	Built-in printer <sup>2</sup>
	/C10	Ethernet interface
	/P2	Probe power, 2 outputs (for the DL1720E)
	/P4	Probe power, 4 outputs (for the DL1740E/DL1740EL)
	/F5	I <sup>2</sup> C + SPI Bus Signal Analysis Function

1. Select floppy disk drive or PC card interface for the built-in media drive.
2. One roll paper (B9850NX) is included.







### NO. (Instrument Number)

When contacting the dealer from which you purchased the instrument, please give them the instrument number.

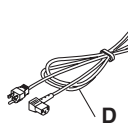
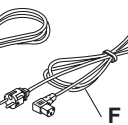
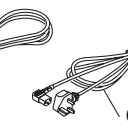
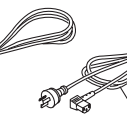
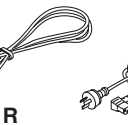
**Accessories**

The standard accessories below are supplied with the instrument. Check that no accessories are missing or damaged.

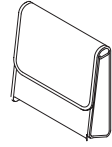
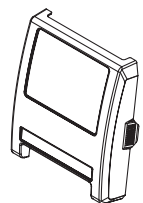
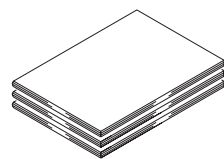



**Power Cord (one of the following power cords is supplied according to the instrument's suffix codes)**

<p><b>UL/CSA Standard A1006WD</b></p>  <p>D</p>	<p><b>VDE Standard A1009WD</b></p>  <p>F</p>	<p><b>BS Standard A1054WD</b></p>  <p>Q</p>	<p><b>AS Standard A1024WD</b></p>  <p>R</p>	<p><b>GB Standard A1064WD</b></p>  <p>H</p>	<p><b>400 MHz passive probe<sup>1</sup> 700988</b></p> 
<p><b>Printer roll paper<sup>2</sup> B9850NX</b></p> 	<p><b>Power fuse A1352EF</b></p> 	<p><b>Rubber feet 1 sheet (4 pcs.) B9989EX</b></p> 	<p><b>Probe case B9918EZ</b></p> 	<p><b>Front panel protection cover (transparent) B9989FA</b></p> 	
<p><b>User's Manual (this document) Operation Guide Serial Bus Signal Analysis Function User's Manual<sup>3</sup></b></p> <p>1 1 1</p> 	<p><b>Communication Interface User's Manual B8052YZ</b></p> <p>1</p> 				

1. The DL1720E comes with two, and the DL1740E/DL1740EL comes with four.
2. Provided only on models with the built-in printer.
3. Provided only on models with serial bus signal analysis function (/F5).

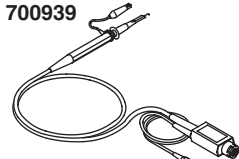
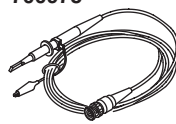
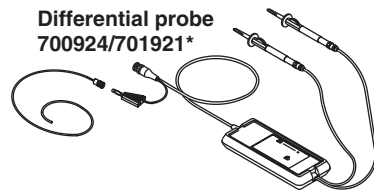
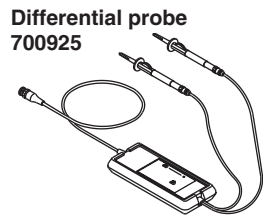
**Optional Accessories (Sold Separately)**

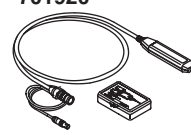
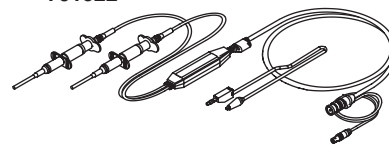
The optional accessories below are available for purchase separately. Check that no accessories are missing or damaged. For inquiries regarding accessories, please contact the dealer from which you purchased the instrument.

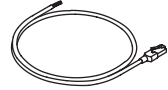
<p><b>FET probe 700939</b></p> 	<p><b>100:1 probe 700978</b></p> 	<p><b>Differential probe 700924/701921*</b></p> 	<p><b>Differential probe 700925</b></p> 
<p><b>Probe power cable (for 700924 and 700925) B9852MJ</b></p> 	<p><b>Differential probe 701920</b></p> 	<p><b>Differential probe 701922</b></p> 	
<p><b>Current probe 700937/701932</b></p> 	<p><b>Current probe 701930/701931</b></p> 	<p><b>GO/NO-GO cable 366973</b></p> 	<p>* The 701921 comes with a probe power cable (model B9852MJ).</p>

## Checking the Contents of the Package

---

### Spare Parts (Sold Separately)

The spare parts below are available for purchase separately. Check that no accessories are missing or damaged.

For inquiries regarding spare parts, please contact the dealer from which you purchased the instrument.

<b>Name</b>	<b>Part No.</b>	<b>Lot Qty.</b>	<b>Notes</b>
Roll paper for printer	B9850NX	5	Thermalsensible paper, total length of 30 m
400 MHz passive probe	700988	1	Input resistance of 10 M $\Omega$ and overall length of 1.5 m
Front panel protection cover (transparent)	B9989FA	1	

---

## Safety Precautions

This is an IEC safety class I instrument (with protective grounding).

The following general safety precautions must be taken during all phases of operation, service, and repair of this instrument. If this instrument is used in a manner not specified in this manual, the protective features provided by the instrument may be impaired. Also, Yokogawa Electric Corporation assumes no liability for the customer's failure to comply with these requirements.

### The following symbols are used on this instrument.



*Danger. Refer to the user's manual.* This symbol appears on dangerous locations on the instrument which require special instructions for proper handling or use. The same symbol appears in the corresponding place in the manual to identify those instructions.



Functional ground terminal (not to be used as a protective ground terminal).



Alternating current.



Direct current



ON (power)



OFF (power)



ON (power)



OFF (power)

**Make sure to comply with the precautions below. Not complying might result in injury or death.**

---

**WARNING**

- **Use the Correct Power Supply**  
Before connecting the power cord, ensure that the source voltage matches the rated supply voltage of the instrument and that it is within the maximum rated voltage of the provided power cord.
  - **Use the Correct Power Cord and Plug**  
To prevent the possibility of electric shock or fire, be sure to use the power cord supplied by YOKOGAWA. The main power plug must be plugged into an outlet with a protective earth terminal. Do not disable this protection by using an extension cord without protective earth grounding.
  - **Connect the Protective Grounding Terminal**  
Make sure to connect the protective earth to prevent electric shock before turning ON the power. The power cord that comes with the instrument is a three-prong type power cord. Connect the power cord to a properly grounded three-prong outlet.
  - **Do Not Impair the Protective Grounding**  
Never cut off the internal or external protective earth wire or disconnect the wiring of the protective earth terminal. Doing so poses a potential shock hazard.
  - **Do Not Operate with Defective Protective Grounding or Fuse**  
Do not operate the instrument if the protective earth or fuse might be defective. Make sure to check them before operation.
  - **Fuse**  
To prevent a fire, make sure to use fuses with the specified standard (voltage, current, type). Before replacing the fuses, turn off the power and disconnect the power source. Do not use a different fuse or short-circuit the fuse holder.
  - **Do Not Operate in an Explosive Atmosphere**  
Do not operate the instrument in the presence of flammable liquids or vapors. Operation in such environments constitutes a safety hazard.
  - **Do Not Remove Covers**  
The covers should be removed by YOKOGAWA's qualified personnel only. Opening the cover is dangerous, because some areas inside the instrument have high voltages.
  - **Ground the Instrument before Making External Connections**  
Securely connect the protective grounding before connecting to the item under measurement or an external control unit. If you are going to touch the circuit, make sure to turn OFF the circuit and check that no voltage is present.  
To prevent the possibility of electric shock or an accident, connect the ground of the probe and input connector to the ground of the item being measured.
-



---

# Conventions Used in This Manual

## Safety Markings

The following markings are used in this manual.



*Improper handling or use can lead to injury to the user or damage to the instrument.* This symbol appears on the instrument to indicate that the user must refer to the user's manual for special instructions. The same symbol appears in the corresponding place in the user's manual to identify those instructions. In the manual, the symbol is used in conjunction with the word "WARNING" or "CAUTION."

---

### **WARNING**

Describes precautions that should be observed to prevent serious injury or death to the user.

---

### **Caution**

Describes precautions that should be observed to prevent minor or moderate injury, or damage to the instrument.

### **Note**

Provides important information for the proper operation of the instrument.

## Notations Used on Pages Describing Operating Procedure

On pages that describe the operating procedures in Chapter 3 through 16, the following notations are used to distinguish the procedures from their explanations.

### **Procedure**

Carry out steps in the order shown. The operating procedures are given with the assumption that you are not familiar with the operation. Thus, it may not be necessary to carry out all the steps when changing settings.

### **Explanation**

Describes settings and restrictions relating to the operation. A detailed description of the function is not provided. For a detailed description of the function, refer to Chapter 2.

## Notations Used in the Procedure

---

### **Panel Keys and Soft keys**

Bold characters used in the procedural explanations indicate characters that are marked on the panel keys or the characters of the soft keys displayed on the screen menu.

---

### **SHIFT+Panel Key**

SHIFT+key means you will press the SHIFT key (causing the green indicator to the left of the SHIFT key to illuminate), and then press a panel key. The setup menu marked in purple above or below the panel key that you pressed appears on the screen.

---

### **Jog Shuttle & SELECT**

Jog shuttle & SELECT indicates selecting or setting parameters and entering values using the jog shuttle, the SELECT key, and other keys. For details on the procedure, see section 4.1 or 4.2.

---

### **Unit**

k Denotes "1000." Example: 100 kS/s

K Denotes "1024." Example: 459 KB (file data size)

---

# Flow of Operation

The figure below is provided to familiarize the first-time user with the general flow of the instrument operation. For a description of each item, see the relevant section or chapter.

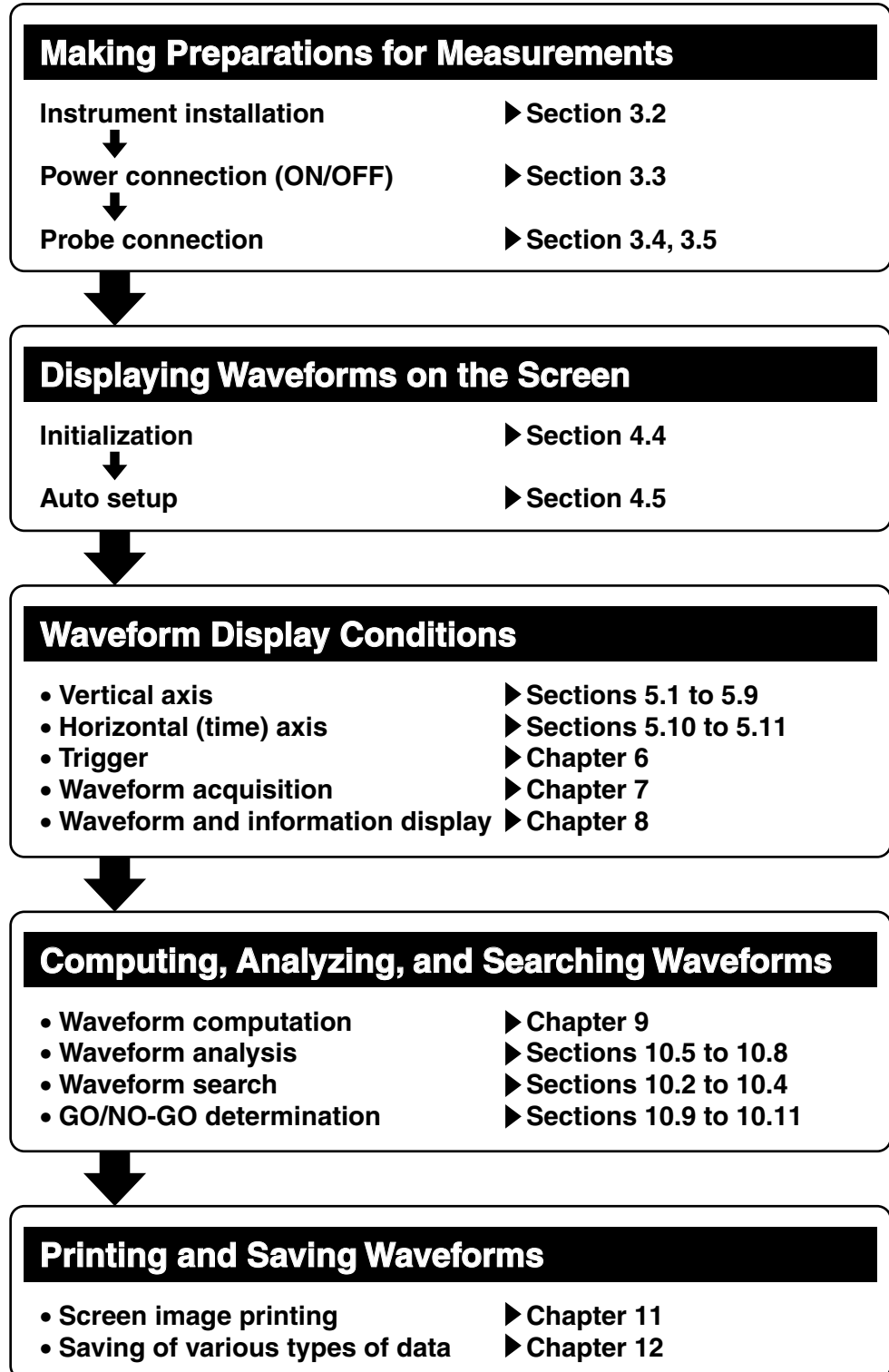

# Contents

Checking the Contents of the Package .....	ii
Safety Precautions .....	v
Conventions Used in This Manual .....	vii
Flow of Operation .....	viii
<b>Chapter 1 Names and Functions of Parts</b>	
1.1 Front Panel, Rear Panel, and Top Panel .....	1-1
1.2 Panel Keys and Knobs .....	1-4
1.3 Display Screens .....	1-8
<b>Chapter 2 Explanation of Functions</b>	
2.1 System Configuration and Block Diagram .....	2-1
2.2 Vertical and Horizontal Axis .....	2-3
Vertical Sensitivity (V/div), Vertical Position of the Waveform, Input Coupling, Probe Attenuation/Current-to-Voltage Conversion Ratio, Offset Voltage, Bandwidth Limit, Linear Scaling, Horizontal Axis (Time Axis)	
2.3 Triggers .....	2-8
Trigger Source, Trigger Slope, and Trigger Level, Trigger Type, Trigger Mode, Trigger Position, Trigger Delay, Trigger Coupling, HF Rejection, Trigger Gate, Trigger Hysteresis, Trigger Hold Off, Action-on-Trigger	
2.4 Waveform Acquisition and Display Conditions .....	2-14
Record Length, Interleave Mode, Sampling Mode, Acquisition Mode, Sequential Store, History Memory, Display Format, Display Interpolation, Accumulated Display, Zooming the Waveform, X-Y Waveform Display, Snapshot, Clear Trace, Other Waveform Display Settings .....	2-20
2.5 Waveform Computation .....	2-21
Addition, Subtraction, and Multiplication, Binary Computation, Inversion, Differentiation (Diff) and Integration (Integ), Phase Shift, Scaling the Computed Waveform, Power Spectrum Display	
2.6 Analyzing, and Searching Waveforms .....	2-23
Displaying History Waveforms, History Search, Search and Zoom, Cursor Measurements, Automated Measurement of Waveform Parameters, GO/NO-GO Determination	
2.7 Communication .....	2-30
Communication Using Commands (GP-IB, USB, or Ethernet), Saving and Loading Data from a Network Drive (FTP Client), Printing on a Network Printer (LPR Client), Transmitting E-Mails (SMTP Client), Accessing the instrument from a PC or Workstation (FTP Server), Web Server, Using the Instrument as a Network Drive	
2.8 Other Useful Functions .....	2-32
Entering Values and Text Using the USB Keyboard, Operating the Instrument Using a USB Mouse, Initialization, Auto Setup, Preset, Printing Screen Images, Saving and Loading Data from the Storage Medium, Operating the instrument Using a Free Software Program	
<b>Chapter 3 Making Preparations for Measurements</b>	
3.1 Handling Precautions .....	3-1
△ 3.2 Installing the Instrument .....	3-3
△ 3.3 Connecting the Power Supply and Turning the Power Switch ON and OFF .....	3-5
△ 3.4 Connecting the Probe .....	3-8
△ 3.5 Compensating the Probe (Phase Correction) .....	3-11
3.6 Setting the Date and Time .....	3-13

**Chapter 4 Common Operations**

4.1 Operations and Functions of Keys and the Jog Shuttle ..... 4-1

4.2 Entering Values and Strings ..... 4-3

4.3 Operating the instrument Using a USB Keyboard or a USB Mouse ..... 4-6

4.4 Initializing Settings ..... 4-13

4.5 Executing Auto Setup ..... 4-15

4.6 Performing Calibration ..... 4-18

4.7 Correcting the Delay Time of the Input Signals ..... 4-20

4.8 Using the Help Function ..... 4-22

**Chapter 5 Vertical and Horizontal Axes**

5.1 Turning Channels ON and OFF ..... 5-1

5.2 Setting V/div ..... 5-2

5.3 Setting the Vertical Position of the Waveform ..... 5-4

△ 5.4 Setting the Input Coupling ..... 5-6

5.5 Selecting the Probe Attenuation/Current-to-Voltage Conversion Ratio ..... 5-8

5.6 Setting the Offset Voltage ..... 5-9

5.7 Using the Preset Function ..... 5-11

5.8 Setting the Bandwidth Limit ..... 5-14

5.9 Using the Linear Scaling Function ..... 5-15

△ 5.10 Selecting the Time Base ..... 5-17

5.11 Setting T/div ..... 5-19

**Chapter 6 Triggers**

6.1 Selecting the Trigger Mode ..... 6-1

6.2 Setting the Trigger Position ..... 6-3

6.3 Setting the Trigger Delay ..... 6-5

6.4 Setting the Hold Off Time ..... 6-6

6.5 Setting the Edge Trigger (SIMPLE) ..... 6-8

6.6 Setting the External Trigger (SIMPLE) ..... 6-11

6.7 Activating Triggers on the Commercial Power Supply (SIMPLE) ..... 6-13

6.8 Setting the A->B(N) Trigger (ENHANCED) ..... 6-14

6.9 Setting the A Delay B Trigger (ENHANCED) ..... 6-17

6.10 Setting the Pattern Trigger (ENHANCED) ..... 6-20

6.11 Activating a Width (Pulse<T, Pulse>T, T1<PLS<T2, and  
Time Out) Trigger (ENHANCED) ..... 6-24

6.12 Setting the OR Trigger (ENHANCED) ..... 6-28

6.13 Setting a Window Trigger (ENHANCED) ..... 6-31

6.14 Setting the TV Trigger (ENHANCED) ..... 6-34

6.15 Setting the Action-on-Trigger ..... 6-38

△ 6.16 Setting the Trigger Gate ..... 6-40

**Chapter 7 Waveform Acquisition**

7.1 Starting/Stopping Waveform Acquisition ..... 7-1

7.2 Setting the Record Length ..... 7-2

7.3 Using Interleave Mode ..... 7-3

7.4 Turning Repetitive Sampling Mode ON and OFF ..... 7-4

7.5 Setting the Acquisition Mode ..... 7-5

7.6 Performing Sequential Store (SINGLE(N) Mode) ..... 7-8

<b>Chapter 8</b>	<b>Waveform Display and Information Display</b>		<b>1</b>
8.1	Changing the Display Format .....	8-1	<b>2</b>
8.2	Setting the Display Interpolation Method .....	8-3	<b>3</b>
8.3	Accumulating Waveforms .....	8-5	<b>4</b>
8.4	Zooming the Waveform .....	8-7	<b>5</b>
8.5	Displaying the X-Y Waveform .....	8-10	<b>6</b>
8.6	Taking Snapshots and Clearing Traces .....	8-13	<b>7</b>
8.7	Changing the Graticule (Scale) .....	8-14	<b>8</b>
8.8	Turning the Scale Display ON and OFF .....	8-15	<b>9</b>
8.9	Setting Waveform Labels .....	8-16	<b>10</b>
8.10	Turning the Translucent Display ON and OFF .....	8-18	<b>11</b>
<b>Chapter 9</b>	<b>Waveform Computation</b>		<b>12</b>
9.1	Displaying and Labeling Computed Waveforms .....	9-1	<b>13</b>
9.2	Adding, Subtracting, and Multiplying Waveforms .....	9-3	<b>14</b>
9.3	Performing Binary Computation .....	9-6	<b>15</b>
9.4	Inverting Waveforms .....	9-8	<b>16</b>
9.5	Differentiating and Integrating Waveforms .....	9-10	<b>App</b>
9.6	Performing Power Spectrum Computation (FFT) .....	9-12	<b>17</b>
9.7	Smoothing Waveforms .....	9-14	<b>18</b>
9.8	Shifting the Phase .....	9-16	<b>19</b>
<b>Chapter 10</b>	<b>Analyzing and Searching Waveforms</b>		<b>20</b>
10.1	Displaying History Waveforms .....	10-1	<b>21</b>
10.2	Searching the History Waveforms Using Zones (History Search) .....	10-5	<b>22</b>
10.3	Searching the History Waveforms Using Automatic Measurement of Parameters (History Search) .....	10-9	<b>23</b>
10.4	Searching Waveforms Using the Search and Zoom Function .....	10-14	<b>24</b>
10.5	Cursor Measurements .....	10-31	<b>25</b>
10.6	Automated Measurement of Waveform Parameters .....	10-39	<b>26</b>
10.7	Statistical Processing of the Automated Measurement Values of Waveform Parameters .....	10-46	<b>27</b>
10.8	Performing Automated Measurements of Waveform Parameters on Dual Areas .....	10-53	<b>28</b>
10.9	Performing GO/NO-GO Determination Using Zones .....	10-58	<b>29</b>
10.10	Performing GO/NO-GO Determination Using Automated Measurement of Waveform Parameters .....	10-64	<b>30</b>
10.11	Using the GO/NO-GO Determination Signal Output Function .....	10-68	<b>31</b>
<b>Chapter 11</b>	<b>Printing Screen Images</b>		<b>32</b>
11.1	Installing the Roll Paper into the Built-in Printer (Optional) .....	11-1	<b>33</b>
11.2	Printing Using the Built-in Printer (Optional) .....	11-3	<b>34</b>
11.3	Printing Using a USB Printer .....	11-6	<b>35</b>
11.4	Printing Using a Network Printer (Optional) .....	11-10	<b>36</b>
<b>Chapter 12</b>	<b>Saving and Loading Data</b>		<b>37</b>
12.1	Storing and Recalling Setup Data .....	12-1	<b>38</b>
12.2	Floppy Disks and PC Cards .....	12-3	<b>39</b>
12.3	Connecting USB Storage (MO Disk Drive, Hard Disk, Flash Memory) to the USB PERIPHERAL Interface .....	12-6	<b>40</b>
12.4	Formatting the Storage Medium .....	12-8	<b>41</b>
12.5	Saving/Loading the Waveform Data .....	12-12	<b>42</b>
12.6	Saving/Loading Settings .....	12-20	<b>43</b>

12.7	Saving/Loading the Snapshot Waveforms .....	12-26
12.8	Saving Automated Measurement Values of Waveform Parameters .....	12-30
12.9	Saving Screen Image Data .....	12-33
12.10	Thumbnails of the Saved Screen Image Data can be Displayed .....	12-37
12.11	Changing the File Attributes and Deleting Files .....	12-42
12.12	Copying Files .....	12-46
12.13	Changing the Directory or File Name of the Storage Medium and Creating Directories .....	12-50

## Chapter 13 Ethernet Communications (Optional)

13.1	Connecting the Instrument to the Network .....	13-1
13.2	Setting Up the TCP/IP .....	13-3
13.3	Saving and Loading Waveform Data, Setup Data, and Image Data on a Network Drive (FTP Client Function) .....	13-8
13.4	Entering Settings for Printing Screen Images on the Network Printer (LPR Client Function) .....	13-11
13.5	Sending Periodic or Action Mail (SMTP Client Function) .....	13-13
13.6	Accessing the Instrument from a PC or Workstation (FTP Server Function) .....	13-18
13.7	Using the Web Server Function .....	13-20
13.8	Setting the Time Difference from GMT (Greenwich Mean Time) .....	13-45
13.9	Checking the Presence of the Ethernet Interface (Optional) and the MAC Address .	13-47
13.10	Setting the FTP Passive Mode and LPR/SMTP Timeout .....	13-49
13.11	Using the Instrument as a Network Drive .....	13-51

## Chapter 14 Rear Panel Auxiliary I/O Section

△	14.1	External Trigger Input, External Clock Input, and Trigger Gate Input .....	14-1
△	14.2	Trigger Output (TRIG OUT) .....	14-4
△	14.3	Video Signal Output (VIDEO OUT (VGA)) .....	14-6

## Chapter 15 Other Operations

15.1	Changing the Message and Menu Language and Turning the Click Sound ON and OFF .....	15-1
15.2	Changing the USB Keyboard Language and Checking the Connected USB Keyboard .....	15-3
15.3	Measuring the Offset Voltage and Applying the Offset Voltage to the Computed Results .....	15-5
15.4	Setting the Screen Color and Intensity .....	15-6
15.5	Turning OFF the Backlight and Setting the Brightness of the Backlight .....	15-9

## Chapter 16 Troubleshooting, Maintenance, and Inspection

16.1	Malfunction? First, Investigate. ....	16-1
16.2	Messages and Corrective Actions .....	16-2
16.3	Performing a Self-Test .....	16-7
16.4	Display an Overview of the System Conditions (Overview) .....	16-10
16.5	Replacing the Power Fuse .....	16-11
16.6	Recommended Replacement Parts .....	16-12

## Chapter 17 Specifications

17.1	Input Section .....	17-1
17.2	Trigger Section .....	17-2
17.3	Time Axis .....	17-3
17.4	Display .....	17-4

17.5	Functions .....	17-4
17.6	Built-in Printer (Optional) .....	17-7
17.7	Storage .....	17-7
17.8	USB Peripheral Interface .....	17-7
17.9	Auxiliary I/O Section .....	17-8
17.10	Computer Interface .....	17-9
17.11	General Specifications .....	17-10
17.12	Dimensional Drawings .....	17-12

**Appendix**

Appendix 1	Relationship between the Time Axis Setting, Sample Rate and Record Length .....	App-1
Appendix 2	How to Calculate the Area of a Waveform .....	App-11
Appendix 3	ASCII Header File Format .....	App-13
Appendix 4	List of Default Values .....	App-17
Appendix 5	Key Assignments of the USB Keyboard .....	App-18

**Index**

<b>1</b>
<b>2</b>
<b>3</b>
<b>4</b>
<b>5</b>
<b>6</b>
<b>7</b>
<b>8</b>
<b>9</b>
<b>10</b>
<b>11</b>
<b>12</b>
<b>13</b>
<b>14</b>
<b>15</b>
<b>16</b>
<b>17</b>
<b>App</b>
<b>Index</b>

# 1.1 Front Panel, Rear Panel, and Top Panel

## Front Panel

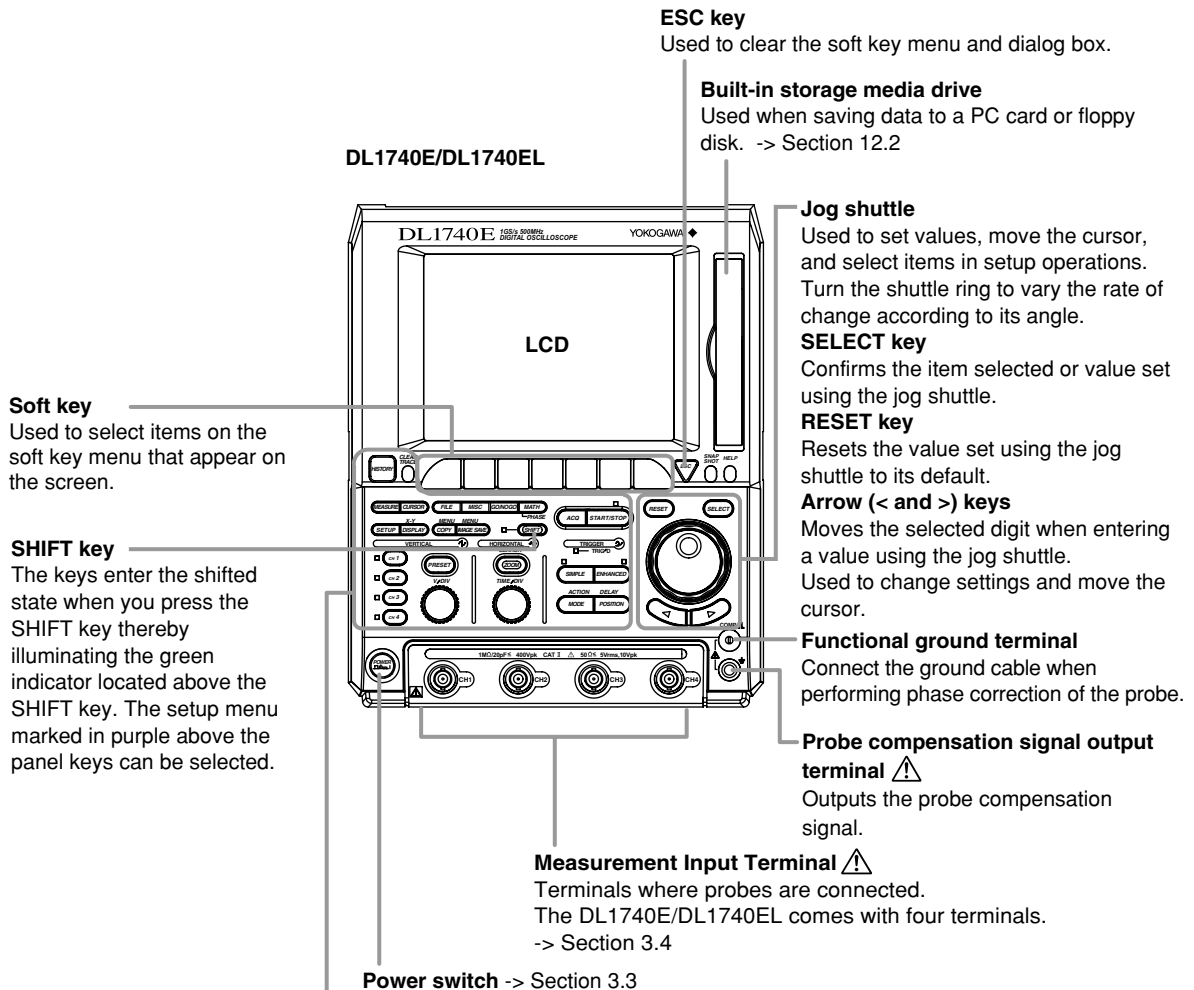

### Panel keys and knobs

Keys/Knobs that are pressed first when entering a setting or executing an operation. Display various setup menus. For execution keys, the operation of the pressed key is executed. For a description of the names and functions of the panel keys and knobs, see section 1.2.

### DL1720E

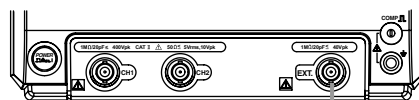



Rear Panel

DL1740E/DL1740EL

**Ethernet port (optional)**

Used when connecting to a network. -> Section 13.1

**Video signal output connector**

Used when displaying the instrument's screen image on an external display. -> Section 14.3

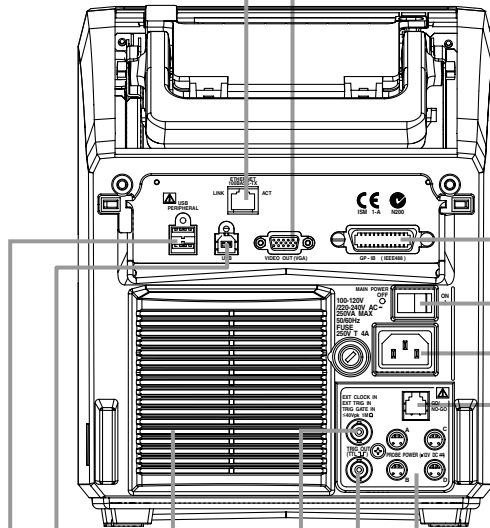

**GP-IB connector**

Used when carrying out communications via the GP-IB interface. For details on the communication function excluding the Ethernet communications, see the *Communication Interface User's Manual (IM701730-17E)*.

**Main power switch** ⚠ -> Section 3.3

**Power connector** ⚠ -> Section 3.3

**GO/NO-GO determination output terminal**  
Outputs GO/NO-GO determination results. -> Section 10.11

**Exhaust holes**  
-> Section 3.2

**Probe power supply terminal** ⚠

Used to supply power to the FET probe or current probe made by YOKOGAWA. The DL1740E/DL1740EL comes with four terminals. -> Section 3.4

**Trigger output terminal**

Used when outputting the trigger signal externally. -> Section 14.2

**External trigger/external clock/trigger gate input terminal** ⚠

Used when inputting external trigger, clock, or trigger gate signals. -> Sections 6.6, 6.16, and 14.1

**USB connector for connecting to a PC**

Used when connecting a PC with a USB interface. -> Communication Interface User's Manual (IM701730-17E).

**USB connector for connecting peripheral devices** ⚠

Used when connecting a USB printer, USB keyboard, USB mouse, or USB storage. -> Sections 4.3, 11.3, and 12.3

DL1720E

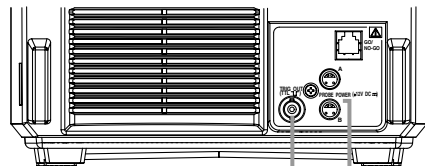

**Probe power supply terminal** ⚠

Used to supply power to the FET probe or current probe made by YOKOGAWA. The DL1720E comes with two. -> Section 3.4

**Trigger output terminal**

Used when outputting the trigger signal externally. -> Section 14.2

Top Panel

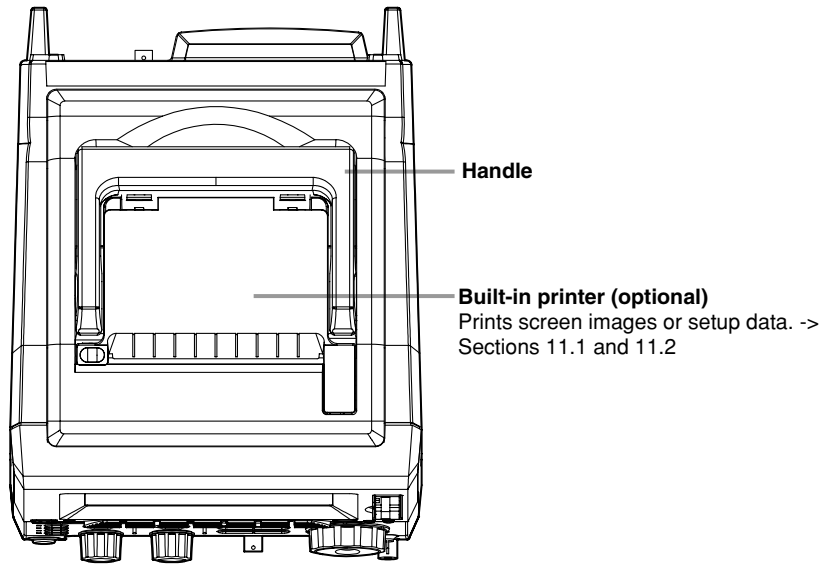

## 1.2 Panel Keys and Knobs

### Vertical Axis

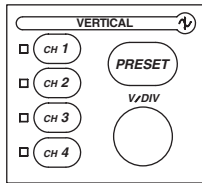

#### CH1 to CH4\* Keys (Sections 5.1 to 5.10, and 8.9)

- Each key displays a menu used to turn ON/OFF the channel's display and set the vertical position, coupling, probe attenuation/current-to-voltage conversion ratio, offset voltage, bandwidth limit, expansion or reduction of the vertical axis, linear scaling, and waveform labels.
- If you press a CH key before operating the V/DIV knob to display the menu for the channel, the channel becomes controllable using the V/DIV knob.
- The indicator to the left of each CH key illuminates when the channel is ON.
  - \* There are two channel keys (CH1 and CH2) on the DL1720E and four channel keys (CH1 to CH4) on the DL1740E/DL1740EL. The notation CH1 to CH4(2) is used in this manual to indicate that CH1 to CH2 or CH1 to CH4 can be controlled or configured on the DL1720E and the DL1740E/DL1740EL, respectively.

#### Note

The setup menu used to specify whether the offset voltage is applied to the measured and computed results is located in the menu that appears when the MISC key (see section 1-7) is pressed.

#### V/DIV Knob (Section 5.2)

- Sets the vertical sensitivity\*.
- Before turning this knob, press one of the CH1 to CH4(2) keys to show the menu for the channel and have the channel selected.
- If you change the vertical sensitivity setting when waveform acquisition is stopped, the new setting takes effect when you restart waveform acquisition.
  - \* In the attenuation/current-to-voltage conversion ratio setting of the probe, if the probe attenuation is specified, the voltage sensitivity is set. If the current-to-voltage conversion ratio is specified, the current sensitivity is set.

#### PRESET Key (Section 5.7)

- Displays a menu used to automatically set the probe attenuation/current-to-voltage conversion ratio, V/div, offset voltage, trigger level, and other parameters to the optimum values for CMOS or ECL signals (or to arbitrary values).
- Presets can also be applied to all channels at once.

### Horizontal Axis

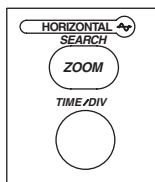

#### TIME/DIV Knob (Section 5.11)

- Sets the horizontal axis (time axis) scale.
- If you change the setting when waveform acquisition is stopped, the new setting takes effect when you restart waveform acquisition.

#### ZOOM Key (Section 8.4)

Displays a menu used to set the zoom display of waveforms.

#### SHIFT+ZOOM (SEARCH) Key (Section 10.4)

Displays a menu used to set waveform searches (Search and Zoom function).

## Triggers

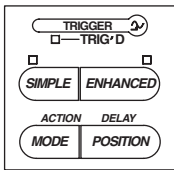

### MODE Key (Sections 6.1 and 7.6)

Displays a menu used to set the trigger mode and sequential store.

### SHIFT+MODE (ACTION) Key (Section 6.15)

Displays a menu used to set the action-on-trigger.

### SIMPLE Key (Sections 6.5 to 6.7)

- Displays a menu used to set the simple trigger (normal edge trigger).
- The simple trigger setting is activated when the indicator located above and to the left of the SIMPLE key is illuminated.

### ENHANCED Key Sections (6.8 to 6.14)

- Displays a menu used to set the enhanced trigger (activates complex triggers such as pattern triggers).
- The enhanced trigger setting is activated when the indicator located above and to the left of the ENHANCED key is illuminated.

### POSITION Key (Section 6.2)

Displays a menu used to set the trigger position.

### SHIFT+POSITION (DELAY) Key (Section 6.3)

Displays a menu used to set the trigger delay.

### TRIG'D Indicator

Illuminates when a trigger is activated.

### Note

The setup menu for the trigger gate is located in the menu that appears when the MISC key (see page 1-7) is pressed.

## Common Operations and Waveform Acquisition, Display, Computation, Analysis, and Search

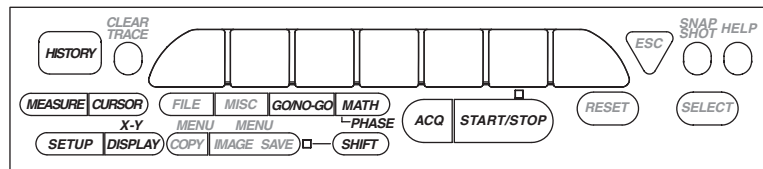

### SETUP Key (Sections 4.4, 4.5, and 12.1)

Displays the auto setup menu in which settings can be automatically configured according to the input signal, the initialize menu in which settings can be initialized to their factory defaults, and the setup data can be stored/recalled.

### DISPLAY Key (Sections 8.1 to 8.3, and 8.7, 8.8, and 8.10)

Displays a menu used to set the waveform display and information display.

### SHIFT+DISPLAY (X-Y) Key (Section 8.5)

Displays a menu used to set the X-Y display.

### MEASURE Key (Sections 10.6 to 10.8)

Displays a menu used to set the automated measurement of waveform parameters and statistical processing.

### CURSOR Key (Section 10.5)

Displays a menu used to set cursor measurements.

## 1.2 Panel Keys and Knobs

---

### **GO/NO-GO Key (Sections 10.9 and 10.10)**

Displays a menu used to set GO/NO-GO determination.

### **MATH Key (Sections 9.1 to 9.7)**

Displays a menu used to set waveform computation.

### **SHIFT+MATH (PHASE) Key (Section 9.8)**

Displays a menu used to set phase shifts.

### **HISTORY Key (Sections 10.1 to 10.3)**

Displays a menu used to display and search waveforms using the history memory function. Waveforms that have been sequentially stored can also be displayed and searched.

### **ACQ Key (Sections 5.10 and 7.2 to 7.5)**

Displays a menu used to set the record length, acquisition mode, interleave mode, sampling mode, time base, and other parameters for waveform acquisition.

### **START/STOP Key (Section 7.1)**

Starts/Stops waveform acquisition according to the trigger mode. Waveform acquisition is in progress when the indicator above the START/STOP key is illuminated.

## Printing Screen Images and Saving and Loading Data

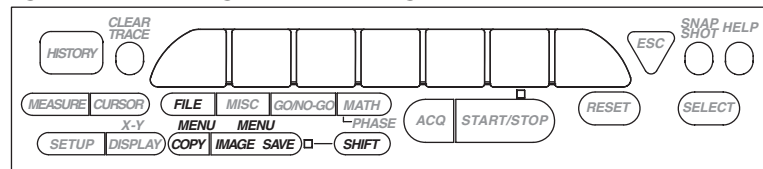

### **FILE Key (Sections 12.4 to 12.8, and 12.11 to 12.13)**

- Displays a menu used to save or load various data from the storage medium (built-in storage medium, external USB storage, or net drive).
- You can display thumbnails of the screen image data that are saved.

### **COPY Key (Chapter 11)**

Executes the printing of the screen image on a printer (built-in printer, USB printer, or network printer).

### **SHIFT+COPY (MENU) Key (Sections 11.2 to 11.4)**

Displays a menu used to print screen images on a printer.

### **IMAGE SAVE Key (Section 12.9)**

Executes the saving of the screen image data to a storage medium.

### **IMAGE SAVE (MENU) Key (Sections 12.9 and 12.10)**

- Displays a menu used to save screen image data to a storage medium.
- You can display thumbnails of the screen image data that are saved.

## Calibration, Ethernet Communications, and Other Operations

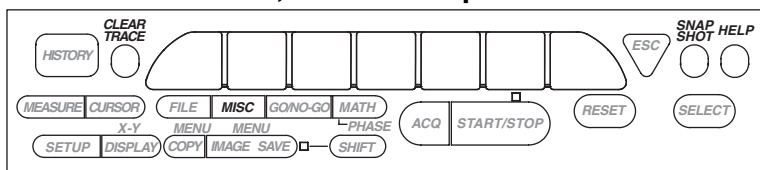

### MISC Key

- > Sections 3.6, 4.6, 4.7, 6.16, chapters 13 and 15, sections 16.3, 16.4, and the Communication Interface User's Manual (IM701730-17E)
- Displays a menu used to set the date/time, calibration, input signal delay time correction, trigger gate, Ethernet communications, menu and message language, ON/OFF of the click sound, USB keyboard language, ON/OFF of the application of the offset voltage to the measured and computed results, screen color and intensity, backlight, self test, and remote control.
- Displays the setup data and system condition (the presence/absence of options, firmware version, etc.).

### SNAP SHOT Key (Section 8.6)

Freezes the currently displayed waveform on the screen in black and white (default setting).

### CLEAR TRACE Key (Section 8.6)

Clears the snapshot waveforms and accumulated waveforms.

### HELP Key (Section 4.8)

Turns the help window that provides description about the procedure ON and OFF.

# 1.3 Display Screens

## Normal Display Screen

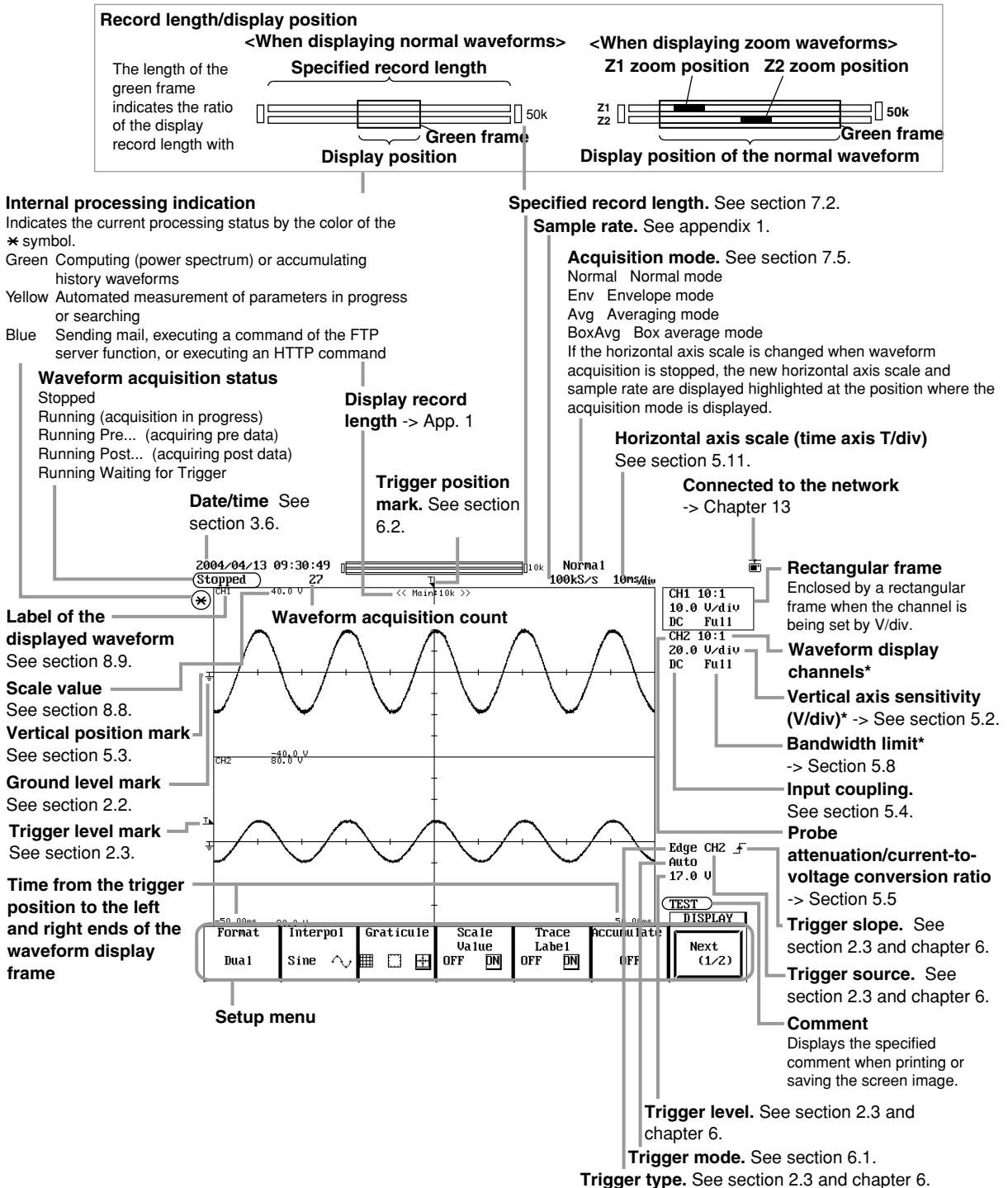

\* If the vertical axis scale is changed when waveform acquisition is stopped, the new vertical axis sensitivity is displayed highlighted at the position where the input coupling and bandwidth limit are displayed.

### Note

In some cases, the LCD on the instrument may include a few defective pixels. For details, see section 17.5.

Display Example When Displaying Zoom Waveforms

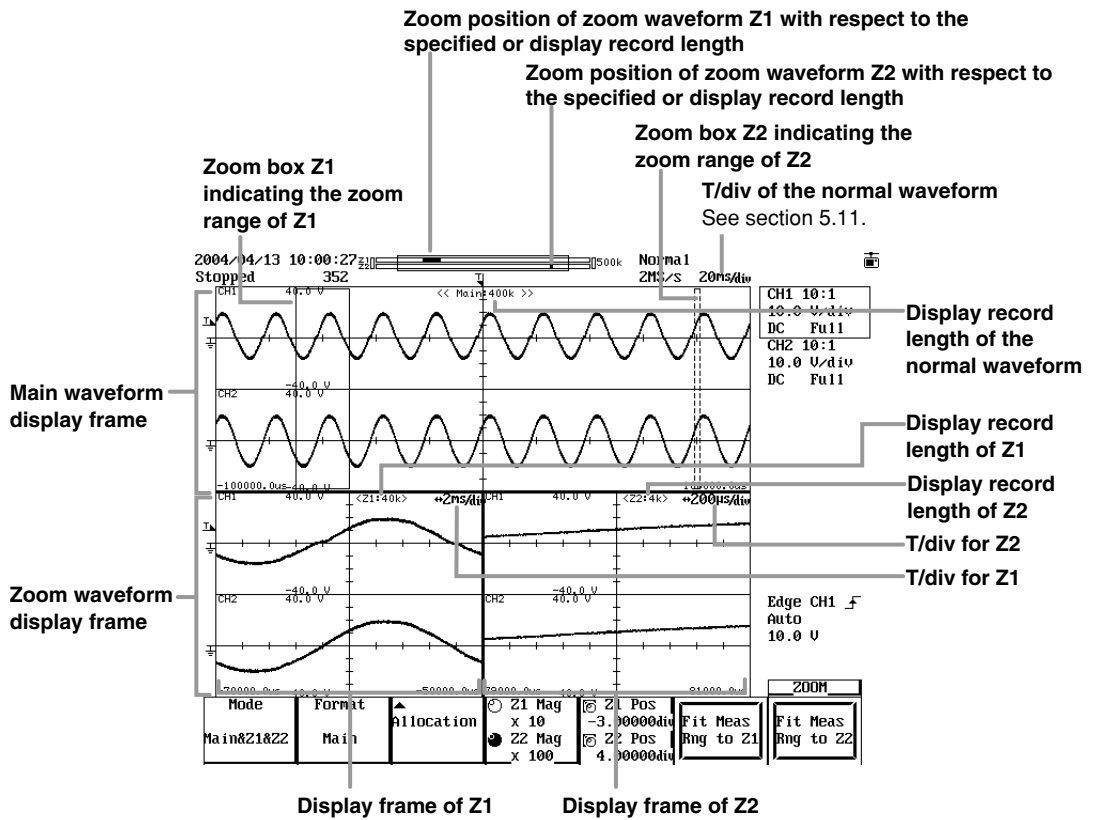

Display Example When Displaying X-Y Waveforms

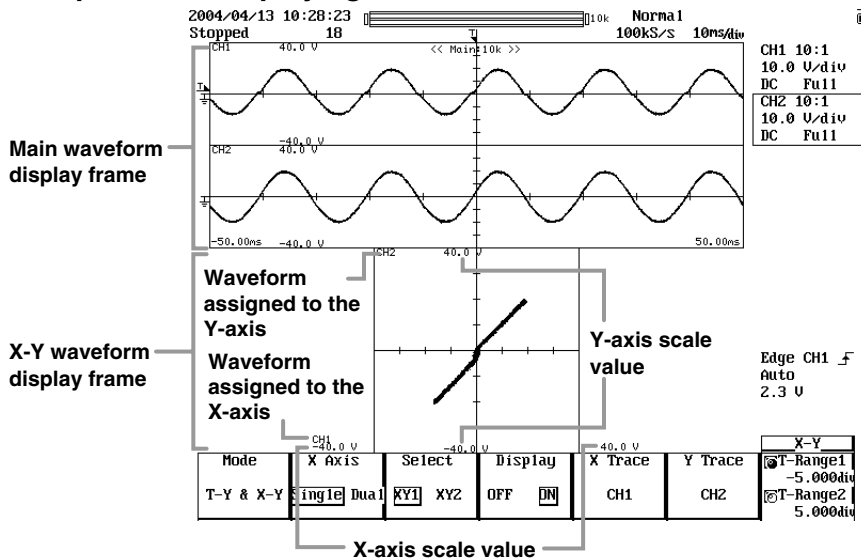



### Display Example of the Setup Information List

If you press the Setup Info soft key (displayed on the second page of the menu that appears when pressing the MISC key), a list of setup data is displayed as shown below. This screen can be printed as additional information (see section 11.2) when the waveforms displayed on the screen (screen image) are printed on the built-in printer (optional).

#### List of Setup Information

Setup data related to the vertical axis, trigger, and horizontal axis of CH1 to CH4(2) is displayed.

2004/04/06 15:55:53 10k Normal

Setup Information

VERTICAL				
	CH1	CH2	CH3	CH4
U/div	0.500 U	0.500 U	0.500 U	0.500 U
Coupling	DC1M $\Omega$	DC1M $\Omega$	DC1M $\Omega$	DC1M $\Omega$
Probe	10:1	10:1	10:1	10:1
Offset	0.000 U	0.000 U	0.000 U	0.000 U
Position	0.00div	0.00div	0.00div	0.00div
Bandwidth	Full	Full	Full	Full

TRIGGER		HORIZONTAL	
Type	Edge	T/div	5ms/div
Mode	Auto	Sample Rate	200kS/s
Position	50.0%	ACQ Mode	Normal
Delay	0.0us	Record Length	Main:10k
Hold Off	0.00us	Z1	:1k
Gate	OFF	Z2	:200
Source	CH1	Time Base	Int
		Interleave	OFF

	CH1	CH2	CH3	CH4	Ext
Level	0.300 U	0.300 U	0.000 U	0.000 U	0.000 U
Slope	f	f	f	f	f
Coupling	DC	DC	DC	DC	
HFrej	OFF	OFF	OFF	OFF	
Hjs	f	f	f	f	

CH1 10:1  
0.500 U/div  
DC Full

CH2 10:1  
0.500 U/div  
DC Full

Edge CH1 f  
Auto  
0.300 U

test

MISC

Back (2/2)

# 2.1 System Configuration and Block Diagram

## System Configuration

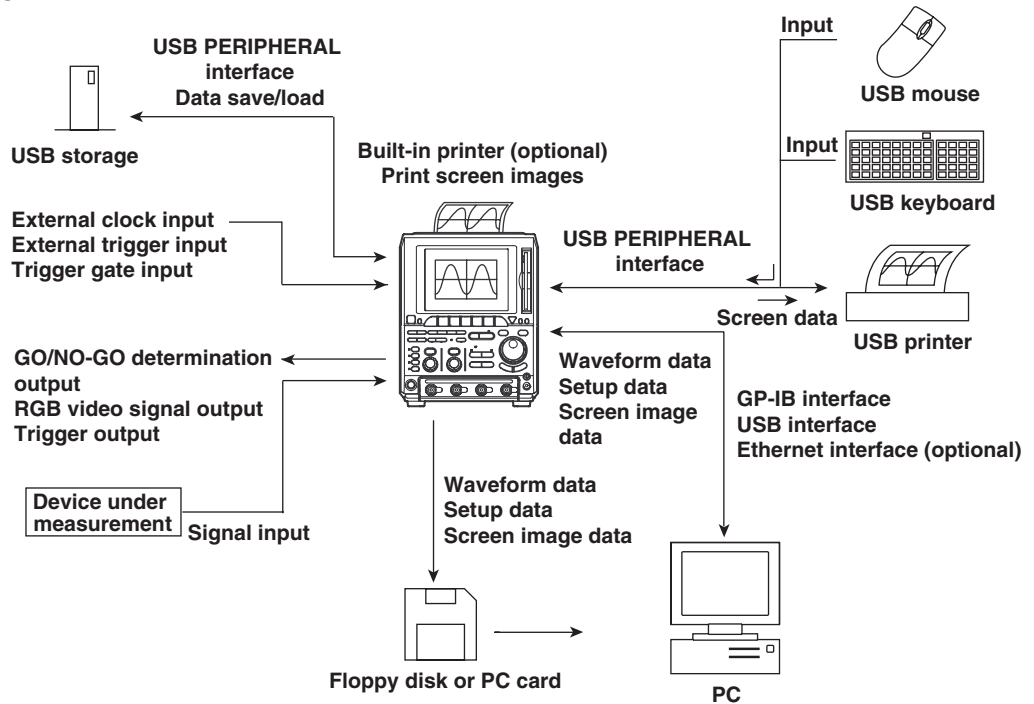

## Block diagram

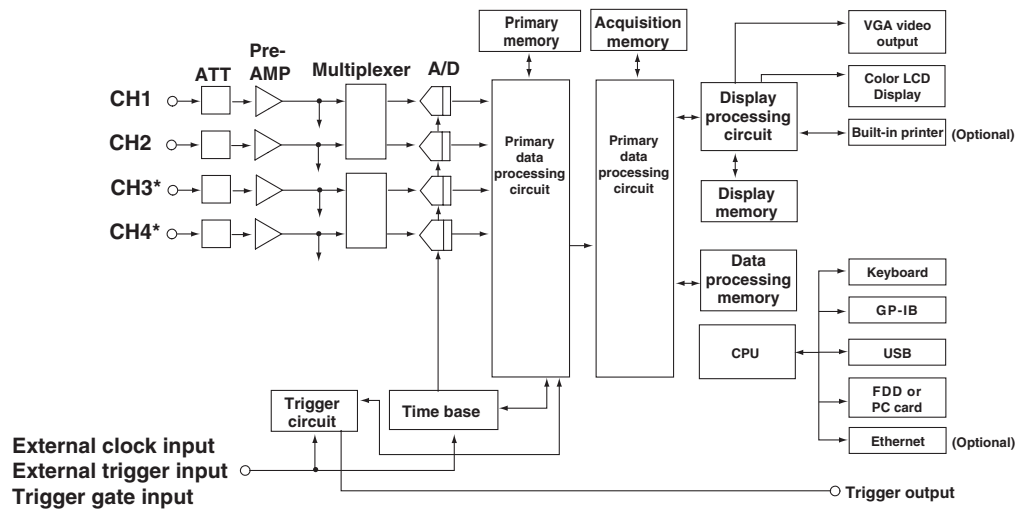

\* CH3 and CH4 not available on the DL1720E. On the DL1720E, an input terminal is provided in the CH4 position that can be used alternately for an external trigger, external clock, or trigger gate.

## 2.1 System Configuration and Block Diagram

---

### Signal Flow

The signal applied to each signal input terminal is first passed to the vertical control circuit consisting of an attenuator (ATT) and pre-amplifier. At the attenuator and pre-amplifier, the voltage and amplitude of each input signal is adjusted according to the settings such as the input coupling, probe attenuation ratio, V/div, and offset voltage. The adjusted input signal is then passed to the multiplexer, and then passed from the multiplexer to the A/D converters according to the time axis settings.

At the A/D converter, the received voltage level is converted into digital values. The digital data is written to the primary memory by the primary data processing circuit at the sample rate that matches the time axis setting.

The data written to the primary memory is processed (averaged, for example) by the secondary data processing circuit and written to the acquisition memory.

The data written to the acquisition memory is converted into waveform display data by the secondary data processing circuit, transferred to the waveform processing circuit, and stored in the display memory. The waveforms are displayed on the LCD using the data stored in the display memory.

## 2.2 Vertical and Horizontal Axis

### Vertical Sensitivity (V/div) <For the setup procedure, see section 5.2>

The vertical sensitivity setting is used to adjust the displayed amplitude of the waveform for easy viewing.

The vertical sensitivity is set by assigning a voltage to one grid square (one division) on the screen.

By switching attenuators with different attenuation and changing the amplification of the pre-amplifier, the sensitivity changes in steps (for example, vertical axis sensitivity changes in steps as in 1 V/div, 2 V/div, and 5 V/div).

In addition, by computing the digital data of the waveforms acquired at the vertical sensitivity described above, the waveforms can be displayed by setting the sensitivity to 0.4 (or 0.5) to 10 times the vertical axis setting that was used to acquire the waveforms (Variable).

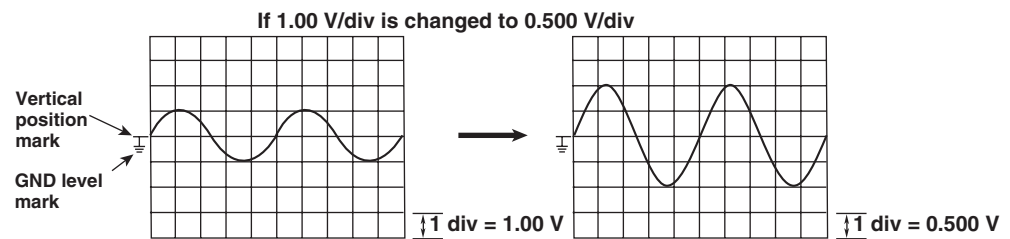

#### Note

##### Voltage Axis Sensitivity Setting and Measurement Resolution

For precise voltage measurements, set the voltage axis sensitivity so that the amplitude of the displayed waveform is maximized.

The instrument uses 8-bit A/D converters to sample the input signal at a resolution of 255 levels (LSB). On the screen, the waveforms are displayed using twenty-four levels per division on the grid.

##### Valid Data Range

Assuming that the output value from the A/D converter is in the range of 0 to 255, the data point at the center of the screen corresponds to 128 of the A/D output. However, because the full range of the A/D converter is 255 levels, the 256th level on the screen is not used. In addition, the instrument handles the output values of the A/D converter as 0s and 1s. Therefore, the valid data range of the instrument is approximately  $\pm 5.29$  divisions from the center of the screen.

If the vertical axis position is moved after stopping data (waveform) acquisition, the valid data range also moves by the same amount.

### Vertical Position of the Waveform <For the setup procedure, see section 5.3>

Since the instrument is capable of displaying four channels (two channels on the DL1720E) of input waveforms, the waveforms may overlap making them difficult to be observed. In this case, you can change the display position of waveforms along the vertical axis (vertical position) for easier viewing.

The vertical position can be set in the range of  $\pm 4$  divisions.

The vertical sensitivity (V/div) switches around the vertical position (mark).

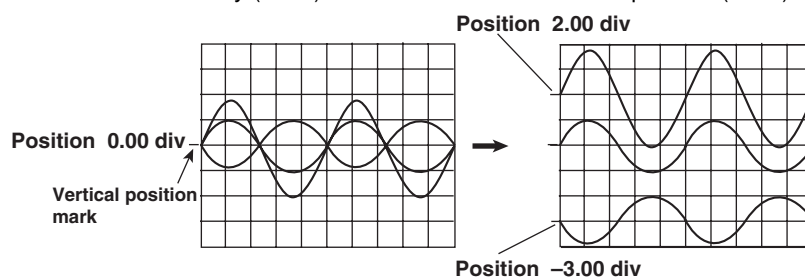

### Input Coupling <For the setup procedure, see section 5.4>

If you wish to observe just the amplitude of an AC signal, it is best to remove the DC component from the input signal. On the other hand, there are times when you wish to check the ground level or observe the entire input signal (both the DC and AC components). In these cases, you can change the input coupling setting. By changing the input coupling, the method used to input the signal to the vertical control circuit (voltage axis) is switched.

The input coupling can be set to one of the following.

#### AC1 MΩ

The input signal is coupled to the attenuator of the vertical control circuit through a capacitor. This setting is used when you wish to observe only the amplitude of the AC signal, eliminating the DC component from the input signal.

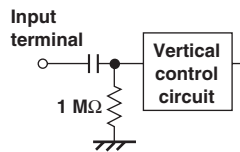

#### DC1 MΩ

The input signal is directly coupled to the attenuator of the vertical control circuit. Use this setting if you wish to observe the entire input signal (DC component and AC component).

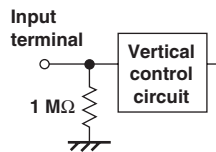

#### DC50 Ω

This setting is similar to DC1 MΩ described above except the input impedance is 50 Ω. Use caution because the allowable maximum input voltage is decreased.

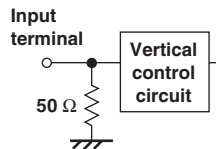

#### GND

The input signal is coupled to the ground, not to the attenuator of the vertical control circuit. You can use this setting to check the ground level on the screen.

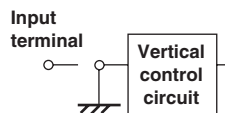

### Probe Attenuation/Current-to-Voltage Conversion Ratio

<For the setup procedure, see section 5.5>

Normally a probe is used in connecting the circuit being measured to the measurement input terminal. Using a probe has the following advantages.

- Avoids disturbing the voltage and current of the circuit being measured.
- Inputs the signal with no distortion.
- Expands the voltage range that the instrument can measure.

The instrument comes standard with 400 MHz passive probes. The probe attenuates the measured signal to 1/10. When using a probe, the attenuation setting on the DL1720E/DL1740E/DL1740EL must be set equal to the probe's attenuation so that the measured voltage can be read directly. When using the 400 MHz Passive Probe (voltage probe) that comes with the instrument, enter a setting of 10:1.

The other voltage probe settings that are available on the instrument are 1:1, 100:1, and 1000:1, and for the current probe, 10 A:1 V (0.1 V/A), and 100 A:1 V (0.01 V/A). When using a probe other than one supplied with the instrument, set the attenuation ratio on the instrument to match that of the probe used.

### Offset Voltage <For the setup procedure, see section 5.6>

When observing a voltage riding on top of a predetermined voltage, an offset voltage can be applied to eliminate the predetermined voltage so that only the changes in the signal can be observed with higher voltage axis sensitivity.

Usually, the offset voltage does not affect the cursor measurement values, the result of the automated measurement of waveform parameters, or the computed values.

However, you can apply the offset voltage to cursor measurement values, the result of the automated measurement of waveform parameters, and the computed values by setting Offset Cancel to ON (see section 15.3).

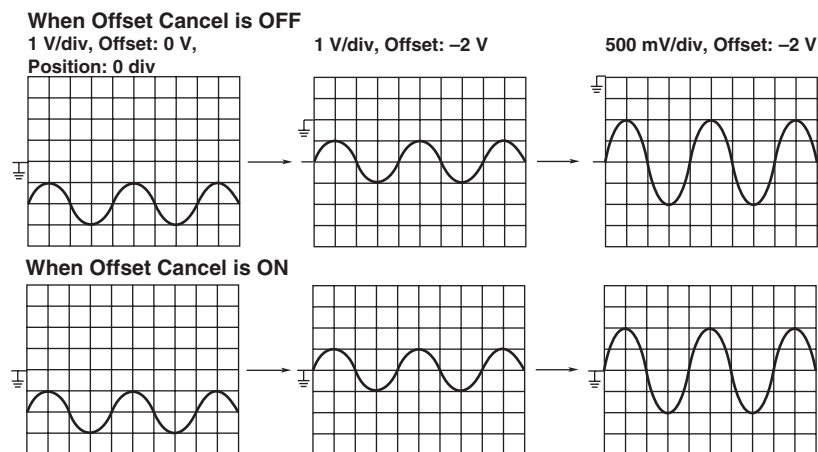

### Bandwidth Limit <For the setup procedure, see section 5.8>

You can set a bandwidth limit at 20 MHz or 100 MHz against the input signal for each channel. You can observe waveforms with the noise components above the specified frequency eliminated.

### Linear Scaling <For the setup procedure, see section 5.9>

You can set the scaling coefficient A, offset value B, and units (UNIT) for the measured values (X) obtained through cursor measurement or automatic measurement of waveform parameters.

For example, this is useful for converting voltage values to current values by multiplying the values measured on the instrument by the voltage ratio of an external voltage divider.

$$Y (\text{UNIT}) = AX + B$$

X: Value before linear scaling

Y: Value after linear scaling

**Horizontal Axis (Time Axis)**

**Selecting the Time Base <For the setup procedure, see section 5.10>**

By default, the sampling timing of waveform data is controlled by the internal clock signal generated from the time base circuit within the instrument (see the block diagram in section 2.1). The timing can also be controlled by a clock signal applied externally. External clock signals are input through the external clock input terminal on the rear panel. The external clock input is useful for observing a signal whose period varies or for observing waveforms by synchronizing to the clock signal of the signal being measured.

**Time Axis Setting <For the setup procedure, see section 5.11>**

When using the internal clock, the time axis scale is set in terms of the time per one grid square (one division). The setting range is 1 ns/div to 50 s/div (or 1ns/div to 5s/div when the record length is equal to 1 kWord). Since the horizontal axis display range is 10 div, the waveform display time is T/div x 10.

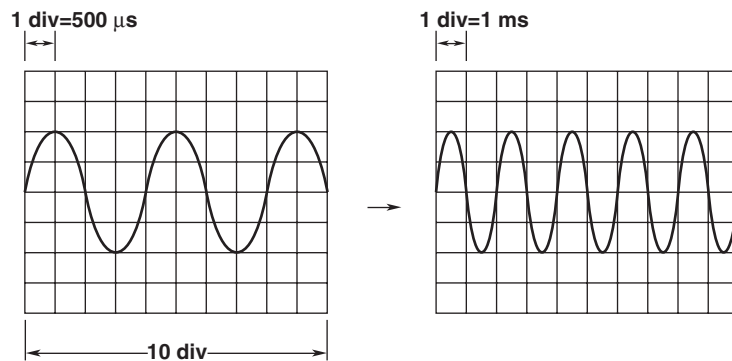

**Note**

**Display along the Time Axis**

Sampled data is acquired to the acquisition memory, and waveforms are displayed based on the stored data.

The number of display lines in ten divisions of the screen (along the time axis) is 500 (250 lines in the zoom waveform display section of Main & Z1 & Z2). Therefore, the waveforms are processed according to the display record length as described below. For more details about the relationship between the time axis, acquisition mode, record length of the acquisition memory, display record length, and other parameters, see appendix 1, "Relationship between the Time Axis, Sample Rate, and Record Length."

- When the display record length is greater than the number of display points  
Multiple data existing on the same display line on the time axis are connected by a line and displayed
- When the display record length is less than the number of display points  
The display is interpolated (see section 2.4).

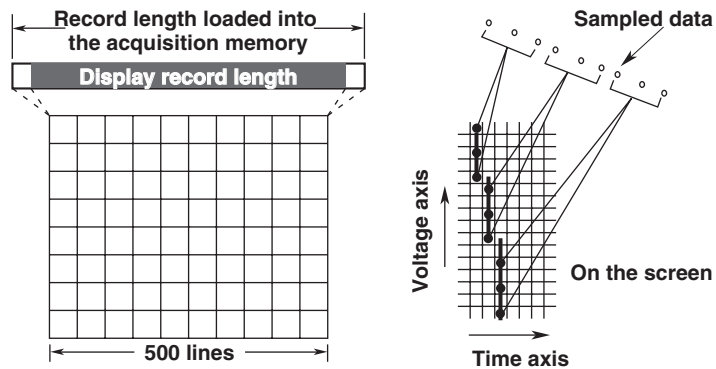

**Relationship between the Time Axis Setting, Sample Rate, and Record Length**

The sample rate and record length of the data loaded into the acquisition memory changes when the time axis setting is changed.

For more details about this relationship, see appendix 1, "Relationship between the Time Axis, Sample Rate, and Record Length."

### Relationship between the Time Axis Setting and Sampling Mode

Depending on the time axis setting, you can switch the mode used to sample the input signal (sampling mode). The time axis settings that allow the sampling mode to be changed vary depending on the acquisition mode and other settings. For more details about this relationship, see appendix 1, "Relationship between the Time Axis, Sample Rate, and Record Length."

#### • Realtime Sampling Mode

By changing the time axis setting, the sample rate changes, allowing sampling of data at up to 1 GS/s (or 500 MS/s when interleave mode is OFF; for a description of interleave mode, see section 7.5). The input signal is sampled sequentially, and the data is stored in the acquisition memory.

In this mode, the instrument can only display waveforms correctly up to one-half the frequency of the sample rate (the number of samples per second, in units of S/s) as defined by the sampling theorem.\* Therefore, this mode is best suited for observing waveforms that undergo slow changes relative to the sample rate.

- \* If the sample rate is comparatively low with respect to the input signal frequency, the harmonics contained in the signal are lost. In this case, some of the harmonics will appear at low frequencies due to the effects described by the Nyquist sampling theorem. This phenomenon is called aliasing. You can prevent aliasing by acquiring waveforms with the acquisition mode set to envelope.

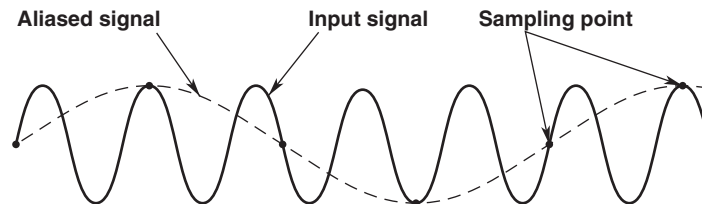

#### • Repetitive Sampling Mode

In repetitive sampling mode, you can set the time axis to a setting that will cause the sample rate to exceed 1 GS/s (2 GS/s when interleave mode is ON). In this mode, one waveform is created from several cycles of a repetitive signal. This is equivalent to sampling the signal at a higher sample rate than the actual sample rate. The maximum apparent sample rate is 100 GS/s on the instrument.

In addition, even in realtime sampling mode, if the relationship of the time axis and the display record length would cause the sample rate to exceed 1 GS/s (or 2 GS/s when interleave mode is ON), the mode automatically switches to repetitive sampling. There are two types of repetitive sampling.

One is sequential sampling in which the data is sampled by intentionally offsetting the sampling points by a certain time with respect to the trigger point. The other is random sampling in which the data that is offset randomly from the trigger point is sampled and resorted with respect to the trigger point. The instrument employs random sampling which enables the waveform before the trigger point (trigger position, see section 2.3) to be observed.

### Time Axis Setting and Roll Mode Display

If T/div is set to a certain range (see appendix 1, "Relationship between the Time Axis, Sample Rate, and Record Length"), the waveforms are displayed in roll mode. In roll mode, the displayed waveform is not updated using triggers (update mode). Rather, the oldest data is deleted as new data is acquired, and the waveform is shifted from right to left on the screen. Roll mode display allows waveforms to be observed in the same way as on a pen recorder. It is useful in observing slowly repeating signals or signals that change slowly. It is also useful in detecting glitches (spikes in the waveform) that occur intermittently.

- \* Roll mode display is also used when the trigger mode is set to Single. However, the displayed waveforms stop when a trigger is activated.

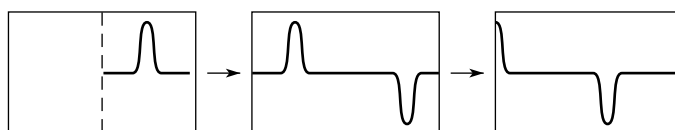



## 2.3 Triggers

### Trigger Source, Trigger Slope, and Trigger Level

#### Trigger Source

Trigger source refers to the signal against which trigger conditions are checked.

#### Trigger Slope

Trigger slope refers to the movement of the signal from a low level to a high level (rising edge) or from a high level to a low level (falling edge). When the slope is used as one of the trigger conditions, it is called a trigger slope. Edge refers to the point where the trigger source slope passes the trigger level (or, when trigger hysteresis (see page 2-13) is specified, the point where the slope passes the hysteresis level).

#### Trigger Level

Trigger level refers to the level at which a trigger is activated when passed by the trigger source.

With simple triggers such as the edge trigger described later, a trigger is activated when the level of the trigger source passes through the specified trigger level.

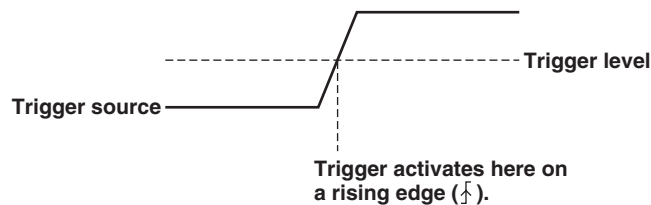

### Trigger Type <For the setup procedure, see chapter 6>

The triggers used on the instrument can be classified into two main types: simple triggers and enhanced triggers.

#### Simple Triggers

This function activates triggers on a single trigger source.

- **Edge Trigger <For the setup procedure, see sections 6.5 to 6.7>**

This function activates a trigger on a single trigger source. It is the simplest kind of trigger. A trigger is activated when the trigger source rises above (rising) or falls below (falling) a specified trigger level.

You can select the trigger source from input signals (CH1 to CH4, or CH1 to CH2 on the DL1720E), the external trigger signal, and the commercial power supplied to the instrument. In the case of commercial power supply signals, a trigger is activated only on the rising edge.

#### Enhanced Triggers

Multiple conditions or a special-purpose condition can be specified as a trigger condition.

- **A->B(N) Trigger <For the setup procedure, see section 6.8>**

A trigger is activated the nth time condition B becomes true after condition A has become true.

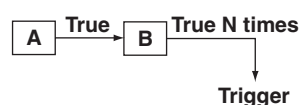

Condition A: CH1 = L, CH2 = L, Enter, Condition B: CH1 = H, CH2 = H, Enter, N = 3  
L: low level, H: high level

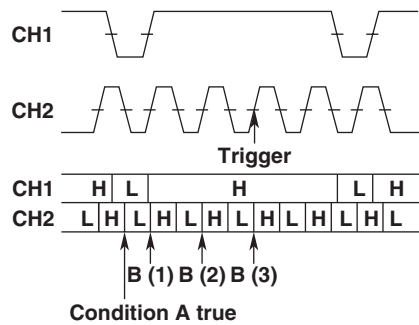

- **A Delay B Trigger <For the setup procedure, see section 6.9>**  
The trigger activates the first time condition B becomes true after condition A has become true and the preset time has elapsed.



Condition A: CH1 = L, CH2 = L, Enter, Condition B: CH1 = H, CH2 = H, Enter, Delay = 1 μs

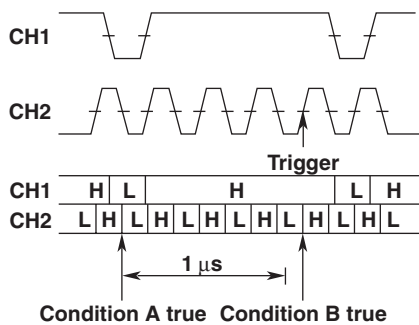

- **Pattern Trigger <For the setup procedure, see section 6.10>**  
With pattern triggers, the multiple trigger sources are set, and a trigger is activated when all of the trigger conditions of the trigger sources are met or when the trigger conditions are no longer met. Trigger conditions are specified by combining the status (high or low) of each trigger source. In addition, one of the trigger sources can be set to the clock signal, and the trigger can be activated in sync with the clock signal.

Condition CH1 = L, CH2 = L, CH3 = H, CH4 = L

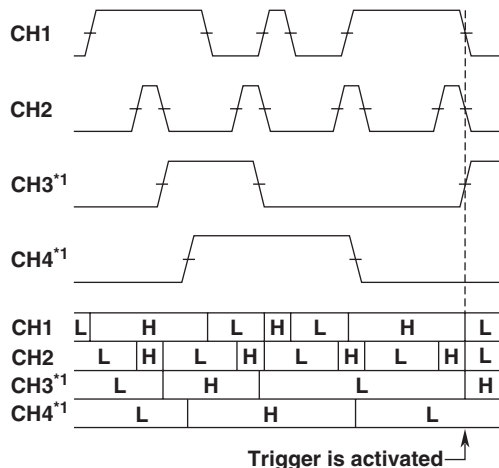

\*1 1. CH3 and CH4 not available on the DL1720E.

## 2.3 Triggers

- **Width Trigger <For the setup procedure, see section 6.11>**

A trigger is activated by determining whether the time width over which the specified condition is met or not met is shorter or longer than the determination time width set in advance. The condition is set on the AND logic of the status (High, Low, or Don't Care) of each channel or the AND logic of the window condition (IN, OUT, or Don't Care) of each channel.

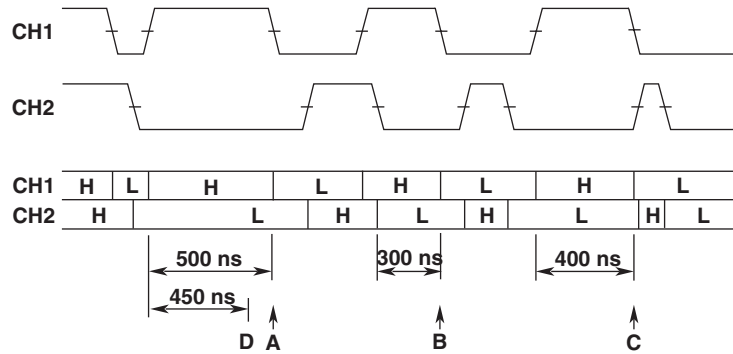

When the condition is set to CH1 = H, CH2 = L, CH3\* = X, CH4\* = X, Condition = True, and Time = 350 ns

Determination Type	Results
Pulse < T	Trigger is activated at point B.
Pulse > T	Trigger is activated at points A and C.
T1 < PLS < T2	When set to Time1 = 350 and Time2 = 450 ns, the trigger activates at point C.
Time Out	When set to Time1 = 450, the trigger activates at point D.

\* CH3 and CH4 not available on the DL1720E.

- **OR Trigger <For the setup procedure, see section 6.12>**

A trigger is activated when any of the edge or window conditions specified on channels 1 through 4 are met. For example, a trigger can be activated on the rising edge of CH1 or CH2.

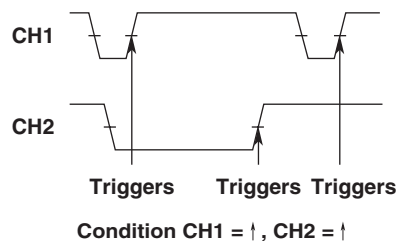

- **Window Trigger <For the setup procedure, see section 6.13>**

A certain voltage range (window) is set and a trigger is activated when the trigger source level enters this voltage range (IN) or exits from this voltage range (OUT). This trigger is used in combination with the OR or Width trigger. The window trigger setting is located in the OR or Width trigger menu.

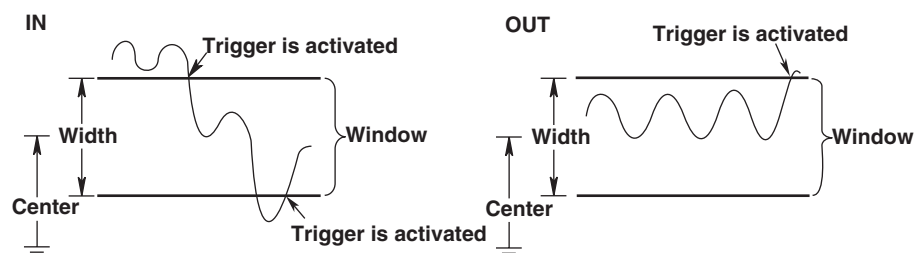

- **TV Trigger** <For the setup procedure, see section 6.14>

This trigger is used when observing video signals. The following broadcasting types are supported: NTSC, PAL, SECAM, 1080/60i, 1080/50i, 720/60p, 480/60p, 1080/25p, 1080/24p, 1080/24sF, and 1080/60p.

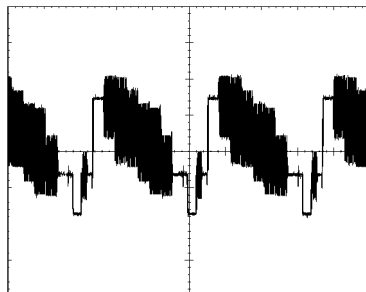

### Trigger Mode <For the setup procedure, see section 6.1>

Sets the conditions for updating the displayed waveforms. The following five trigger modes are available.

#### Auto Mode

If a trigger occurs within a specified amount of time (approximately 100 ms, referred to as the timeout time), the displayed waveforms are updated. If a trigger is not activated within the timeout time, the displayed waveforms are automatically updated.

#### Auto Level Mode

If a trigger occurs within the timeout period, the waveform is displayed in the same fashion as in auto mode. If a trigger is not activated within the timeout time, then the center value of the amplitude of the trigger source is detected, and the trigger level is changed to that value. A trigger is activated using the new value, and the displayed waveforms are updated.

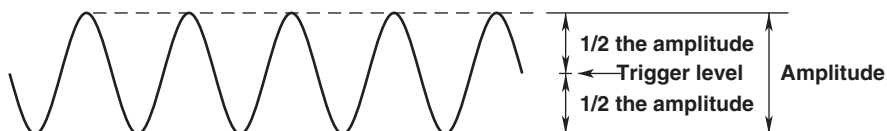

#### Normal Mode

The displayed waveforms are updated only when a trigger occurs. The displayed waveforms are not updated if a trigger does not occur.

#### Single Mode

When a trigger is activated, displayed waveforms are updated only once, then acquisition stops. This mode is useful when you are observing a single-shot signal.

#### Single(N) Mode

Waveforms are acquired and stored in different memory areas each time a trigger is activated the specified number of times. Then, acquisition is stopped, and all the acquired waveforms are displayed. For details on the acquisition method of waveforms in Single(N) mode, see "Sequential Store" on page 2-16.

**Trigger Position <For the setup procedure, see section 6.2>**

When you start waveform acquisition, a trigger is activated according to a specified trigger condition, and the waveform acquired to the acquisition memory is displayed. If the trigger delay described below is set to 0 s, the point at which the trigger is activated (trigger point) and the trigger position match. By moving the trigger position on the screen, you can change the display ratio of the pre-data—the waveform data stored in the acquisition memory before the trigger point (pre-trigger section)—and the postdata—data after the trigger point (post-trigger section).

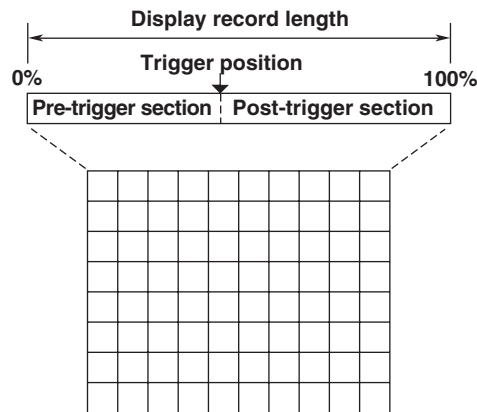

**Trigger Delay <For the setup procedure, see section 6.3>**

Normally, the waveform around the trigger point is displayed. However, by setting a trigger delay, you can display the waveform that is acquired a specified time after the trigger point. The selectable range of trigger delay is 0 to 4 s.

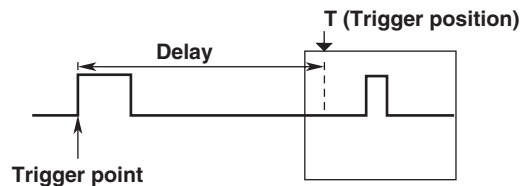

**Trigger Coupling <For the setup procedure, see sections 6.5, 6.8 to 6.13>**

As with the input signals, the input coupling can be switched on trigger sources. Select the input coupling that is suitable for the trigger source signal.

The following two types of input coupling are available for the trigger source signal.

DC: Select this setting when using the source as-is with no processing of the signal.

AC: Select this setting when using the signal with the DC components removed for the trigger source. When this setting is used, a trigger can always be activated on signals whose amplitude is around one division or greater if the trigger level is set to 0 V.

**HF Rejection <For the setup procedure, see sections 6.5, 6.8 to 6.13>**

Turn HF rejection ON when eliminating high frequency components above 15 kHz or 20 MHz from the trigger source. This prevents triggers from being activated at unexpected points due to the effect of high frequency noise.

**Trigger Gate <For the setup procedure, see section 6.16>**

You can control whether to enable a satisfied trigger condition using an external signal. You can also select the status of the external signal that enables the satisfied trigger condition.

**Trigger Hysteresis <For the setup procedure, see sections 6.5, 6.8 to 6.12>**

If there is insufficient trigger level width and noise is present in the trigger source, the trigger point fluctuates each time a trigger is activated. This causes the displayed waveforms to be unstable. Therefore, a given margin (hysteresis) is added to the specified trigger level.

You can select  $\nabla$  (narrow hysteresis) or  $\nabla$  (wide hysteresis) on the instrument. When set to  $\nabla$ , the hysteresis widens thereby reducing the fluctuation of the trigger point caused by noise. Thus, a stable waveform display is achieved. However, this setting tends to make the trigger point ambiguous. On stable waveforms without noise, set the  $\nabla$  hysteresis to make the trigger point more accurate.

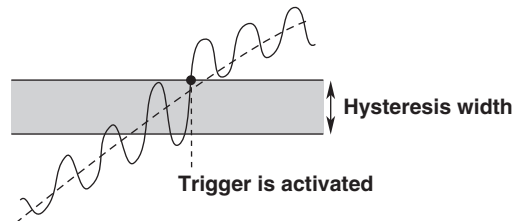
**Trigger Hold Off <For the setup procedure, see section 6.4>**

The trigger hold-off function temporarily stops detection of the next trigger once a trigger has been activated. This function is useful when observing a pulse train signal, such as a PCM code and you wish to display the waveform in sync with repetitive cycles, or when using the history memory function described later (see page 2-16) and you want to change the waveform acquisition period.

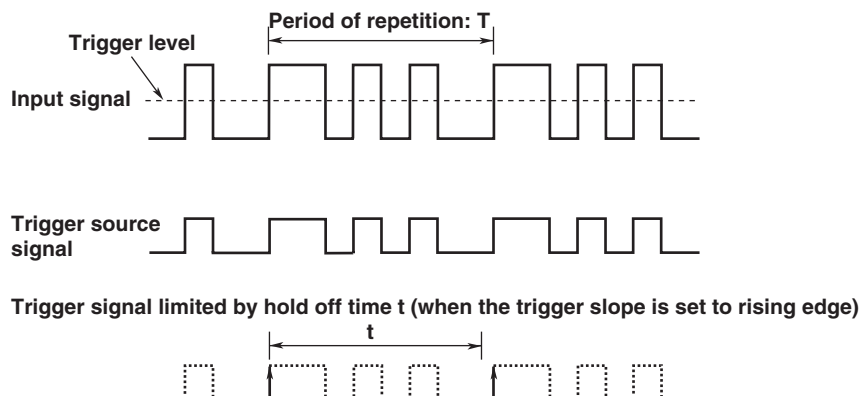
**Action-on-Trigger <For the setup procedure, see section 6.15>**

A specified action can be executed each time a trigger is activated. You can select from various actions including sounding of a buzzer, saving of waveform data or screen image data, printing of screen image data, or transmission of e-mail messages (when the Ethernet interface option is installed).

## 2.4 Waveform Acquisition and Display Conditions

### Record Length <For the setup procedure, see section 7.2>

The term record length refers to the number of data points acquired per channel in the acquisition memory.

The record lengths that can be specified (specified record length) are 1 kW (1000 points), 10 kW, 50 kW, 100 kW, 250 kW, 500 kW, 1 MW, 2 MW, 4 MW, and 8 MW. The maximum record length that can be specified varies depending on the model and interleave mode setting.

Displayed record length refers to the number of these data points that are actually displayed on the screen. When the time axis setting is changed, the sample rate and display record length change (see appendix 1).

In most cases, the displayed record length is identical to the (acquisition) record length. For certain time-axis settings, however, the lengths become different (see appendix 1).

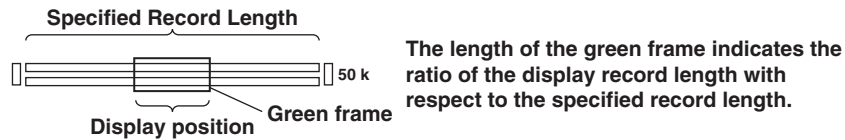

### Interleave Mode <For the setup procedure, see section 7.3>

This mode allocates the memory of even channels to the odd channels (for example allocating the memory of CH2 to CH1) to enable the use of twice the normal memory.

When interleave mode is turned ON, even channels can no longer be used, but parameters such as the history memory, acquisition count of sequential store, and record length can be set twice their normal values.

In addition, since two A/D converters can be used to sample a single input signal and raise the maximum sample rate, a sample rate of 2 GS/s can be achieved in realtime sampling mode.

For the relationship between interleave mode, time axis, record length, and sample rate, see appendix 1.

### Sampling Mode <For the setup procedure, see section 7.4>

As explained in “Relationship between the Time Axis Setting and Sampling Mode” in section 2.2, the sampling mode can be switched between realtime sampling mode and repetitive sampling mode depending on the time axis and record length settings. The time axis range that allows repetitive sampling mode varies depending on the acquisition setting. For details, see appendix 1.

### Acquisition Mode <For the setup procedure, see section 7.5>

When storing sampled data in the acquisition memory (see “Signal Flow” in section 2.1), it is possible to perform processing on data and display waveforms based on the processed data. The following four types of data processing are available.

#### Normal Mode

In this mode, sampled data is stored in the acquisition memory without processing.

**Averaging Mode**

Averaging is a process in which waveforms are acquired repeatedly to obtain the average of waveform data at the same time point (the same time in relation to the trigger point).

The instrument takes the exponential or simple average of the waveform data and writes the results to the acquisition memory. The averaged data is then used to generate the display.

You can set an average count of Infinite for exponential averaging, or in the range from 2 to 65536 (in 2<sup>n</sup> steps where n is a natural number) for simple averaging.

Set the attenuation constant for exponential averaging in the range from 2 to 256 (2<sup>n</sup> steps where n is a natural number).

**Exponential averaging (when set to infinite)**      **Simple average (when set to 2 to 65536)**

$$A_n = \frac{1}{N} \{(N-1)A_{n-1} + X_n\}$$

A<sub>n</sub> : n<sup>th</sup> averaged value  
X<sub>n</sub> : n<sup>th</sup> measured value

N : Attenuation constant (2 to 256, 2<sup>n</sup> steps)

$$AN = \frac{\sum_{n=1}^N X_n}{N}$$

X<sub>n</sub> : n<sup>th</sup> measured value

N : Average count (acquisition count, 2<sup>n</sup> steps)

**Envelope Mode**

In normal mode and averaging mode, the sample rate (the number of times data is acquired per second in the acquisition memory) drops if T/div is increased (see appendix 1). However, in envelope mode, the maximum and minimum values are determined from the data sampled at 400 MS/s (or 800 MS/s or 1GS/s when interleave mode is ON) at time intervals two times that of the sampling period of normal mode, and are stored as pairs in the acquisition memory.

Envelope mode is useful when you want to avoid aliasing (see section 2.2), since the sample rate is kept high irrespective of the time axis setting. It is also useful when you want to detect glitches (pulse signals which rise very fast) or display an envelope of a modulating signal.

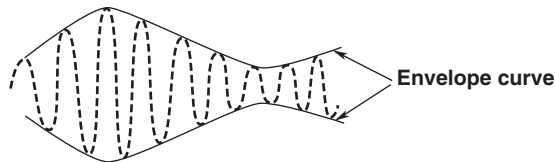

**Box Average**

The moving average of the data sampled at 400 MS/s (or 800 MS/s or 1GS/s when interleave mode is ON) is determined, stored in the acquisition memory, and displayed. Box averaging is useful for eliminating small amounts of noise from the input signal. It can also remove noise from a single-shot signal.

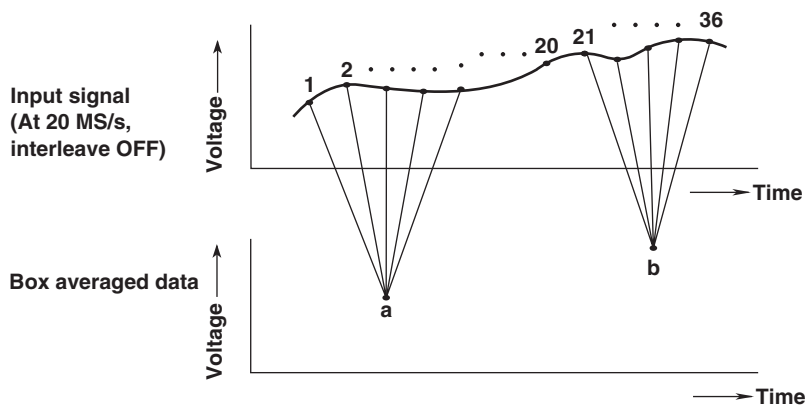



**Sequential Store <For the setup procedure, see section 7.6>**

This function stores waveform data in the acquisition memory the specified number of times and displays the data when in realtime sampling mode. The operation stops when acquisition is finished. This function operates when the trigger mode is set to Single(N). The maximum number of waveform acquisitions of sequential store varies from 1 to 2048 depending on the specified record length, interleave mode, and model. A record length of one waveform (the amount of one acquisition on one channel) is the same as the maximum display record length.

Once the specified number of waveforms have been stored, you can display any of the waveforms individually or all of them together. This function is useful when capturing the changes in the waveform over time. Waveforms are not displayed while waveform acquisition is in progress.

The figure below shows an example when data is sequentially stored one hundred times.

**Display example when the acquisition count is 100**

- Display all waveforms (when selecting ALL)
- Display the newest waveform (when Select Record No. = 0)
- Display the oldest waveform (when Select Record No. = -99)

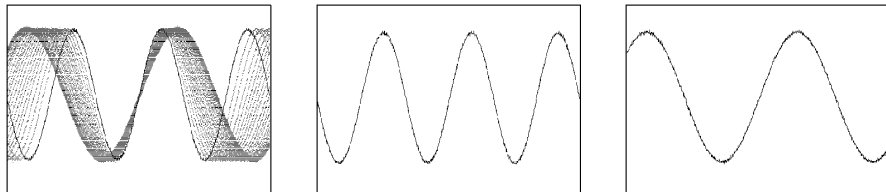

**History Memory <For the setup procedure, see section 10.1>**

When waveforms are being measured, the waveform data stored in the acquisition memory as a result of a trigger being activated is displayed as waveforms on the instrument screen. When triggers are continuously activated and waveforms are acquired, it is impossible to stop the measurement in time when an abnormal waveform appears (newer waveforms appear on the screen). Normally, abnormal waveforms in the past cannot be displayed. However, by using the history memory function, the past waveform data (history waveforms including the current displayed waveform) stored in the acquisition memory can be displayed when waveform acquisition is stopped. You can display a specified history waveform from the data (up to 2048 waveforms, or the number of triggers) stored in the acquisition memory. In addition, a certain history waveform can be searched (see section 2.6).

The number of waveforms N that can be acquired and held as history waveforms varies from 1 to 2048 depending on the record length, interleave mode setting, and model. If the number of waveforms N that can be acquired and held is exceeded, the oldest history waveform is cleared. The waveform currently displayed on the screen (newest waveform) is counted as the 1st waveform, and up to N-1 waveforms in the past can be displayed.

The following figure indicates an example when N = 1024.

**Holds waveform data of the last 1024 triggers**

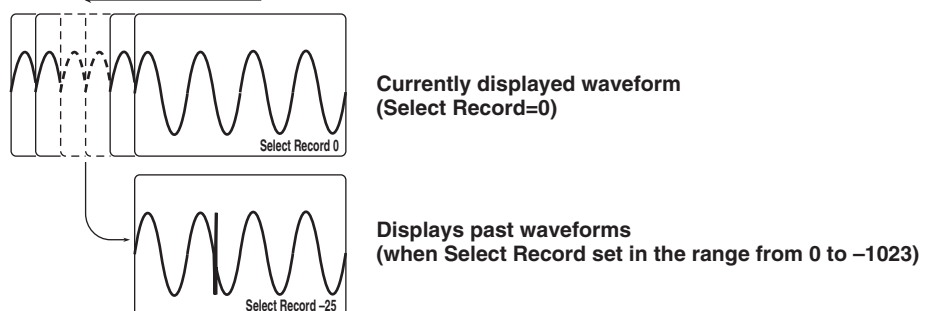

**Display Format <For the setup procedure, see section 8.1>****Splitting the Screen**

The screen can be split evenly so that input waveforms and computed waveforms can be easily viewed. The screen can be divided into the following:

Single (no division), Dual (two divisions), Triad (three divisions), Quad (four divisions), and Hexa (six divisions)\*

\* Quad (four divisions) and Hexa (six divisions) are not available on the DL1720E.

**Waveform Mapping**

You can select one of the following for the mapping of the input channels to the divided windows.

Auto: Waveforms whose input channels are turned ON are assigned in order from the top.

Fixed: Waveforms are assigned in order from the top regardless of whether the input channels are turned ON or OFF.

User: Channels are assigned in order from the top to an arbitrary number of screen divisions regardless of whether the input channels are turned ON or OFF.

**Display Interpolation <For the setup procedure, see section 8.2>**

In interpolation areas where less than 500 points of data exists in ten divisions along the time axis (or less than 250 points in the zoom display section when waveforms are zoomed in Main&Z1&Z2), a continuous waveform cannot be displayed because there are not enough sampled points. In this case, the waveform is displayed by interpolating between data points. You can select one of the following interpolation methods.

**Linear Interpolation**

Linearly interpolates between two points.

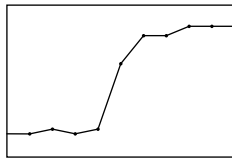
**Sine Interpolation**

Generates interpolation data using the function  $\frac{\sin x}{x}$ , then interpolates between two points using the resulting sine curve. Sine interpolation is suitable for observing sine waves or similar waves.

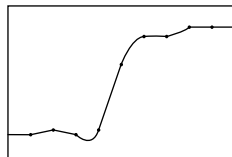
**Pulse Interpolation**

Interpolates between two points in a step pattern.

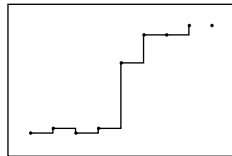
**Interpolation OFF**

Displays discrete dots without performing interpolation.

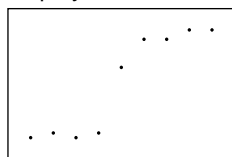

**Accumulated Display <For the setup procedure, see section 8.3>**

The display time of old waveforms can be set longer than the waveform update period, so that newer waveforms appear overlapped (accumulated) on older waveforms. Accumulated display is useful when observing jitters and temporary turbulence in waveforms.

The following two modes are available.

- Persist: Accumulates waveforms using a single color for each channel. The intensity is gradually reduced, and the waveform disappears after the specified time.
- Color: Accumulates waveforms using eight colors indicating data frequency information.

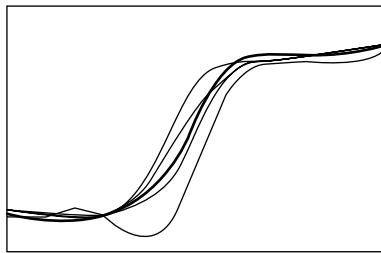

**Zooming the Waveform <For the setup procedure, see section 8.4>**

The displayed waveform can be expanded along the time axis. This function is useful when the waveform acquisition time is set long and you wish to observe a particular section of the waveform closely.

Zooming is not possible if the number of displayed points on the screen is less than or equal to 50.

Zoomed waveforms of up to two locations can be displayed simultaneously (dual zoom). Below are the combinations of the normal waveform and zoomed waveform displays when the normal waveform display frame is denoted as Main and the two zoom waveform display frames are denoted as Z1 and Z2.

<Main>		<Main>		<Z1>	<Z1>
<Z1>	<Z2>	<Z1> or <Z2>		<Z2>	or <Z2>

When displaying Main (main waveform) and Z1 (zoomed waveform), or Main and Z2 simultaneously, a zoom box indicating the zoom position is displayed within the main waveform display frame. The center of the zoom area corresponds to the center of the zoom box. For a display example, see “Display Example When Displaying Zoom Waveforms” in section 1.3.









**X-Y Waveform Display <For the setup procedure, see section 8.5>**

The relationship between the levels of two input signals can be observed by taking the level of the waveform assigned to the X-axis (horizontal axis) and the level of another waveform (whose display is turned ON) assigned to the Y-axis (vertical axis).

Simultaneous observation of X-Y waveforms and normal T-Y waveforms (waveform display using time axis and level) is possible.

You can use the X-Y waveform display function to measure the phase angle between two sine wave signals. For example, the waveform that appears when two sine waveforms are shown on the X-Y display is called a Lissajous waveform. From this waveform, the phase angle can be obtained. For a display example, see "Display Example When Displaying X-Y Waveforms" in section 1.3.

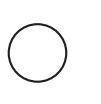
Lissajous waveform

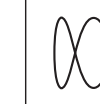
Phase angle 0°			
Phase angle 45°			
Phase angle 90°			
Frequency ratio (X:Y)	1:1	1:2	1:3

**Snapshot <For the setup procedure, see section 8.6>**

When the trigger mode is set to a mode other than Single or Single(N), the displayed waveforms are periodically updated or displayed in roll mode (see page 2-7). Therefore to hold the waveform you are currently viewing, you must stop waveform acquisition. By using the snapshot function, you can temporarily hold the waveform (snapshot waveform) that would be cleared when the screen is updated on the screen. The snapshot waveform is displayed in white, allowing for easy comparison against the updated waveform. The snapshot waveform is a screen image waveform. You can save, load, and print the screen image data, but cursor measurements, automated measurement of waveform parameters, zoom, and computation cannot be performed on it.

Snapshot waveforms

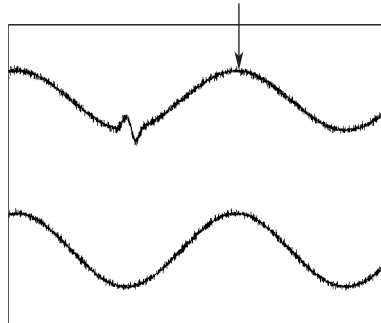
**Clear Trace <For the setup procedure, see section 8.6>**

You can clear the snapshot waveform and restart averaging and accumulation using one key operation. Pressing the SHIFT key followed by the SNAP SHOT key clears only the snapshot waveforms.

### Other Waveform Display Settings

**Graticule <For the setup procedure, see section 8.7>**

You can change the type of graticule that is displayed to suit your needs. For example, you can show a grid on the screen or show only the frame.

**Displaying Scale Values <For the setup procedure, see section 8.8>**

The upper and lower limits (scale values) of the vertical and horizontal axis of each channel can be displayed. For a display example, see “Normal Display Screen” in section 1.3.

**Displaying Waveform Labels <For the setup procedure, see section 8.9>**

You can arbitrarily set a waveform label for the waveforms input on each channel using up to eight characters. For a display example, see “Normal Display Screen” in section 1.3.

**Translucent Display <For the setup procedure, see section 8.10>**

The dialog boxes that appear during setup operation become translucent allowing the contents underneath the dialog boxes to be seen.

## 2.5 Waveform Computation

### Addition, Subtraction, and Multiplication <For the setup procedure, see section 9.2>

Addition, subtraction, and multiplication can be performed between waveforms of CH1 and CH1 to CH4; CH2 and CH1 to CH4; CH3 and CH1 to CH4 or Math1; and CH4 and CH1 to CH4 or Math1 (or between CH1 and CH1 to CH2, or CH2 and CH1 to CH2 on the DL1720E). The computed result becomes the Math1 or Math2 waveform (or the Math1 waveform for the DL1720E).

Addition (+) and subtraction (–) are useful functions when comparing waveforms against a standard signal, checking the signal logic, or comparing the phase. Multiplication (×) is a useful function when applying a voltage signal and a current signal and checking the power waveform.

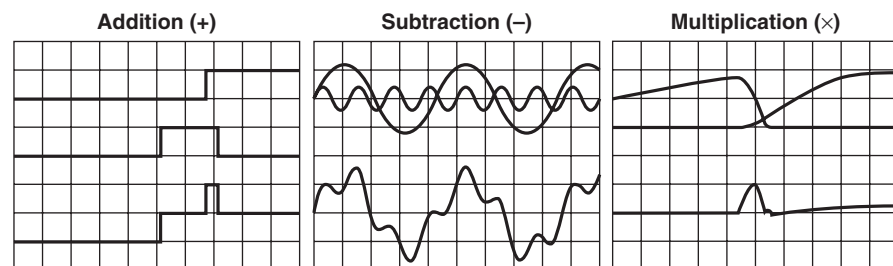

### Binary Computation <For the setup procedure, see section 9.3>

The selected waveform can be converted to a digital waveform of 0s and 1s with respect to the specified threshold level. This computation can be performed on the waveforms of CH1 to CH4 and Math1 (or CH1 to CH2 on the DL1720E).

### Inversion <For the setup procedure, see section 9.4>

The voltage axis can be inverted on the display by multiplying the measured data by -1. This computation can be performed on the waveforms of CH1 to CH4 and Math1 (or CH1 to CH2 on the DL1720E).

### Differentiation (Diff) and Integration (Integ) <For the setup procedure, see section 9.5>

Differentiates or integrates the waveform of the selected channel. This computation can be performed on the waveforms of CH1 to CH4 and Math1 (or CH1 to CH2 on the DL1720E).

### Phase Shift <For the setup procedure, see section 9.8>

You can shift the phase of the displayed waveforms on CH1 to CH4 (or CH1 and CH2 on the DL1720E), and use the phase-shifted data in calculations.

### Scaling the Computed Waveform <For the setup procedure, see section 9.2>

Normally, auto scaling is performed when computed waveforms are displayed. However, you can also select manual scaling.

When auto scaling is used, the vertical center line level<sup>1</sup> and sensitivity<sup>2</sup> of the display frame are automatically determined from the computed waveform, and the computed waveform is displayed.

When manual scaling is used, you can set the center and sensitivity as necessary.

1. Voltage in the case of voltage waveforms.
2. Voltage per division in the case of voltage waveforms.

**Power Spectrum Display <For the setup procedure, see section 9.6>**

The power spectrum of the input signal can be computed and displayed by taking the FFT (Fast Fourier Transform). This is useful when you wish to check the frequency distribution of the input signal.

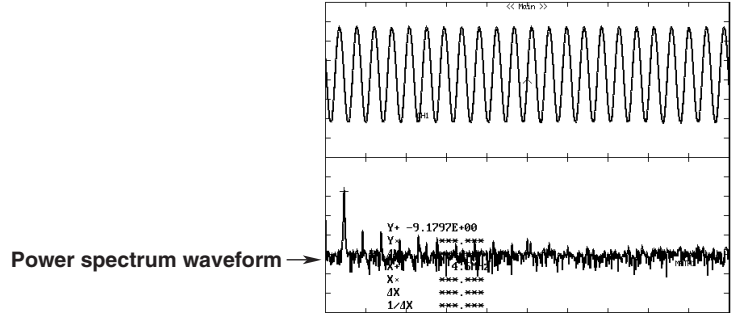

You can select the time window from Rectangular, Hanning, and Flattop. The rectangular window is best suited to transient signals, such as impulse waves, which attenuate completely within the time window.

The Hanning and flattop windows allow continuity of the signal by gradually attenuating the parts of the signal located near the ends of the time window down to the 0 level. Hence, it is best suited to continuous signals. With the Hanning window, the frequency resolution is high compared to the flattop window. However, the flattop window has a higher level of accuracy. When the waveform being analyzed is a continuous signal, select the proper window for the application.

FFT is performed on 1000 or 10000 points of measured data. The data is converted to half the specified number of points and displayed.

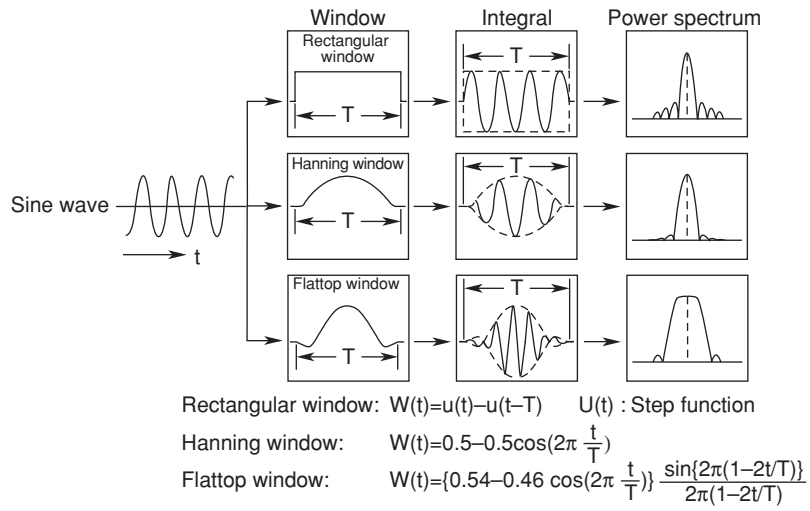

**FFT Function**

Given that the complex function resulting after the FFT is  $G = R + jI$ , the power spectrum can be expressed as follows:

<b>DC component</b>	<b>AC component</b>
$10 \log(R^2 + I^2)$	$10 \log\left(\frac{R^2 + I^2}{2}\right)$

R: Real Part  
 I: Imaginary Part  
 Reference value (0 dB) of the logarithmic magnitude (Log mag): 1 Vrms<sup>2</sup>

## 2.6 Analyzing, and Searching Waveforms

### Displaying History Waveforms <For the setup procedure, see section 10.1>

Past waveform data (history waveforms) stored in the acquisition memory can be displayed when waveform acquisition is stopped. You can display a specified history waveform from the data (up to 2048 waveforms, or the number of triggers) stored in the acquisition memory.

The number of waveforms N that can be acquired and held as history waveforms varies from 1 to 2048 depending on the record length and interleave mode settings. The waveform currently displayed on the screen (newest waveform) is counted as the 1st waveform, and up to N-1 waveforms in the past can be displayed.

### History Search

You can search history waveforms that meet specified conditions when waveform acquisition is stopped.

#### Zone Search <For the setup procedure, see section 10.2>

You can search history waveforms that pass or do not pass a specified search zone.

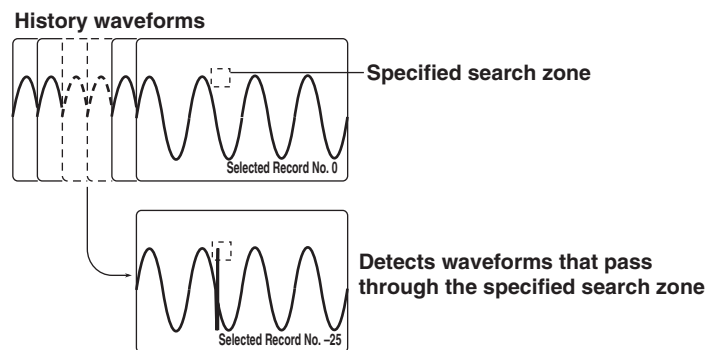

#### Waveform Parameter Search <For the setup procedure, see section 10.3>

You can search history waveforms that meet or do not meet the specified search parameter conditions.

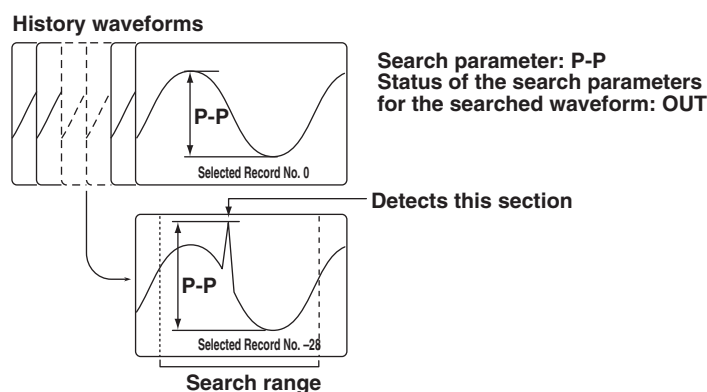



**Search and Zoom <For the setup procedure, see section 10.4>**

When waveform acquisition is stopped, you can search the displayed waveforms (within the display record length, see appendix 1) and display the waveforms that match the search conditions expanded on the screen.

**Edge Search**

Search is performed on the number of times the waveform goes above or below (rising or falling) a specified level.

Search condition Edge: rising edge and detection count: 2

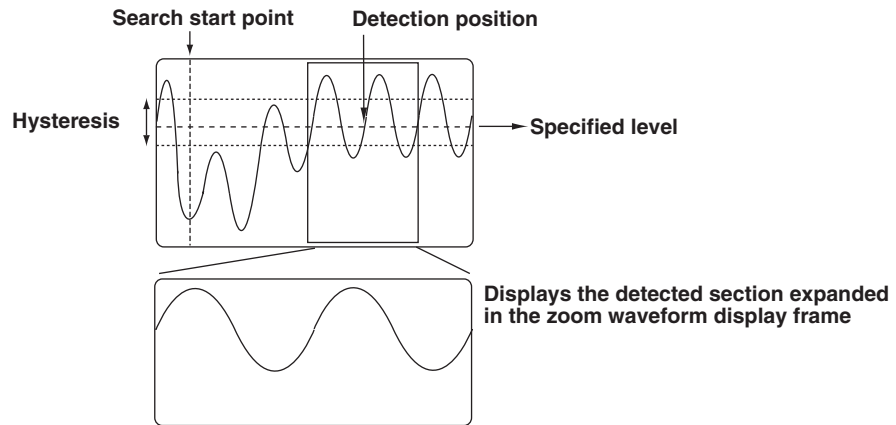

**Serial Pattern Search**

Search is performed on whether the serial status pattern of the waveform (status pattern of the waveform that changes over time) is the same as the status pattern set in advance. You can also set whether the timing used to detect the waveform status (up to sixty-four statuses) is synchronized to a selected clock signal or is performed at certain time intervals.

Condition Clock channel: CH1, slope on which to check the status: rising, and searched waveform: CH2

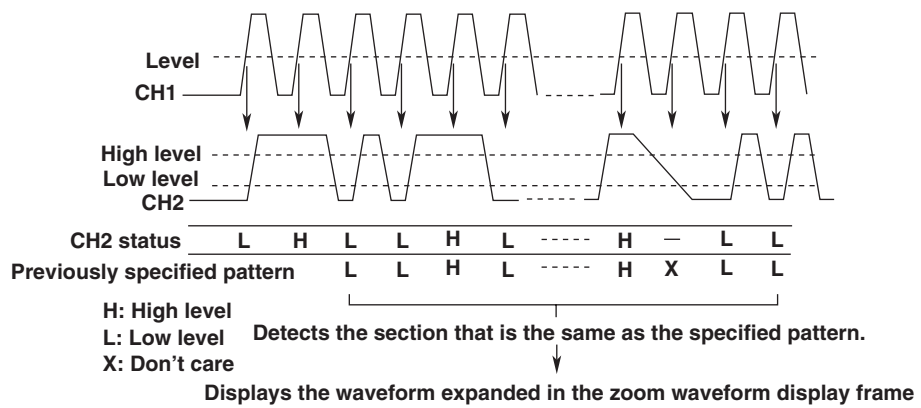

**Parallel Pattern Search**

Search is performed on whether the parallel status pattern of the waveform (each status pattern at the same point in time) is the same as the status pattern set in advance. You can also set whether the waveform status is detected in sync with the selected clock signal and whether statuses of all waveforms are detected.

**Conditions** Clock channel: None, CH1 = L, CH2 = L, CH3\* = H, CH4\* = L, Math1: X, Math2: X

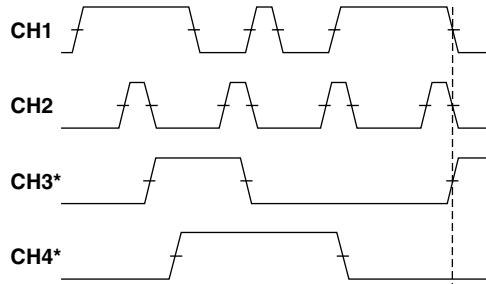

CH1	L	H	L	H	L	H	L	L
CH2	L	H	L	H	L	H	L	H
CH3*	L	L	H	L	L	L	L	H
CH4*	L	L	H	L	L	L	L	H

H: High level  
L: Low level  
X: Don't care

↑ Detects this position and displays the waveform expanded in the zoom waveform display frame

\* CH3 and CH4 not available on the DL1720E.

**Conditions:** Clock channel: CH1, falling slope, CH2: L, CH3\*: H, CH4\* L

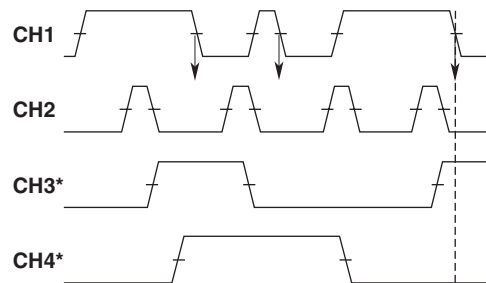

CH2	L	H	L	H	L	H	L	H
CH3*	L	L	H	L	L	L	L	H
CH4*	L	L	H	L	L	L	L	H

H: High level  
L: Low level

↑ Detects this position and displays the waveform expanded in the zoom waveform display frame

\* CH3 and CH4 not available on the DL1720E.

## 2.6 Analyzing, and Searching Waveforms

---

### Pulse Width Search

Search is performed on whether the pulse width of the waveform above or below a specified level is shorter or longer than the specified determination time.

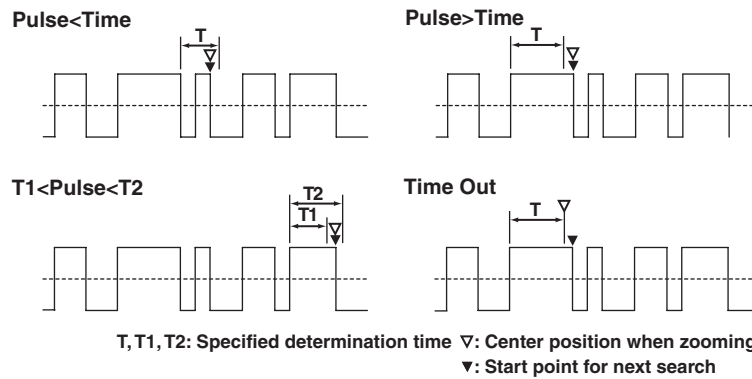

### Auto Scroll

The zoom position automatically moves (auto scroll) in the specified direction. You can confirm the zoomed waveform and stop the scroll operation at an arbitrary position.

**Cursor Measurements <For the setup procedure, see section 10.5>**

Cursors can be placed on the displayed waveform (within the display record length. See appendix 1) and various types of measured values at the cross point of the cursor and waveform can be displayed. Four types of cursors are available.

**Horizontal Cursors**

Two broken lines (horizontal cursors) are displayed on the horizontal axis (X-axis). The Y-axis values at the cursor positions can be measured. The level difference between cursors can also be measured.

**Vertical Cursors**

Two broken lines (vertical cursors) are displayed on the vertical axis (Y-axis). The time (X-axis values) from the trigger point to each vertical cursor and the time difference between the vertical cursors can be measured. In addition, the signal level (Y-axis value) at each cursor position and the level difference between the cursors can be measured.

**Marker Cursors**

Four markers are displayed on the selected waveform. The level (Y-axis value) at each marker, the time (X-axis value) from the trigger position, and the level difference and time difference between markers can be measured.

**Angle Cursors (Degree)**

Measurements can be made by converting the time axis values into angles. The zero point (position of reference cursor Ref1) and the end point (position of the reference cursor Ref2) are set on the X-axis and an angle (reference angle) is assigned to the width of Ref1 and Ref2. The positions of the two angle cursors (Cursor1 and Cursor2) can be converted into angles from the specified reference angle and measured.

When using vertical cursors

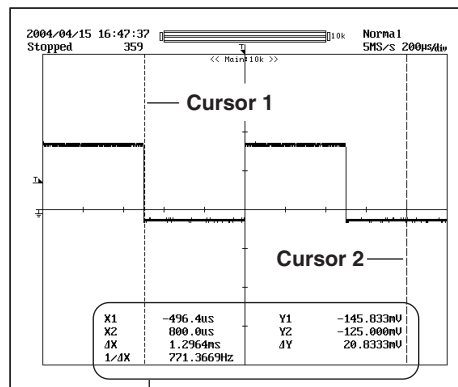

Value measured with the cursor

When using marker cursors

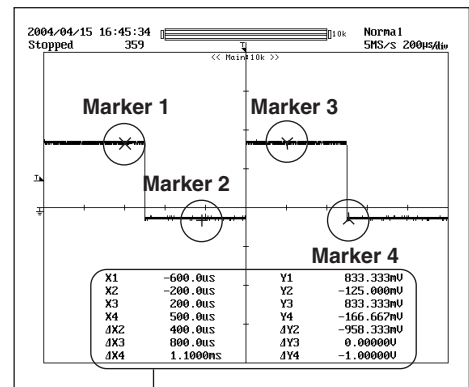

Values measured with the cursor

**Automated Measurement of Waveform Parameters**

**Automated Measurement of Waveform Parameters <For the setup procedure, see section 10.6>**

You can automatically perform measurement on channels of specified rise times, pulse widths, and other parameters. Up to twenty-seven items can be measured. Up to twelve parameters from the selected parameters of all the channels can be displayed. Measurement is performed on the data stored in the acquisition memory.

**Statistical Processing <For the setup procedure, see section 10.7>**

You can perform statistical processing on the automatically measured values above. The following five statistics can be determined on the two measured values of automated measurement parameters.

- Maximum value (Max)
- Minimum value (Min)
- Average value (Avg)
- Standard deviation (Sdv)
- Number of measured values used in the statistical processing (Cnt)

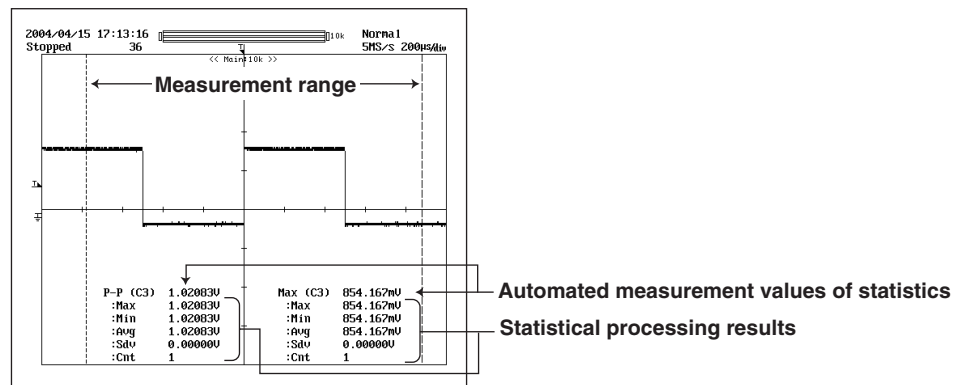

The following three statistical processing methods are available.

- **Normal Statistical Processing**  
Statistical processing is performed on all acquired waveforms while acquiring waveforms.
- **Statistical Processing by Cycle**  
The displayed waveform is separated into automatically determined cycles, and statistical processing is performed on the measured values within each cycle. Statistical processing is performed from the oldest data of the displayed waveforms.

When Own is selected as the waveform used to determine the cycle

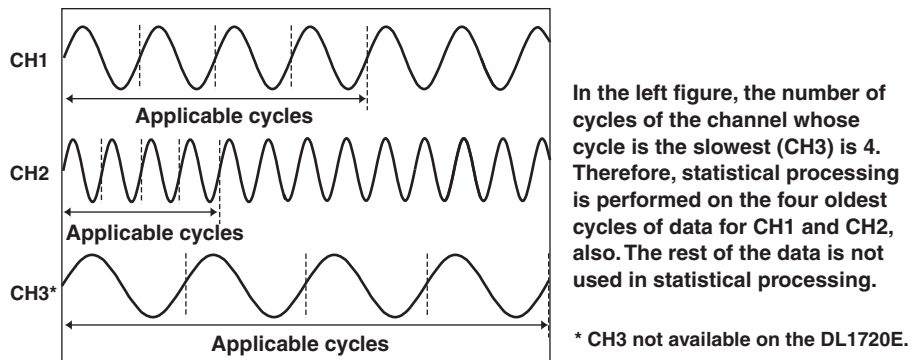

- **Statistical Processing of History Waveforms**  
Automated measurement is performed on the history waveforms in the selected range and statistical processing is performed. Statistical processing is performed from the oldest data.

**Automated Measurement of Waveform Parameters on Dual Areas <For the setup procedure, see section 10.8>**

You can specify two areas and perform automated measurement of waveform parameters on each area. You can also perform computation on the parameters determined in the two areas. Per cycle statistical processing is not possible.

**GO/NO-GO Determination <For the setup procedure, see sections 10.9 to 10.11>**

The GO/NO-GO function is useful when you want to inspect signals and track down abnormal symptoms on a production line making electronic equipment. The NO (NO-GO) condition is set (whether the waveform enters the previously specified range), and a certain operation is performed when the condition is met.

There are two methods in making the determination: a method in which a waveform zone is set on the screen and a method in which a waveform parameter range is specified. You can select from various actions for the NO-GO operation including sounding of a buzzer, saving of waveform data or screen image data, printing of screen image data, or transmission of e-mail messages (when the Ethernet interface option is installed). Also, you can output determination results signals externally on the GO/NO-GO determination output terminal.

## 2.7 Communication

### Communication Using Commands (GP-IB, USB, or Ethernet)

<For the setup procedure, see the Communication Interface User's Manual CD-ROM>

The instrument comes standard with a GP-IB and a USB interface. An Ethernet interface is available as an option. Using communication commands, you can output waveform data to a PC for data analysis or control the instrument using an external controller to carry out waveform measurements.

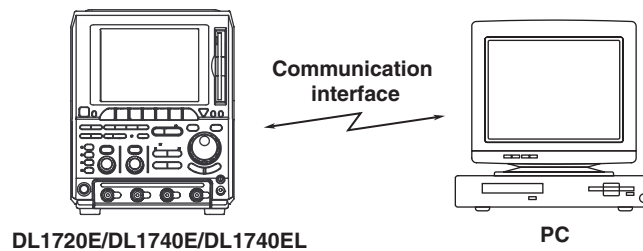

### Saving and Loading Data from a Network Drive (FTP Client)

<For the setup procedure, see section 13.3>

As with the built-in storage medium and external USB devices, waveform and setup data can be saved and loaded and screen image data can be saved to an FTP server\* on the network.

\* PC or workstation on which the FTP server function is running.

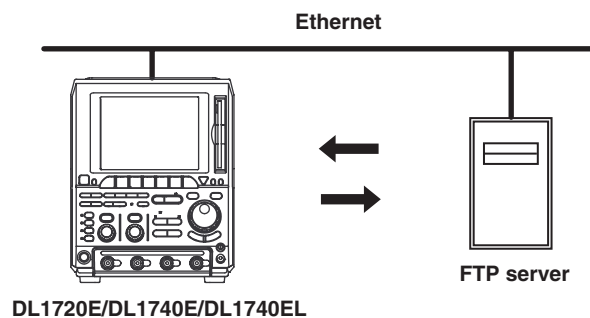

### Printing on a Network Printer (LPR Client) <For the setup procedure, see section 13.4>

The screen image can be printed on a network printer in the same way as the built-in printer (optional) or a printer connected via the USB PERIPHERAL interface.

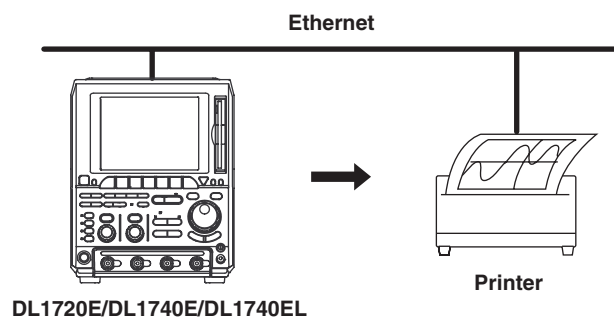

**Transmitting E-Mails (SMTP Client) <For the setup procedure, see section 13.5>**

Information from the instrument can be transmitted periodically in an e-mail message to a specified mail address. You can also transmit information such as the trigger time in an e-mail message as an action for the GO/NO-GO determination or action-on-trigger.

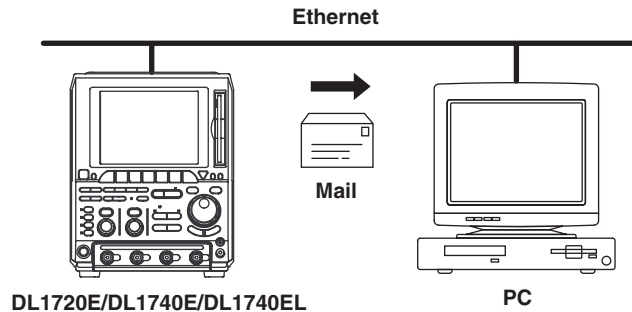
**Accessing the instrument from a PC or Workstation (FTP Server) <For the setup procedure, see section 13.6>**

The instrument can be accessed from an FTP client on the network, and the files on the built-in storage medium of the instrument or external USB device can be retrieved.

\* PC or workstation on which the FTP client function is running.

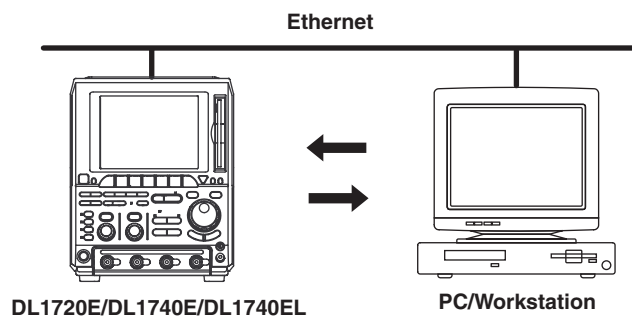
**Web Server <For the setup procedure, see section 13.7>**

The instrument can function as a Web server. By displaying the Web page of the DL1720E/DL1740E/DL1740EL, file transfer, monitoring of displayed waveforms, basic DL1720E/DL1740E/DL1740EL setup operation, and the retrieval operation of waveform data are possible.

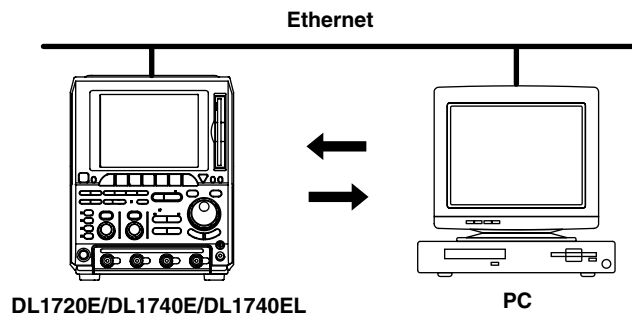
**Using the Instrument as a Network Drive <For the setup procedure, see section 13.11 >**

The external storage medium of the instrument can be used as a network drive from a PC running Windows XP.



## 2.8 Other Useful Functions

### Entering Values and Text Using the USB Keyboard <For the setup procedure, see section 4.3>

You can connect a USB keyboard and enter file names and comments. In addition, the functions of each key on the front panel of the instrument are assigned to the keys on the keyboard. Thus, the keyboard can be used to carry out operations that are the same as the key operations on the instrument. For the key assignments, see appendix 5.

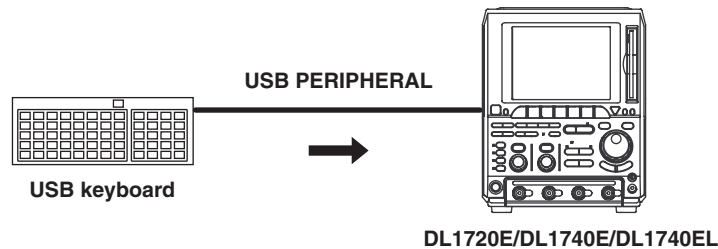

### Operating the Instrument Using a USB Mouse <For the setup procedure, see section 4.3>

You can use a USB mouse to operate the instrument as you would using the front panel keys. In addition, you can point to a desired item on a menu and click the item. This is analogous to pressing a soft key corresponding to a menu and pressing the SELECT key.

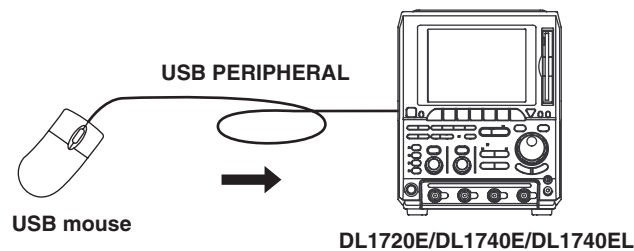

### Initialization <For the setup procedure, see section 4.4>

You can perform initialization using a simple panel key operation. However, certain settings (communication settings and setting information saved with the store/recall function) are not initialized.

To initialize the settings excluding the date/time setting (display ON/OFF is initialized) to their factory default conditions, turn ON the power while holding down the RESET key. Release the RESET key after a beep is heard.

### Auto Setup <For the setup procedure, see section 4.5>

This function automatically sets the voltage axis, time axis, trigger settings, and other settings to suit the input signal. This is useful when the characteristics of the input signal are unknown. However, the auto setup function may not work depending on the input signal.

### Preset <For the setup procedure, see section 5.7>

This function sets the V/div, input coupling, trigger level, and other settings to values that are suitable for CMOS and ECL signals (or arbitrary settings). You can also automatically set to the optimum values for the current probe 700937, 701930, 701931, and 701932 (sold separately).

### Printing Screen Images <For the setup procedure, see chapter 11>

Screen images can be printed on the built-in printer (option), USB printer, or network printer (when the Ethernet interface option is installed).

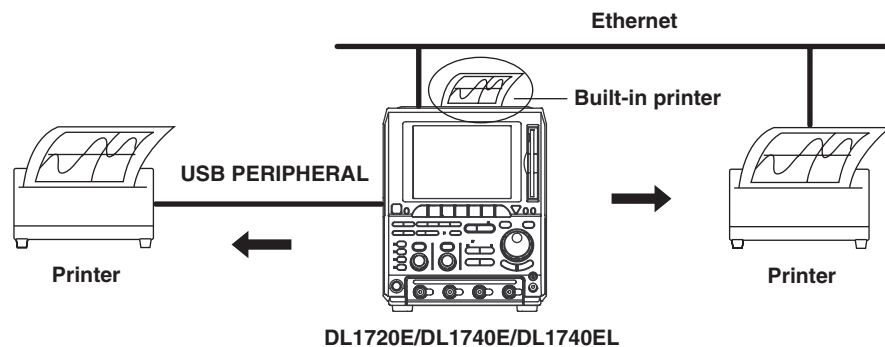

### Saving and Loading Data from the Storage Medium

<For the setup procedure, see chapter 12>

The DL1720E/DL1740E/DL1740EL allows various data to be stored to and loaded from the following storage media.

- Floppy disk or PC card
- External USB storage (MO disk drive, hard disk drive, flash memory)
- Network drive (when the Ethernet interface option is installed)

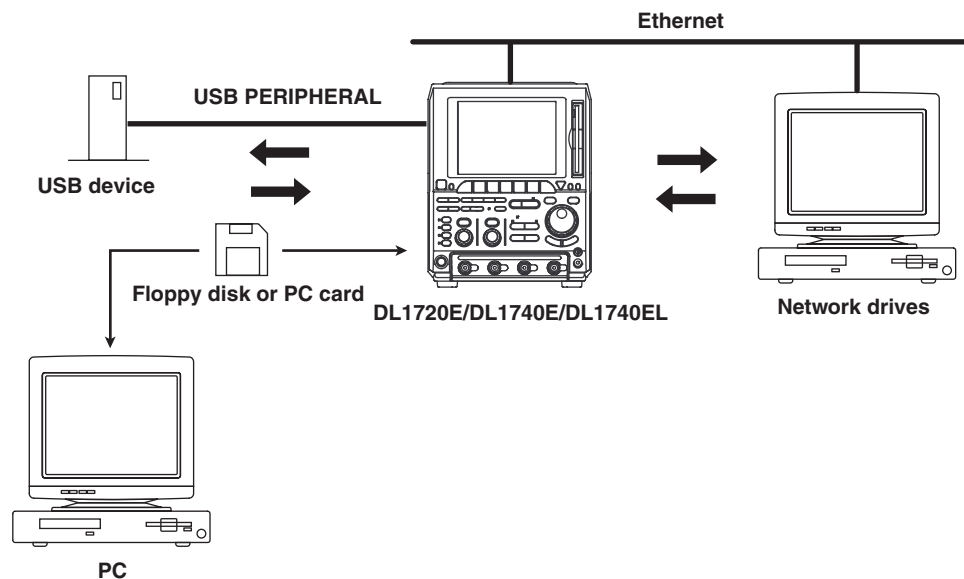

### Saving and Loading Setup Data, Waveform Data, and Snapshot Waveforms

<For the setup procedure, see sections 12.5 to 12.7>

The setup data, waveform data, and snapshot waveforms can be saved to or loaded from a selected storage medium.

### Saving Screen Image Data and Displaying the Thumbnails of the Stored Screen Image Data <For the setup procedure, see sections 12.9 and 12.10>

The screen image data can be stored to a selected storage medium. The data can be stored in TIFF, BMP, PostScript, PNG, and JPEG formats allowing the data to be pasted onto a document created with a DTP application. In addition, the thumbnails (reduced and simplified images) of the screen image data saved to the storage medium can be displayed on the instrument screen. This feature is useful for checking the contents of the stored screen image data.

## 2.8 Other Useful Functions

---

### **Saving Automated Measurement of Waveform Parameter Values <For the setup procedure, see section 12.8>**

You can save the automatically measured waveform parameter values to a storage medium.

### **Operating the instrument Using a Free Software Program**

The instrument can be controlled from a PC using Wirepuller, a free software program, when connected via the GP-IB, USB, or Ethernet interface. The software program can be downloaded from the following Web pages.

- English version      <http://www.yokogawa.com/tm/tm-softdownload.htm>
- Japanese version    <http://www.yokogawa.co.jp/Measurement/F-SOFT/>

## 3.1 Handling Precautions

### Safety Precautions

If you are using this instrument for the first time, make sure to thoroughly read the safety precautions given on page vi.

#### **Do Not Remove the Case**

Do not remove the instrument from the case. Some sections inside the instrument have high voltages and are extremely dangerous. For internal inspection or adjustment, contact your nearest YOKOGAWA representative.

#### **Unplug If Abnormal Behavior Occurs**

If you notice smoke or unusual odors coming from the instrument, immediately turn OFF the power and unplug the power cord. If such an irregularity occurs, contact your YOKOGAWA dealer.

#### **Do Not Damage the Power Cord**

Nothing should be placed on the power cord. The cord should be kept away from any heat sources. When unplugging the power cord from the outlet, never pull by the cord itself. Always hold and pull by the plug. If the power cord is damaged, contact your dealer for replacement. Refer to page iii for the part number when placing an order.

### General Handling Precautions

#### **Do Not Place Objects on Top of the Instrument**

Never place other instruments or objects containing water on top of the instrument, otherwise a breakdown may occur.

#### **Do Not Apply Shock to the Input Section**

Vibration or shock to the input connectors or probes may turn into electrical noise and enter the instrument via the signal lines.

#### **Do Not Damage the LCD**

Since the LCD screen is very vulnerable and can be easily scratched, do not allow any sharp objects near it. Also it should not be exposed to vibrations and shocks.

#### **Unplug during Extended Non-Use**

Unplug the power cord from the outlet.

### 3.1 Handling Precautions

---

#### **When Carrying the Instrument**

Remove the power cord and connecting cables. Always carry the instrument by the handle on the top (as shown below), or carry it with both hands.

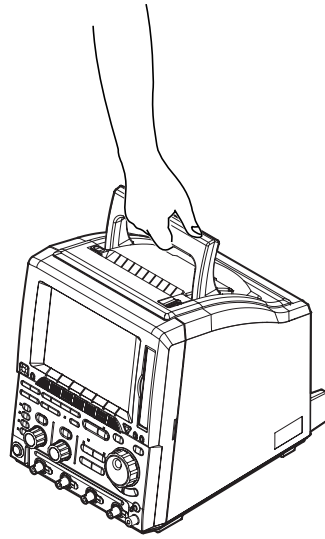

#### **Cleaning**

When cleaning the case or the operation panel, first remove the power cord from the AC outlet. Then, wipe with a dry, soft, clean cloth. Do not use volatile chemicals since this might cause discoloring and deformation.

## 3.2 Installing the Instrument

### Installation Conditions

Install the instrument in a place that meets the following conditions.

#### Flat, Even Surface

Install the instrument in the correct orientation on a stable, horizontal surface. The recording quality of the built-in printer (optional) may be hindered when the instrument is used in an unstable place.

#### Well-Ventilated Location

Ventilation holes are located on the bottom of the instrument. In addition, there are exhaust holes for the cooling fan on the rear panel. To prevent internal overheating, allow for enough space around the instrument (see the figure below) and do not block the ventilation and exhaust holes. If a printer comes with your DL1720E/DL1740E/DL1740EL, allow extra space for operation and do not place objects on top of the printer.

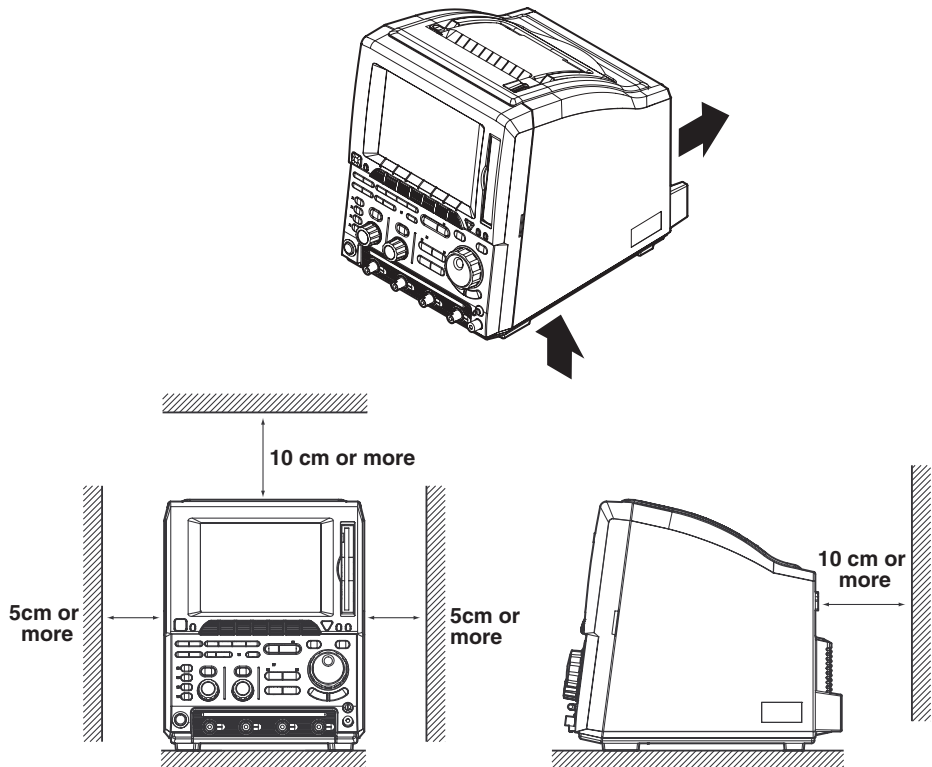

#### Ambient Temperature and Humidity

Ambient temperature: 5-40°C

Ambient humidity: 20 to 80% RH (when the printer is not used) } However, no condensation may be present  
35 to 80% RH (when the printer is used)

#### Note

- To ensure high measurement accuracy, operate the instrument in the  $23 \pm 2^\circ\text{C}$  temperature range and  $55 \pm 10\%$  RH.
- Condensation may occur if the instrument is moved to another place where the ambient temperature is higher, or if the temperature changes rapidly. In such cases, allow the instrument adjust to the new environment for at least an hour before using it.

## 3.2 Installing the Instrument

---

### Do not install the instrument in the following places.

- In direct sunlight or near heat sources.
- Where an excessive amount of soot, steam, dust, or corrosive gas is present.
- Near strong magnetic field sources.
- Near high voltage equipment or power lines.
- Where the level of mechanical vibration is high.
- On an unstable surface.

### Installation Position

Place the instrument in a horizontal position or inclined position using the stand (see the figure below). When using the stand, pull it forward until it locks. To retract it, push on the inside and set the stand back to its original position. When placing the instrument on its rear panel, use the rear panel stand.

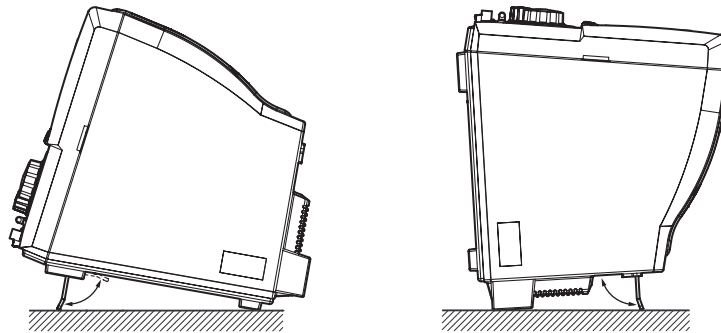

### Rubber Feet

If the instrument is installed in a tilted position as shown in the figure above, rubber stoppers can be attached to the feet to prevent the instrument from sliding. Four rubber feet are included in the package.

## 3.3 Connecting the Power Supply and Turning the Power Switch ON and OFF

### Before Connecting the Power

Make sure that you observe the following points before connecting the power. Failure to do so may cause electric shock or damage to the instrument.



### WARNING

- Before connecting the power cord, ensure that the source voltage matches the rated supply voltage of the instrument and that it is within the maximum rated voltage of the provided power cord.
- Connect the power cord after checking that the power switch of the instrument is turned OFF.
- To prevent the possibility of electric shock or fire, be sure to use the power cord for the instrument that was supplied by YOKOGAWA.
- Make sure to perform protective earth grounding to prevent electric shock. Connect the power cord to a three-prong power outlet with a protective earth terminal.
- Do not use an extension cord without protective earth ground. Otherwise, the protection function will be compromised.
- Use an AC outlet that complies with the power cord provided and securely connect the protective grounding. If such an AC outlet is unavailable and protective grounding cannot be furnished, do not use the instrument.

### Connecting the Power Cord

1. Check that the main power switch and power switch are turned OFF (see next page).
2. Connect the power cord plug to the power connector on the rear panel. Use the power cord that came with the package.
3. Connect the other end of the cord to an outlet that meets the conditions below. The AC outlet must be of a three-prong type with a protective earth ground terminal.  
The AC outlet must be of a three-prong type with a protective earth ground terminal.

Rated supply voltage	100 to 120 VAC/220 to 240 VAC
Permitted supply voltage range	90 to 132 VAC/198 to 264 VAC
Rated supply voltage frequency	50/60 Hz
Permitted supply voltage frequency range	48 to 63 Hz
Maximum power consumption (when using the printer)	200 VA

\* The instrument can use a 100-V or a 200-V system for the power supply. Check that the voltage supplied to the instrument is less than or equal to the maximum rated voltage of the provided power cord (see page ii) before using it.

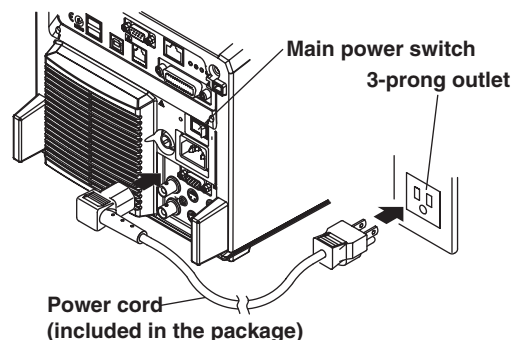



### 3.3 Connecting the Power Supply and Turning the Power Switch ON and OFF

---

#### Turning the Main Power Switch ON and OFF

The main power switch is located in the right center of the rear panel. Press the switch on the ON side to turn the power ON, and on the OFF side to turn the power OFF.

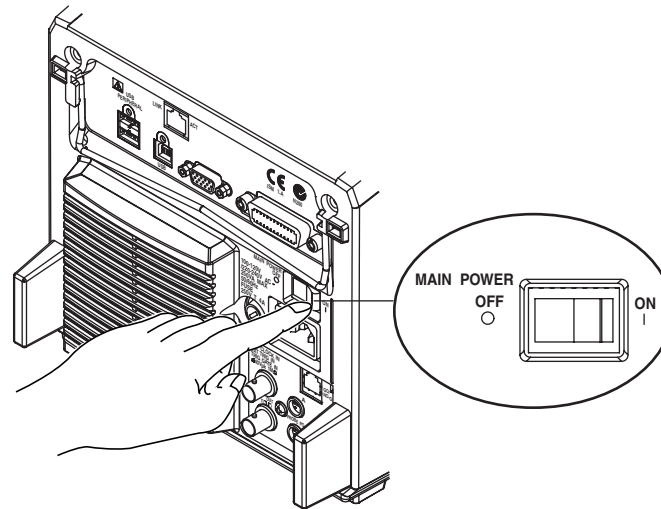

#### Turning the Power Switch ON and OFF

##### Items to Be Checked before Turning ON the Power

- That the instrument is properly installed: 3.2 Installing the Instrument
- That the power cord is properly connected: Connecting the Power Cord (page 3-5)

##### Turning the Power Switch ON and OFF

The power switch is located in the lower left corner of the front panel. The power switch is a push button. Press once to turn it "ON" and press again to turn it "OFF."

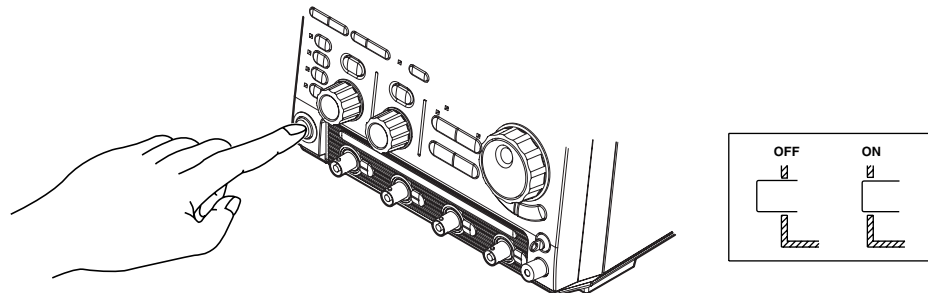

#### Power Up Operation

Self-test and calibration start automatically when the power switch is turned ON. If the check results are satisfactory, the normal waveform display screen will appear.

##### Note

---

- Allow at least ten seconds after turning OFF the main power switch and the power switch before turning it ON again.
- If self-test and calibration do not start when the power is turned ON, or if the normal waveform display screen does not appear, turn OFF the main power switch and the power switch and check the following points.
  - That the power cord is plugged in properly.
  - That the correct voltage is coming to the power outlet (see page 3-5).
  - That the power fuse has not blown -> See section 16.5.

If the instrument still fails to power up when the main power switch and the power switch is turned ON after checking these points, contact your nearest YOKOGAWA dealer.

---

#### Warm Up and Calibration

- To ensure accurate measurements, allow the instrument to warm up for at least thirty minutes after turning ON the power switch.
- After warm-up is complete, perform calibration (see section 4.6).

#### Power Down Operation

Current settings are stored immediately before the power is turned OFF or when the power cord is unplugged. Therefore, the next time the power is turned ON, the waveforms are displayed using the previous settings.

#### **Note**

---

A lithium battery is used to retain the setup parameters. When the lithium battery voltage falls below a certain level, a message is displayed on the screen (see section 16.2) when the power switch is turned ON. If this happens, you must quickly have the lithium battery replaced. The user cannot replace the battery. Contact your nearest YOKOGAWA dealer. For information regarding battery life, see section 16.6.

---

## 3.4 Connecting the Probe

### Signal Input Terminal

Connect the probe (or other input cable such as the BNC cable) to any of the input terminals (four terminals marked as CH1 to CH4 on the DL1740E or two terminals marked CH1 and CH2 on the DL1720E) at the bottom section of the front panel. The input impedance is  $1\text{ M}\Omega \pm 1.0\%$  and approximately  $20\text{ pF}$  or  $50\ \Omega \pm 1.0\%$ .



### CAUTION

- The maximum input voltage for  $1\text{-M}\Omega$  input is  $400\text{ V}$  (DC + AC<sub>peak</sub>) or  $282\text{ Vrms}$  when the frequency is  $1\text{ kHz}$  or less. Applying a voltage exceeding either of the two values can damage the input section. If the frequency is above  $1\text{ kHz}$ , damage may occur even when the voltage is below this value.
- The maximum input voltage for  $50\text{-}\Omega$  input is  $5\text{ Vrms}$  or  $10\text{ Vpeak}$ . Applying a voltage exceeding either of the two values can damage the input section.

#### DL1740E/DL1740EL

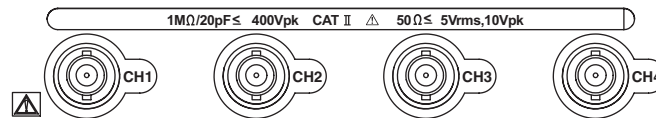

#### DL1720E

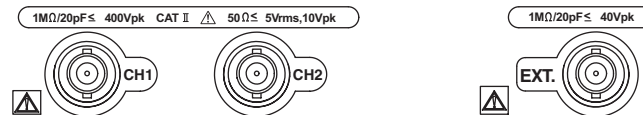

### Precautions to Be Taken When Connecting Cables

- When connecting a probe to the instrument for the first time, perform phase correction of the probe as described in section 3.5, "Compensating the Probe (Phase Correction)." Failure to do so will cause unstable gain across different frequencies, thereby preventing correct measurement. Perform the phase correction on each channel to which a probe is to be connected.
- Note that if the object being measured is directly connected to the instrument without using a probe, correct measurements may not be possible due to loading effects. Use caution when formatting a storage medium.

## Probes

**Specifications of the Probe (Model 700988) That Comes Standard (after Calibration)**

Item	Description		Requirement
	When attenuation is 10:1	When attenuation is 1:1	
Input resistance/ capacity	10 M $\Omega$ 2%, approx. 14 pF	1 M $\Omega$ 1.0%, approx. 150 pF	When used on the instrument
Attenuation	10:1 $\pm$ 3%	—	When used on the instrument
Frequency range	DC to 400 MHz	DC to 6 MHz	When used on the instrument
Rise time	Within 900 ps	Within 58 ns	When used on the instrument
Maximum input voltage	600 V (DC + AC <sub>peak</sub> ) or 424 V <sub>rms</sub> and frequency is 100 kHz or less	*	—
Connector type	BNC	BNC	—
Total length	1.5 m	1.5 m	—

\* When using the instrument with the attenuation set to 1:1, use the probe at a voltage less than or equal to the maximum input voltage of the instrument.

**Precautions to Be Taken When Using Probes Other Than Those Provided with the Instrument**

- When measuring a signal containing frequency components near 500 MHz, use a probe with a frequency range of 500 MHz or higher.
- Note that measured values cannot be displayed correctly when using a probe with an attenuation other than 1:1, 10:1, 100:1, and 1000:1.

**Setting the Probe Attenuation**

Follow the procedures given in section 5.5 and set the attenuation/current-to-voltage conversion ratio of the instrument according to the probe attenuation/current-to-voltage conversion ratio. Correct measured values can be displayed only if the setting is correct.

**When Using the FET Probe, Current Probe, or Differential Probe**

When using FET probes (700939), current probes (700937, 701930, 701931, or 701932), or differential probes (701920 or 701922) made by YOKOGAWA, use the probe power supply on the rear panel of the instrument.

**CAUTION**

Do not use the probe power supply terminals on the rear panel of the instrument for purposes other than supplying power to the FET probe (700939), current probes (700937, 701930, 701931, or 701932), or differential probes (701920, or 701922). Doing so may damage the instrument or the device connected to them.

### 3.4 Connecting the Probe

#### When Using the FET Probe, Current Probe, or Differential Probe

When connecting FET probes (700939), current probes (700937, 701930, 701931, or 701932), or differential probes (701920 or 701922) to the probe power supply terminal on the rear panel, make sure that the current does not exceed the range shown below. Otherwise, the instrument operation may become unstable due to the activation of the excessive current protection circuit of the power supply.

DL1740E/DL1740EL

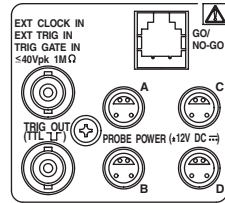

DL1720E

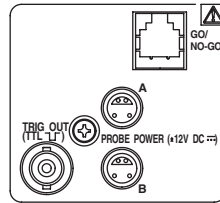

Given terminals A through D  
 (Consumption current of A) +  
 (consumption current of B)  $\leq$  400 mA  
 (Consumption current of C) +  
 (consumption current of D)  $\leq$  400 mA  
 (Total consumption current of  
 A through D)  $\leq$  600 mA

When using the current probe (700937, 701930, 701931, or 701932), the number of probes that can be used is limited by the current generated by the device under measurement (current measured by the current probe). The characteristics of the measured current versus the current consumption of an active probe that can be connected to the instrument are shown below.

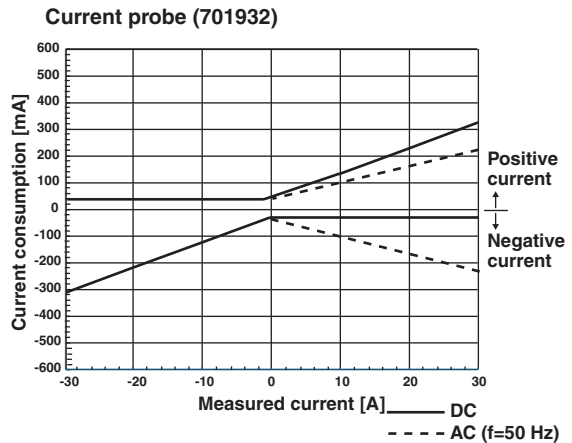
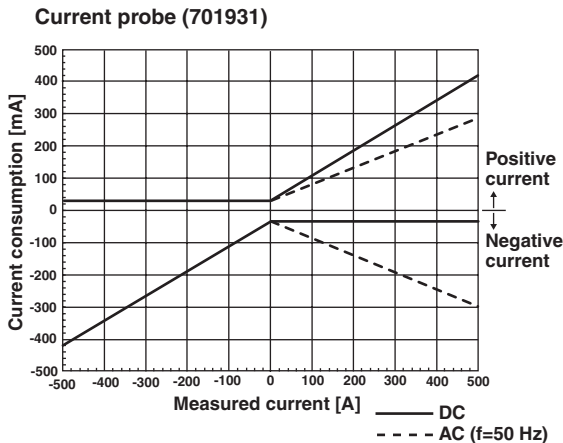
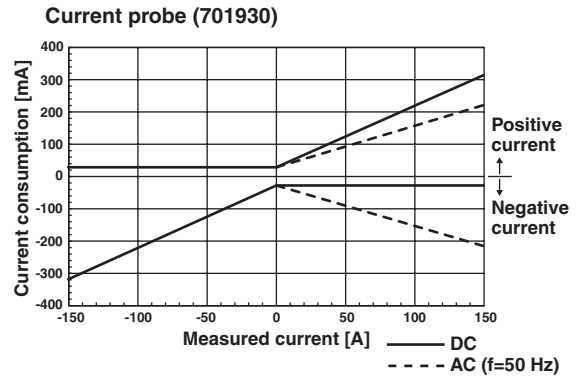
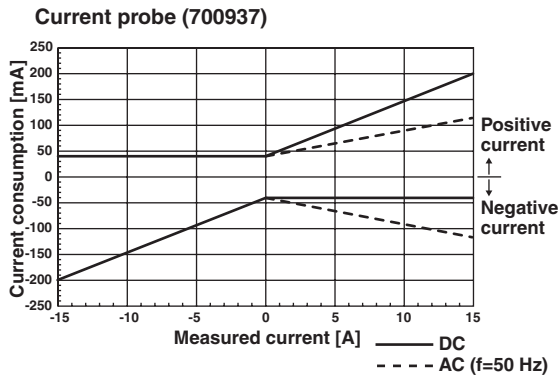

Calculate the consumption current of the FET probe (700939) and the differential probe (701920 or 701921) at 125 mA maximum for both positive and negative polarities.

## 3.5 Compensating the Probe (Phase Correction)



### CAUTION

Do not apply external voltage to the probe compensation signal output terminal. Doing so can damage the internal circuits.

#### Procedure

1. Turn ON the power switch.
2. Connect the probe to the input terminal to which the signal is to be applied.
3. Connect the tip of the probe to the probe compensation signal output terminal and the ground wire to the functional ground terminal.
4. Perform auto setup according to the procedures given in section 4.5.
5. Insert a flat-head screwdriver to the phase correction hole and turn the variable capacitor to make the displayed waveform a correct rectangular wave.

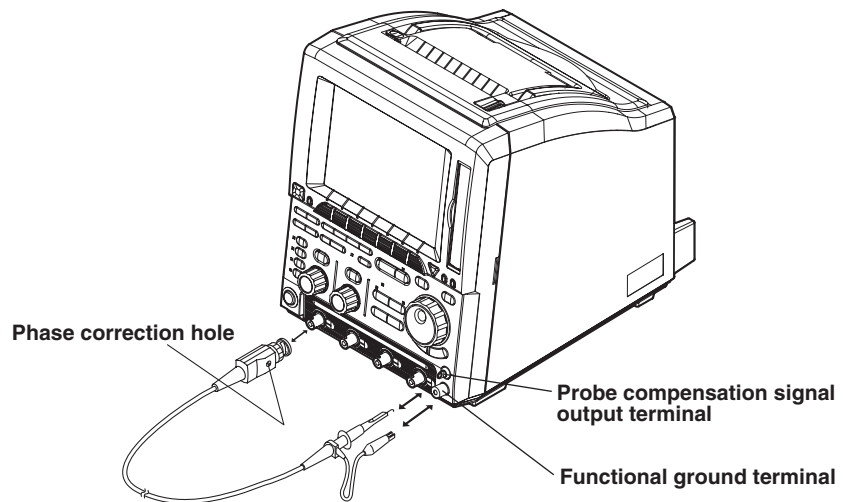

#### Explanation

##### Necessity of Phase Correction of the Probe

When using the oscilloscope with a probe, the probe phase must be corrected by adjusting the variable capacitor inside the probe so that the gain is constant relative to the frequency. Measurements will not be accurate unless this adjustment is made, therefore you should make sure to perform this phase correction when using the probe for the first time.

The input capacitance differs depending on the oscilloscope. It can also vary slightly from channel to channel, even on the same oscilloscope. Even if the phase has been previously corrected, you must perform the correction again if you move the probe to a new oscilloscope or a different channel.

##### Probe Compensation Signal

The probe compensation signal output terminal outputs the following rectangular wave signal.

Frequency: Approximately 1 kHz

Amplitude: Approximately 1 V

### 3.5 Compensating the Probe (Phase Correction)

---

#### Differences in the Waveform due to the Phase Correction of the Probe

Correct waveform

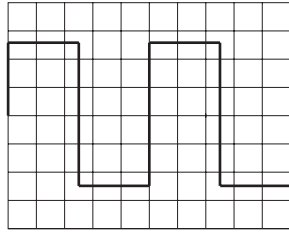

Over compensated  
(the gain in the high  
frequency region is up)

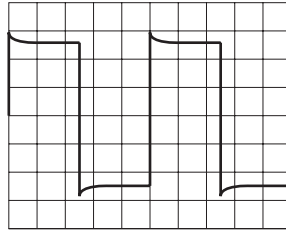

Under compensated  
(the gain in the high  
frequency region is low)

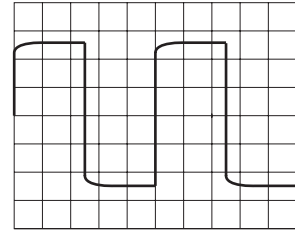

## 3.6 Setting the Date and Time

### Procedure

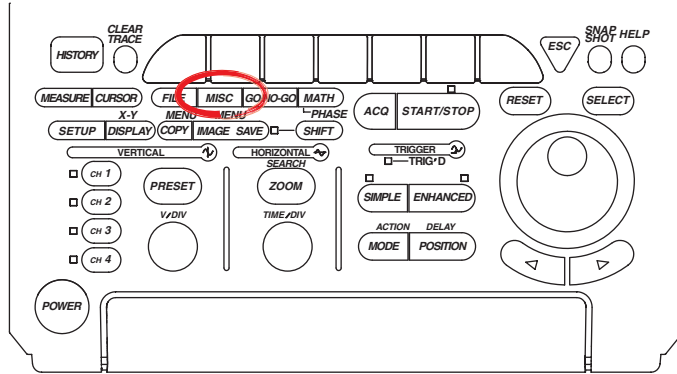

- To exit the menu during operation, press **ESC** located above the soft keys.
- In the procedural explanation below, the term **jog shuttle & SELECT** refers to the operation of selecting/setting items and entering values using the **jog shuttle** and **SELECT** and **RESET** keys. For details on this operation, see sections 4.1 and 4.2.
- For a description of the operation using a USB keyboard or a USB mouse, see section 4.3.

### Displaying the Date/Time Setup Dialog Box

1. Press the **MISC** key.
2. Press the **System Config** soft key. The System Cnfg menu appears.

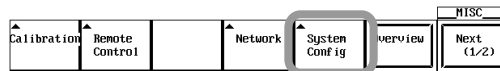

3. Press the **Date/Time** soft key. The Date/Time setup dialog box appears.



### Turning the Date/Time Display ON and OFF

4. Use **jog shuttle & SELECT** to set Display to ON or OFF.

### Selecting the Date/Time Setting Method

5. Use **jog shuttle & SELECT** to set the Type to Manual or SNTP.

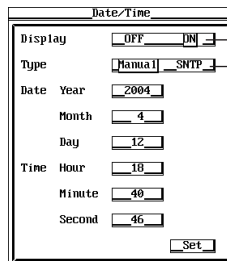

- Turning the Date/Time display ON and OFF
- Selecting the Manual or SNTP method for the Date/Time display settings.



### 3.6 Setting the Date and Time

- **When Selecting Manual (Manually Enter the Date and Time)**

6. Use jog shuttle & SELECT to set the Year.
7. Likewise, set the Month, Day, Hour, Minute, and Second.
8. Turn the jog shuttle to move the cursor to Set and press **SELECT**. Press SELECT to confirm the Date/Time setting.

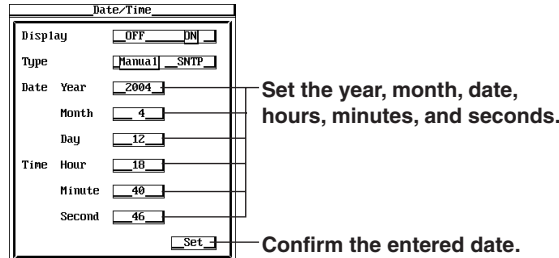

- **When Selecting SNTP (Use the NTP Server or SNTP Server to Set the Date/Time)**

6. Use jog shuttle & SELECT to set the Time Hour of Time Difference from GMT in the range of -12 to 13.
7. Likewise, set the Minute of Time Difference From GMT in the range of 0 to 59.
8. Turn the jog shuttle to move the cursor to Set and press SELECT.

If the instrument is connected to the network and the NTP server or SNTP server is already specified, pressing SELECT will make the instrument retrieve the date/time information from the NTP server or SNTP server and automatically set the current date/time by calculating the specified time difference from GMT. If the time information cannot be retrieved such as due to an incorrect assignment of the SNTP server, an error message is displayed.

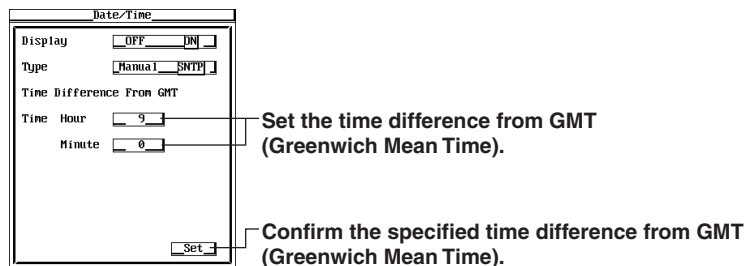

### Explanation

#### Date (Year/Month/Date)

Set the year, month and day. The selectable range of years is 1999 to 2079.

#### Time (Hour/Minute/Second)

Set the time using a 24-hour clock.

#### Automatically Setting the Date/Time Using the NTP Server or SNTP Server

On models with the Ethernet interface installed, the instrument can behave as an SNTP client to retrieve data/time information from a specified NTP server or SNTP server on the Internet and automatically set the date/time. After retrieving the current date/time information, the date/time information is retrieved every time the power to the instrument is turned ON.

For the procedure of specifying the SNTP server, see section 13.8, "Setting the Time Difference from GMT (Greenwich Mean Time)."

The time difference from GMT that you specify here is synchronized to the Time difference From GMT setting in section 13.8, "Setting the Time Difference from GMT."

#### Note

- The date/time setting is backed up with the lithium battery when the power is turned OFF.
- Leap years are supported.

# 4.1 Operations and Functions of Keys and the Jog Shuttle

## Basic Key Operations

### Displaying the Setup Menu of the Panel Keys

1. Press the desired panel operation key. The setup menu appears.
2. Press the soft key corresponding to the desired setup menu item.

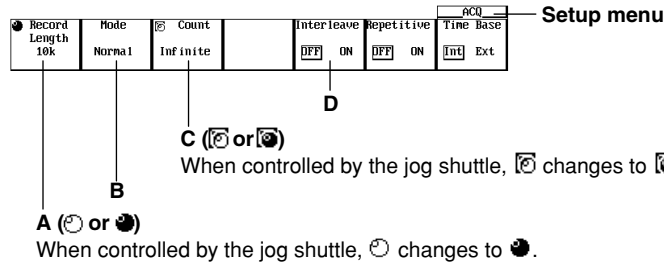

- A**: Press the corresponding soft key to set the item under jog shuttle control. Turn the jog shuttle to change the setting. Press RESET to set the item back to the initial setting.
- B**: Press the corresponding soft key to display the selection menu. Press the soft key corresponding to a selection to make the selection.
- C**: Press the corresponding soft key to set the item under jog shuttle control. Turn the jog shuttle to set the value. Press the arrow keys to change the selected digit. You can directly enter the value from a USB keyboard.
- D**: Press the corresponding soft key to switch the selected item.

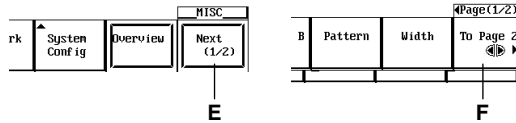

- E**: Appears when there are two pages of the setup menu. Press the corresponding soft key to display page 2/2 (2 of 2) of the setup menu. The name changes to "Back (2/2)." To return to page 1/2 (1 of 2), press the corresponding soft key again.
- F**: Appears when the soft key selections span over multiple pages. Press the corresponding soft key or the right arrow key to display the next page of the menu. For example, if there are two pages, the pages advance in the following order: page 1, page 2, page 1, page 2, and so on.

### Displaying the Setup Menu Marked in Purple above or below the Panel Keys

In the explanations in this manual, SHIFT + panel key name (purple text) refers to the following operation.

1. Press the **SHIFT** key. The green indicator above SHIFT illuminates to indicate the shifted state. The setup menu marked in purple above or below the panel keys can be selected.
2. Press the panel key corresponding to the setup menu you wish to display.

## 4.1 Operations and Functions of Keys and the Jog Shuttle

### Operations on the Setup Dialog Box

In the explanations in this manual, **jog shuttle & SELECT** refers to the following operation.

1. Open the setup dialog box using basic key operations or other means.
2. Turn the jog shuttle to move the cursor to the item you wish to set.
3. Press **SELECT**.

The behavior that results when you press SELECT varies depending on the item as described below.

- \* When selecting a medium, directory, or file name on the File List window, you operate the jog shuttle to move the cursor and select using the SELECT key. This operation is also referred to as jog shuttle & SELECT.

### Setup Dialog Box

Turn the jog shuttle to move the cursor to the item you wish to set.

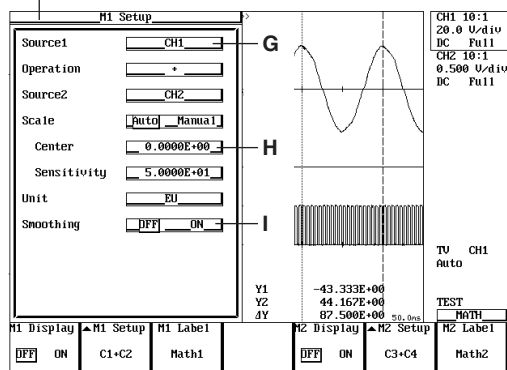

#### When Source1 is selected (G)

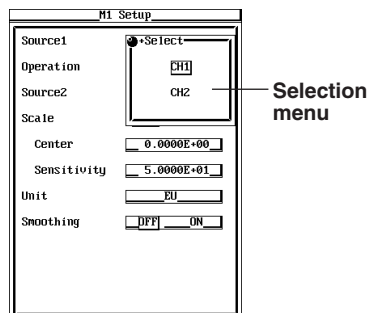

#### When Center is selected (H)

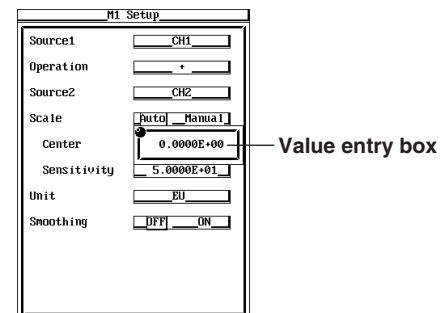

**G:** Press SELECT to display the selection menu.

Turn the jog shuttle to move the cursor to the item you wish to set.  
Press SELECT to confirm the selection.

**H:** Press the SELECT key to display the value entry box.

Turn the jog shuttle to set the value. Press the arrow keys to change the selected digit.  
You can directly enter the value from a USB keyboard.  
Press RESET to set the item back to the initial setting.

**I:** Press the SELECT key to switch the selected item.

### Clearing the Setup Menu and Setup Dialog Box Displays

Press ESC. The setup menu or the dialog box shown on top is cleared from the screen.

#### Note

- In the procedural explanations in this manual, the operation of clearing the setup menu or setup dialog box may not be given.
- If the setup menu is cleared when the automated measurement values of waveform parameters or cursor measurement values are displayed in the waveform display area, these measured values are displayed at the display position of the setup menu.

## 4.2 Entering Values and Strings

### Entering Values

#### Entering Values Directly Using the Dedicated Knobs

The dedicated knobs indicated below can be turned to directly enter values.

- V/DIV knob
- TIME/DIV knob

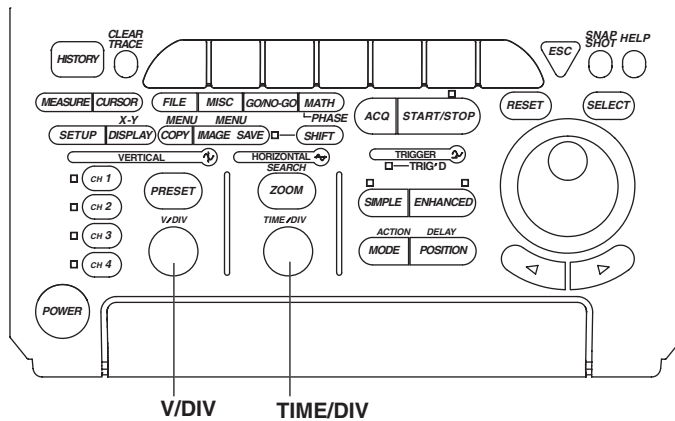

#### Entering Values Using the Jog Shuttle

After selecting the setup item using the soft key, use the jog shuttle to change the value (in the explanations in this manual, this operation may be indicated as **jog shuttle & SELECT**). The outer shuttle ring can be used to step through the values in large increments. On some items, the arrow keys below the jog shuttle can be used to change the selected digit.

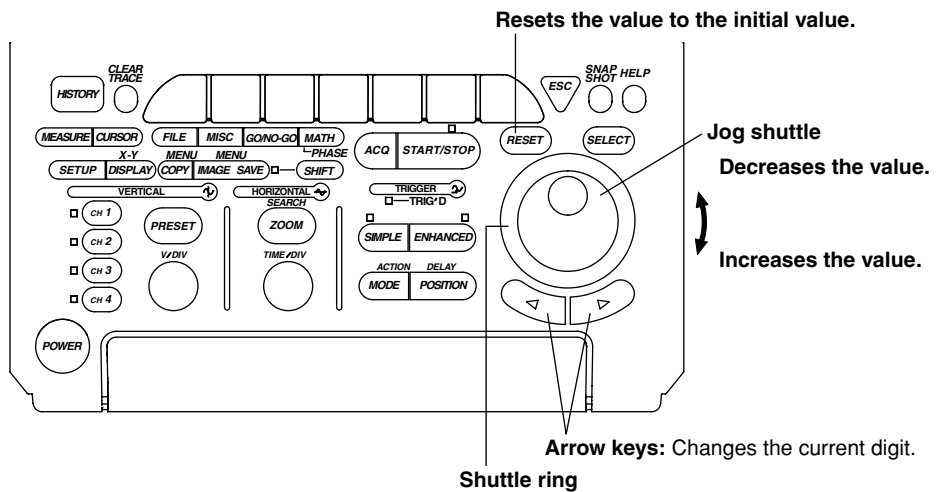

Display	Position	Coupling	Probe	Offset	Bandwidth	CH1
OFF	DN	0.00div	DC1Hz	10:1	0.000kHz	Full

Mark indicating that the jog shuttle can be used to set the value

#### Note

The items that can be changed using the jog shuttle are reset to their default values when the RESET key is pressed.

### Entering Strings

The keyboard displayed on the screen is used to enter character strings such as file names and comments. The jog shuttle, SELECT key, and arrow keys are used to operate the keyboard to enter the character strings.

#### Operating the Keyboard

1. Turn the jog shuttle to move the cursor to the character to be entered. You can also press the soft keys corresponding to ▲ and ▼ to move the cursor vertically.
2. Press the **SELECT** key to enter the character.  
If a character string has already been entered, move the cursor to the position in the string at which you want to enter a character.
3. Repeat steps 1 and 2 to enter all the characters in the string.
4. Selecting ENT on the keyboard and pressing **SELECT** confirms the string and the keyboard disappears. You can also press the ENT soft key to confirm the string and clear the keyboard. At the same time, the confirmed string is temporarily stored.  
If you wish to clear the entire string that you have entered, press **RESET** before confirming the string.

**Keyboard for entering capital letters:** toggle using the CAPS soft key.

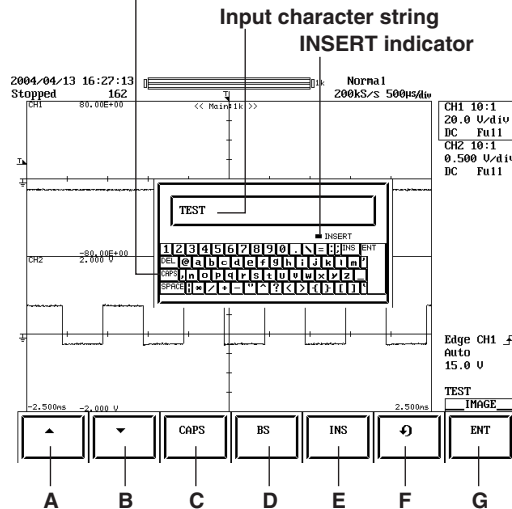

- A: Moves the cursor upward.
- B: Moves the cursor downward.
- C: Switches between uppercase and lowercase and a portion of the symbols.
- D: Deletes the character before the entry position.
- E: Switches the insert/overwrite mode. When in insert mode, the INSERT indicator on the keyboard illuminates in red.
- F: Recalls the temporary stored string. See "Recall" described later.
- G: Confirms the displayed characters.

**Keyboard for entering lowercase letters:** toggle using the CAPS soft key.

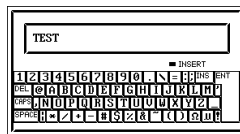

#### Temporary Storage of Character Strings

Up to eight confirmed strings are automatically stored. When the number of confirmed strings exceeds 8, the strings are deleted in order starting from the oldest string. For items with a string set as a default value such as channel labels, up to eight strings including the initial string can be temporarily stored. Even when the number of confirmed string exceeds 8, the default string is not cleared. The oldest of the seven confirmed strings excluding the default string is deleted.

**Recalling**

(Note that the unconfirmed string that is displayed in the entry box of the keyboard is overwritten when a string is recalled using the procedure in step 1 below.)

1. Every time the  $\text{☺}$  soft key is pressed, strings that are temporarily stored appear in order from the newest string in the input box of the keyboard. When the eight strings that are temporarily stored are displayed, the newest string is displayed again.
2. You can also edit the recalled string by performing steps 1 to 4 of “Entering Strings” described above. When the string is confirmed, it is temporarily stored as a new string.

**Keys Other Than the Character Keys**

DEL	Deletes the character at the cursor.
INS	Switches the insert/overwrite mode. When in insert mode, the INSERT indicator on the keyboard illuminates in red.
SPACE	Enters a space.
ENT	Confirms the displayed characters.
CAPS	Switches between uppercase and lowercase. Also switches a portion of the characters assigned to the keyboard.

**Number of Characters and Types That Can Be Used in the Settings**

Number of Characters	Characters That Can Be Used	
Date/Time	Specified number	0 to 9(/ :)
File name	1 to 14 characters	0 to 9, A to Z, %, _, (, ), -
Comments for screen images	0 to 20 characters	All characters (including spaces)
Comments for files	0 to 25 characters	All characters (including spaces)
Comments for e-mails	0 to 30 characters	All ASCII characters on the keyboard (including spaces)
E-mail address	0 to forty characters	All ASCII characters on the keyboard (including spaces)
User name and login name	0 to 15 characters	All ASCII characters on the keyboard (including spaces)
Password	0 to 15 characters	All ASCII characters on the keyboard (including spaces)

**Note**

- Multiple @ characters cannot be entered consecutively.
- File names are not case-sensitive. Comments are case-sensitive. In addition, the following file names cannot be used due to limitations of MS-DOS.  
AAUX, CON, PRN, NUL, CLOCK, COM1 to COM9, and LPT1 to LPT9

## 4.3 Operating the instrument Using a USB Keyboard or a USB Mouse

### Operations Using a USB Keyboard

You can connect a USB keyboard for entering file names, comments, and other information. In addition, the functions of each key on the front panel of the instrument are assigned to the keys on the keyboard (see appendix 5). Thus, the keyboard can be used to carry out operations that are the same as the key operations on the instrument.

#### Keyboards That Can Be Used

Keyboards that can be used depend on the USB keyboard language that you selected in section 15.2 (English or Japanese). The following keyboards that conform to USB Human Interface Devices (HID) Class Version 1.1 can be used.

- When the USB keyboard language is English: 104 keyboard and 89 keyboard
- When the USB keyboard language is Japanese: 109 keyboard and 89 keyboard

The default setting is the language specified by the message language selection (see section 15.1). To use a Japanese keyboard, change the USB keyboard language according to the procedures given in section 15.2.

#### Note

- Connect only the keyboards that are allowed.
- The operation of USB keyboards connected to a USB hub or those that have mouse connectors is not guaranteed.
- For USB keyboards that have been tested for compatibility, contact your nearest YOKOGAWA dealer.

#### USB PERIPHERAL Connector

Connect the USB keyboard to the USB PERIPHERAL connector on the rear panel. There are two USB PERIPHERAL connectors (ports).

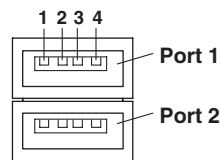

Pin No.	Signal Name
1	VBUS: +5 V
2	D-: -Data
3	D+: +Data
4	GND: Ground

#### Connection Procedure

When connecting a USB keyboard, directly connect the keyboard to the instrument using a USB cable as shown below. You can connect the USB cable regardless of whether the power to the instrument is ON or OFF (supports hot-plugging). Connect the type A connector of the USB cable to the instrument; connect the type B connector to the keyboard. When the power switch is ON, the keyboard is detected and enabled approximately six seconds after it is connected.

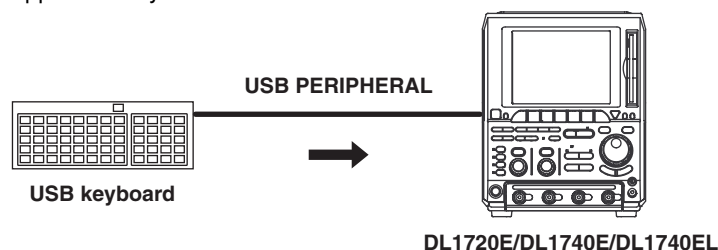

**Note**

- Connect the keyboard directly without going through a USB hub.
- Do not connect multiple keyboards. Only one keyboard, one mouse, and one printer can be connected.
- Holding down a key on the keyboard does not enter the character or value repeatedly.
- Do not connect and disconnect multiple USB devices successively. Allow at least ten seconds between the connection and disconnection of a USB device and the connection and disconnection of the next USB device.
- Do not disconnect the USB cable after the power is turned ON until key operation becomes possible (approximately 20 to 30 s).

**Confirming the Type of Keyboard That Is Connected**

To determine the type of keyboard that is connected to the instrument, follow the procedure given in section 15.2.

**Entering File Names, Comments, and Other Items**

When a keyboard is displayed on the screen, you can enter the file name, comment, and other items using a USB keyboard. The character that is entered through each key of the USB keyboard varies depending on the keyboard type. For details, see appendix 5.

**Executing Functions Corresponding to the Front Panel Keys of the Instrument**

The functions corresponding to the front panel keys of the instrument are assigned to the keys on the USB keyboard. By pressing the keys on the keyboard, you can operate the instrument in a similar fashion. The assignment of functions varies depending on the keyboard type. For details, see appendix 5.

**Entering Values from a USB Keyboard**

You can enter values from a USB keyboard for items with the  or  icon.

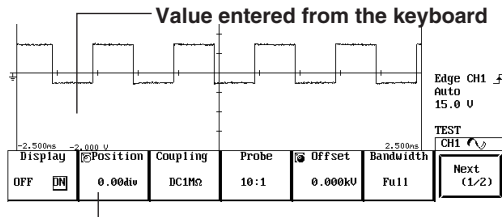

Press the corresponding soft key to enter a numerical value using the USB keyboard  
 Press the Enter key to enter the value and display it on screen.

**Entering Values with Prefix Units**

If a prefix unit is shown as in “Offset” in the above example (“k” of “kV”), you can enter not only the value but also the prefix unit from the USB keyboard. The items for which you can enter prefix units are voltage (V), time (seconds: s), and current (A).

• **Entry Example**

- Entering 1 for the Offset in the example above is equivalent to entering 1 V, and the screen displays 1000 mV or 1.0 V.
- Entering 1, 0, m for the Offset is equivalent to entering 10 mV. The screen displays 10 mV, 0.01 V, and so on. In this case, the setting takes effect from the point at which the prefix units are entered, so you do not have to press the Enter key.

Input Key	Prefix Unit
K or k	10 <sup>3</sup> (kilo)
m	10 <sup>-3</sup> (mili)
U or u	10 <sup>-6</sup> (micro)
N or n	10 <sup>-9</sup> (nano)
P or p	10 <sup>-12</sup> (pico)



## 4.3 Operating the instrument Using a USB Keyboard or a USB Mouse

---

### Operations Using a USB Mouse

You can use a USB mouse to operate the instrument as you would using the front panel keys. In addition, you can point to a desired item on a menu and click the item. This is analogous to pressing a soft key corresponding to a menu and pressing the SELECT key.

#### USB PERIPHERAL Connector

The USB mouse is connected to the USB PERIPHERAL connector on the rear panel of the instrument. For details on the USB PERIPHERAL connector, see page 4-6.

#### Compatible USB Mouse

A USB wheel mouse conforming to USB HID Class Version 1.1 can be used.

#### Note

---

- For USB mouse devices that have been tested for compatibility, contact your nearest YOKOGAWA dealer.
  - Some items cannot be specified when using a mouse without a wheel.
- 

#### Connection Procedure

When connecting a USB mouse, directly connect the mouse to the USB PERIPHERAL connector on the rear panel (see page 4-6). You can connect/disconnect the USB mouse connector regardless of the power ON/OFF state of the instrument (supports hot-plugging). When the power switch is turned ON, the mouse is detected approximately six seconds after it is connected, and a pointer (  ) is displayed.

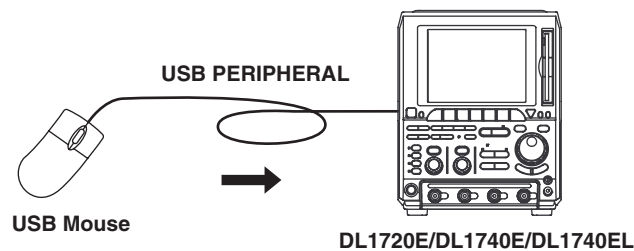

#### Note

---

There are two USB PERIPHERAL connectors on the instrument. However, do not connect mouse devices to both connectors at the same time.

---

#### Confirming the Type of USB Mouse That Is Connected

The procedure for confirming the type of USB mouse that is connected to the instrument is the same as the procedure for confirming the type of USB keyboard. See section 15.2.

**USB Mouse Operation**

• **Operations Similar to the Front Panel Keys (Top Menu)**

**Displaying the Top Menu**

Right-click on the screen. The front panel key names on the instrument are displayed as the top menu.

**Selecting Items on the Top Menu**

Click the item you wish to select. The setup menu corresponding to the selected item is displayed on the right side of the screen. The top menu is cleared from the screen. Pointing to items with a sub menu (items with a > mark displayed to their right) displays the sub menu. As with the top menu, click the item you wish to select and left-click the item.

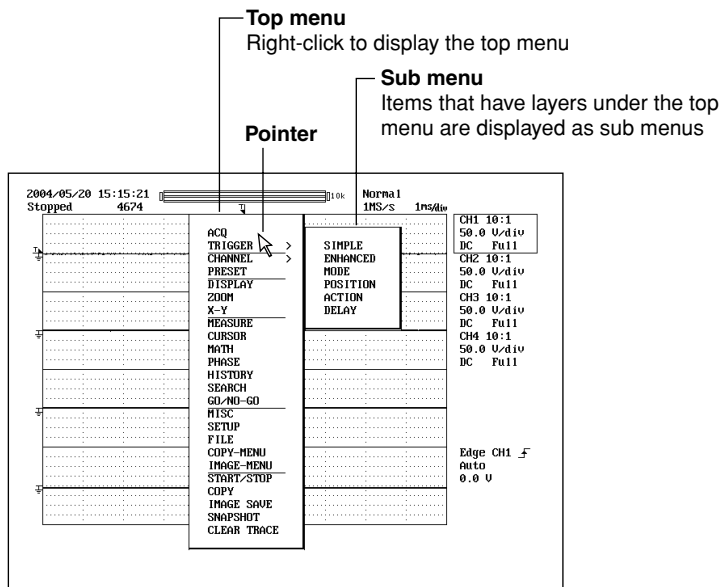

The setup menu appears.

Format	Interpol	Graticule	Scale Value	Trace Label	Accumulate	DISPLAY
Dual	Sine		OFF <b>DN</b>	OFF <b>DN</b>	OFF	Next (1/2)

**Note**

- The following key names do not appear on the top menu. ESC, RESET, SELECT, HELP, and arrow keys
- The top menu also displays characters that are marked in purple above the panel keys.
- The TRIGGER sub menu contains the following TRIGGER group panel key names. MODE, SIMPLE/ENHANCED, POSITION, ACTION, and DELAY
- To display the COPY menu or the IMAGE SAVE menu, select COPY-MENU or IMAGE-MENU, respectively. To execute the COPY or IMAGE SAVE operation, select COPY or IMAGE SAVE, respectively.

### 4.3 Operating the instrument Using a USB Keyboard or a USB Mouse

- **Setup Menu Operation (Similar to the Soft Key Operation)**

#### Selecting an Item on the Setup Menu

Left-click the item you wish to select on the setup menu.

If another menu appears when you select an item, move the pointer to the new menu displaying the item you wish to select and left-click the item.

If an item such as ON or OFF appears when you select an item, move the pointer to the new frame and left-click within the frame to switch the selected item.

For menus in which items are selected using jog shuttle & SELECT (see page 4-3), left-click the desired item. Left-click again to confirm the new setting and close the selection dialog box. You can turn the mouse wheel to select scrollable items.

**Left-click within the frame to show the selection menu.**

**Point to the item you wish to select and left-click the item to confirm the selection.**

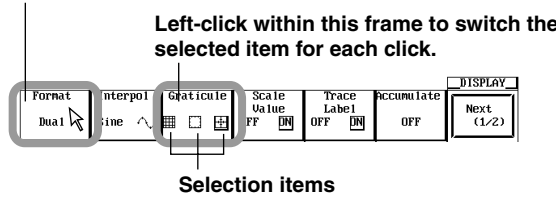

#### Clearing the Menu

Left-click an area outside the menu.

- **Setting Values**

For menu items with a or icon, the numeric value can be entered as follows:

- To select a menu item with a or icon, left-click the center of the menu item. If there are two setup items in a single menu item, you can repetitively left-click to select either item.
- Turn the mouse wheel downward to increase the value.
- Turn the mouse wheel upward to decrease the value.
- To change the selected digit, move the pointer to the left or right of the value. The pointer changes to or . Left-click to the left or right of the value. If you point to the left of the value and left-click, the current digit moves to the left; if you point to the right of the value and left-click, the current digit moves to the right. The current digit moves one digit at a time for each left-click.
- To restore a value's default setting, right-click on the value's menu item.

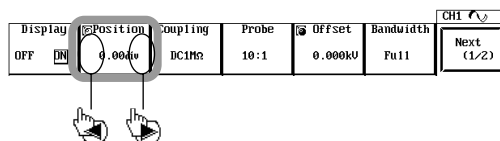

**Moving the pointer in this menu causes the pointer shape to change.**

**Left-click to move the current digit.**

**Right-click on the menu parameter to reset the value to default.**

- **Selecting Toggle Box Items on the Dialog Box**

Left-click the item you wish to select. The item is selected. Click the selected item again to deselect it.

To close the dialog box, point to an area outside the dialog box and left-click.

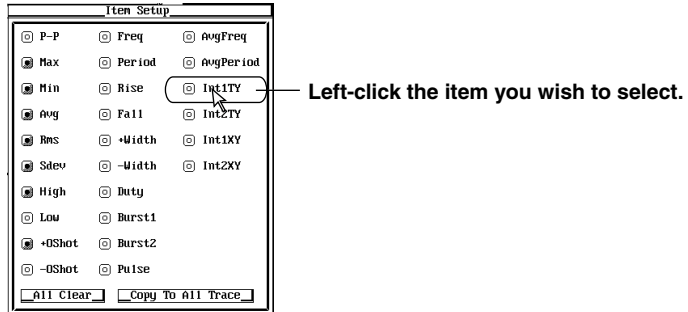

**Note**

To close an error dialog box, left- or right-click or turn the mouse wheel without moving the mouse.

- **Selecting a File, Directory, or Disk Drive on the File List Window**

Left-click a file, directory, or disk drive name to select it.

Turn the mouse wheel to scroll through the file list.

To cancel the selection, point to an area outside the file list window and left-click. The selection is cancelled, and the file list window closes.

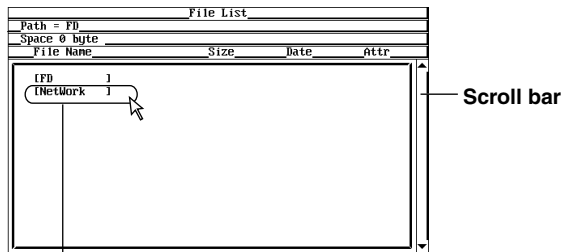

Move the pointer to the file, directory, or storage medium you wish to select and left-click.

### 4.3 Operating the instrument Using a USB Keyboard or a USB Mouse

- **Setting the V/div and T/div**

#### Setting the V/div

When the waveform of a channel measuring a voltage is displayed, point near the V/div value displayed at the bottom of the screen. The pointer changes to .

Left-click on the V/div value of the channel you wish to set. The target V/div value is enclosed in a box and selected.

Turning the mouse wheel upward increases the V/div value; turning it downward decreases the V/div value.

#### Setting the T/div

Point near the T/div value displayed at the upper right corner of the screen. The pointer changes to . Turning the mouse wheel upward increases the T/div value; turning it downward decreases the T/div value.

**Moving the pointer to the position indicated below changes the pointer display (  ). You can change the V/div or T/div setting by turning the wheel in this condition.**

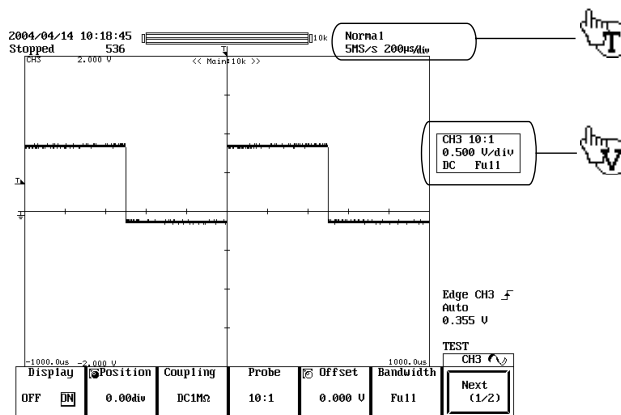

## 4.4 Initializing Settings

### Procedure

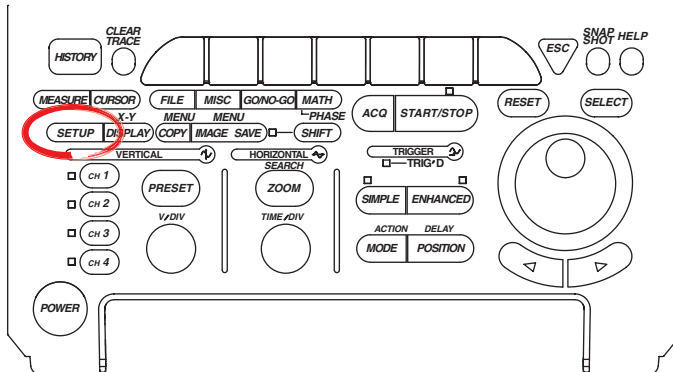

- To exit the menu during operation, press **ESC** located above the soft keys.
- For a description of the operation using a USB keyboard or a USB mouse, see section 4.3.

### Executing Initialization

1. Press **SETUP**.
2. Press the **Initialize** soft key. Initialization executes.

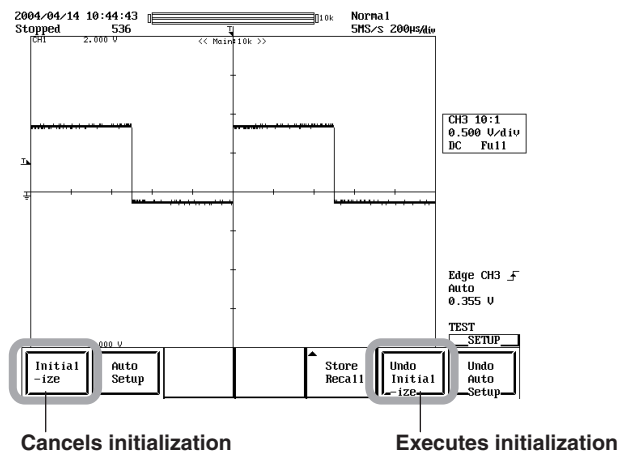

### Canceling Initialization

3. Press the **Undo Initialize** soft key. The settings return to the conditions that existed immediately before initialization.

### Note

When you turn OFF the power switch, the settings that existed immediately before initialization are cleared. Therefore, the "Undo Initialize" operation is not possible in this case.

### ***Explanation***

Values set using keys can be restored to their original conditions upon shipment from the factory. This is useful when you wish to clear previous settings or start measurement from scratch.

#### **Initialization**

Initialization refers to the act of restoring the factory default conditions.

For a description of the conditions of the instrument upon shipment from the factory, see appendix 4, "List of Default Settings."

#### **Settings That Cannot Be Initialized**

- Date/Time settings
- Communication related settings
- Setup data that has been stored using the store/recall function
- English/Japanese language setting
- USB keyboard language

#### **Canceling Initialization**

If you initialize the settings by mistake, you can press the Undo Initialize soft key to return to the conditions that existed before the initialization.

#### **Initializing All the Settings**

When the power is turned ON while holding down the RESET key, all settings excluding the date/time setting (display ON/OFF is initialized) are initialized to the factory defaults. Setup data that has been stored using the store/recall function is also initialized. If you initialize the instrument in this fashion, the settings cannot be set back to their original condition.

## 4.5 Executing Auto Setup

### Procedure

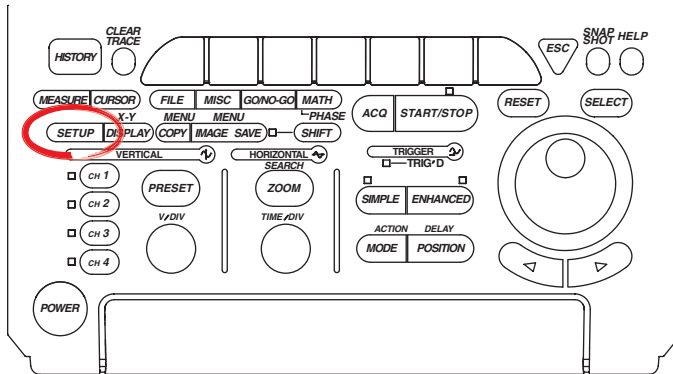

- To exit the menu during operation, press **ESC** located above the soft keys.
- For a description of the operation using a USB keyboard or a USB mouse, see section 4.3.

### Executing Auto Setup

- Press **SETUP**.
- Press the **Auto Setup** soft key. Auto setup executes. When auto setup is executed, waveform acquisition starts automatically.

#### Before Auto setup

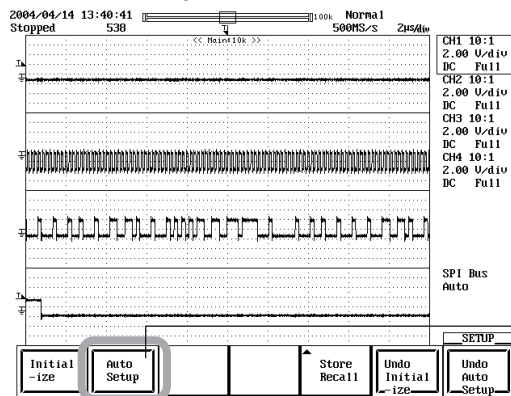

Executes auto setup

#### After auto setup

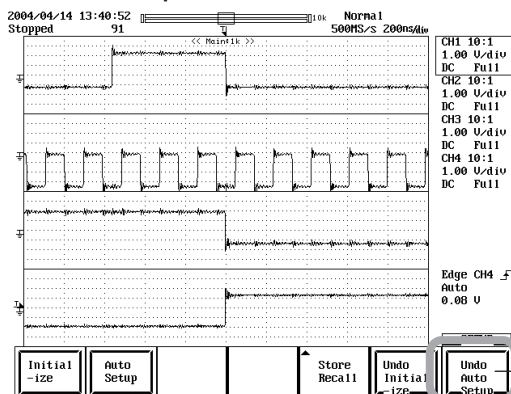

Cancels auto setup

### Canceling Auto Setup

- Press the **Undo Auto Setup** soft key. The settings are set back to their original condition.



### **Explanation**

The auto setup function automatically sets the key settings such as V/div, T/div, and trigger level that are appropriate for the input signal.

#### **Center Position after Auto Setup**

The center position after auto setup is 0 V.

#### **Applicable Channels**

Auto setup is performed on all channels.

#### **Loaded Waveforms**

After Auto Setup, loaded waveforms are unloaded. Press the Undo Auto Setup soft key to recover unloaded waveforms.

#### **Canceling Auto Setup**

Pressing the Undo Auto Setup soft key sets the instrument back to the conditions that existed immediately before auto setup. However, when you turn OFF the power switch, the settings that existed immediately before auto setup are cleared. Therefore, the "Undo Auto Setup" operation is not possible in this case.

#### **Applicable Waveforms for Auto Setup**

Frequency:	Approximately 50 Hz or higher
Absolute value of the input voltage:	Maximum value is greater than or equal to approximately 20 mV (1:1)
Type:	Repetitive waveform (not complex)
Input coupling:	DC

#### **Note**

---

The auto setup function may not work properly if the waveform includes DC components or high-frequency components.

---

**Setup Data after Executing Auto Setup****Waveform acquisition/display conditions**

Acquisition mode	Normal
Acquisition count	Infinite
Record length	10 k
Interleave mode	OFF
Time base	Int
Accumulate mode	OFF
Zoom target	Channels whose display is ON (waveforms whose Allocation on the ZOOM menu is OFF are not displayed).

**Vertical-axis settings**

V/div	Value that causes the absolute value of the input waveform to be 1.6 to 4 divisions
Offset voltage	0 V
Coupling	Other than DC50 $\Omega$ : DC 1 M $\Omega$ ; DC 50 $\Omega$ , DC 50 $\Omega$
Bandwidth limit	FULL
Display ON/OFF	Turns ON channels whose absolute value of the input voltage is greater than or equal to 20 mV (1:1)
Position	0 divisions

**Horizontal-axis settings**

T/div	Value that the displays 1.6 to 4 periods of the waveform with the shortest period of the auto setup target waveforms
-------	--

**Trigger settings**

Trigger mode	Auto
Trigger type	Simple
Trigger source	Channel whose waveform amplitude is greater than or equal to one division with the longest period
Trigger level/slope	Center level between the maximum and minimum values/rising
Trigger coupling	DC
HF rejection	OFF
Hysteresis	<input checked="" type="checkbox"/>
Hold off time	80 ns
Trigger position	50%
Trigger delay	0 s
Trigger gate	OFF

**Computation settings**

Scaling	auto
---------	------

Items other than those listed above are not applicable for auto setup.

## 4.6 Performing Calibration

### Procedure

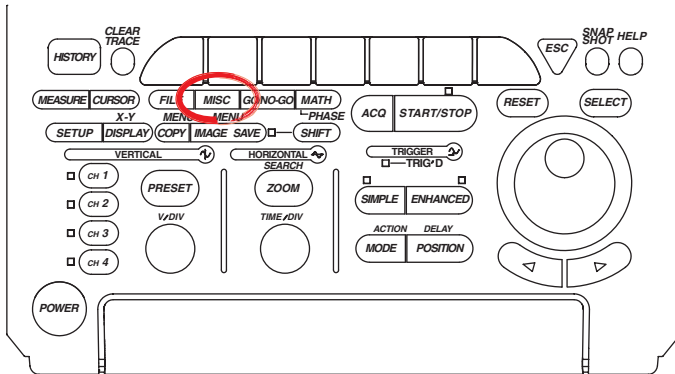

- To exit the menu during operation, press **ESC** located above the soft keys.
- For a description of the operation using a USB keyboard or a USB mouse, see section 4.3.

1. Press the **MISC** key. The MISC menu appears.
2. Press the **Calibration** soft key. The Calibration menu appears.

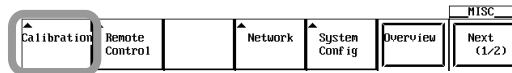

3. Press the **Auto Cal** soft key to select ON or OFF.



4. Press the **Cal Exec** soft key. Calibration is executed.

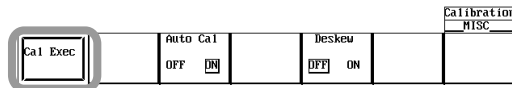

**Explanation****Calibration**

The following items are calibrated. Perform calibration when you wish to measure waveforms with high accuracy.

- Ground level and gain of the vertical axis
- Trigger threshold level
- Time measurement value during repetitive sampling

**Note**

The calibration described above is performed automatically when the power switch is turned ON.

**Precautions to Be Taken When Performing Calibration**

- Always allow the instrument to warm up for at least thirty minutes after the power is turned ON before starting calibration. If calibration is performed immediately after the power is turned ON, the calibration may be inaccurate due to drift caused by fluctuation in the temperature of the instrument.
- Calibration must be performed when the temperature of the instrument is stable and is between 5 and 40°C (preferably at 23°C ± 2°C).
- Do not apply a signal when performing calibration. Calibration may be executed incorrectly when an input signal is being applied.

**Auto Calibration**

Calibration is automatically performed when T/div is changed and waveform acquisition is started for the first time after the following time elapses after turning ON the power.

- 3 minutes
- 10 minutes
- 30 minutes
- 1 hour and every hour thereafter

If calibration was executed while a signal was being applied, it is recommended that the instrument be recalibrated without applying a signal.

## 4.7 Correcting the Delay Time of the Input Signals

### Procedure

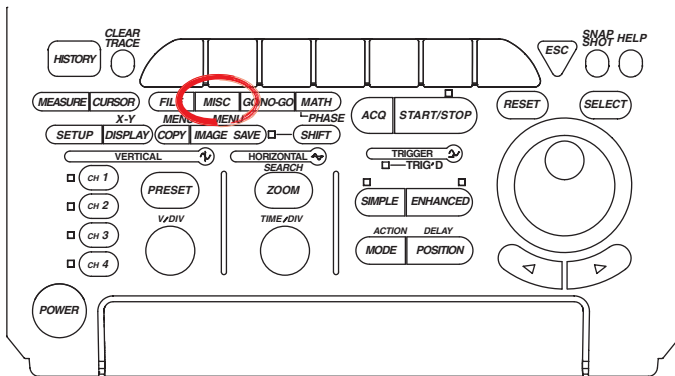

- To exit the menu during operation, press **ESC** located above the soft keys.
- For a description of the operation using a USB keyboard or a USB mouse, see section 4.3.

1. Press the **MISC** key. The MISC menu appears.
2. Press the **Calibration** soft key. The Calibration menu appears.



3. Press the **Deskew** soft key to select ON or OFF.
  - If you select ON, proceed to step 4.
  - If you select OFF, the procedure is complete.



4. Press the **Target CH** soft key. The Target CH menu appears.

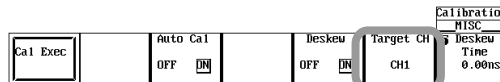

5. Press the CH1 to CH4(2) soft key to select the target channel.

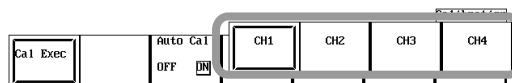

6. Turn the **jog shuttle** to set the Deskew Time.

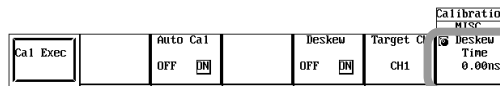

### ***Explanation***

You can use the deskew function to minimize the effects (skew) of the delay time of the input signals due to the probe or other factors, and observe the input signal.

You can correct the delay time of the signals on CH1 through CH4(2).

You can select up to CH2 on the DL1720E and up to CH4 on the DL1740E/DL1740EL, respectively.

### **Selectable Range of Skew Correction**

The correction time can be set in the following range.

-100 ns to 100 ns (resolution is 0.01 ns)

## 4.8 Using the Help Function

### Procedure

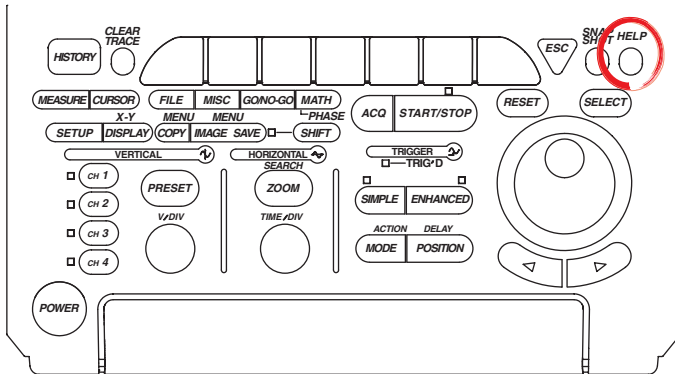

- To exit the menu during operation, press **ESC** located above the soft keys.
- For a description of the operation using a USB keyboard or a USB mouse, see section 4.3.

### Displaying the Help Window

1. Press **HELP**. The help window appears.
2. Press the panel key or soft key that you wish to review.

### Clearing the Help Window

3. Press **HELP** again. The help window disappears.

### Explanation

#### Displaying the Help Window

When you press the **HELP** key, a help window containing information about the soft key menu or jog shuttle menu that was displayed immediately before **HELP** was pressed appears.

If you press a key while the help window is displayed, the help window shrinks. If you press a key while the small help window is displayed, a help window containing information about the key appears.

#### Clearing the Help Window

If you press the **HELP** key again while a help window is displayed, the help window closes.

# 5.1 Turning Channels ON and OFF

## Procedure

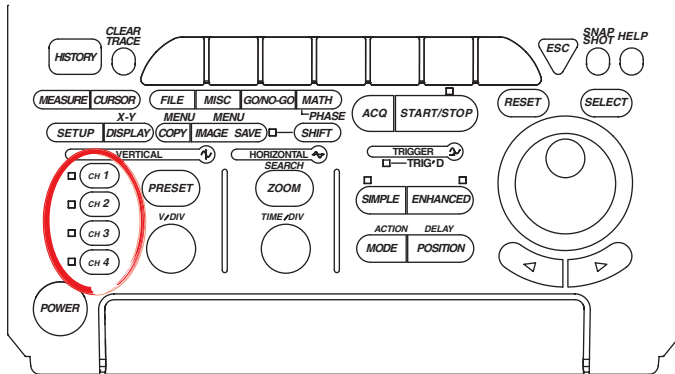

- To exit the menu during operation, press **ESC** located above the soft keys.
- For a description of the operation using a USB keyboard or a USB mouse, see section 4.3.

1. Press one of the **CH1 to CH4(2)** keys to select the channel. The CH menu appears.
2. Press the **Display** soft key to select ON or OFF. You can also turn ON/OFF the channel by pressing **CH1 to CH4(2)** twice.

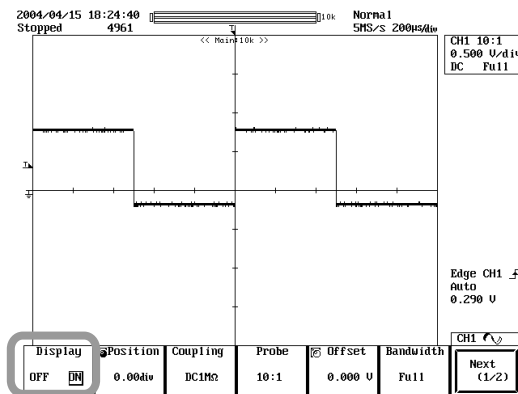

## Explanation

For channels that are turned ON, the LED to the left of the channel key illuminates. You can simultaneously display the waveforms input on channels 1 through 4 (or channels 1 and 2 for the DL1720E). For channels that are turned ON, the LED to the left of the channel key illuminates.

## Note

- The screen can be split into up to six display areas (or up to three on the DL1720E) using the DISPLAY menu (see section 8.1). Scale values (see section 8.8) and waveform labels (see section 8.9) can also be displayed.
- If waveforms are recalled from the history waveforms or loaded from a storage medium such as a floppy disk or PC card, the input waveform cannot be displayed. To compare them, you can use the Snapshot function (see section 8.6).



## 5.2 Setting V/div

<For a description of this function, refer to page 2-3.>

### Procedure

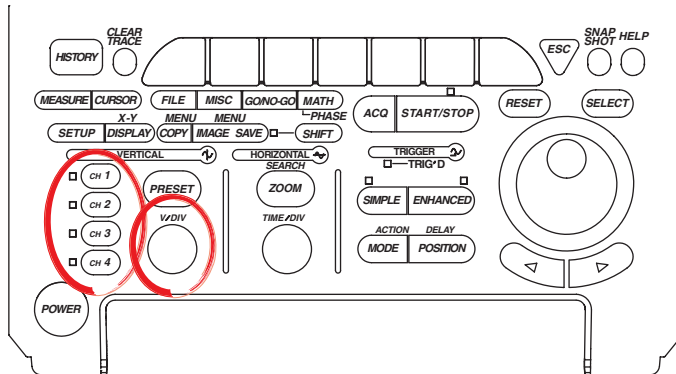

- To exit the menu during operation, press **ESC** located above the soft keys.
- For a description of the operation using a USB keyboard or a USB mouse, see section 4.3.

### Using the V/div Knob

1. Press one of the **CH1 to CH4(2)** keys to select the channel. The CH menu appears.
2. Turn the **V/DIV knob** to set the V/div value.

### Note

- The displayed waveforms do not change if you change the V/div value while the waveform acquisition is stopped. The new V/div value takes effect the next time the waveform acquisition is started.
- Turning the V/DIV knob while acquisition is stopped has no effect on cursor measurement values and automated measurement values of waveform parameters. The displayed values are for the original V/div setting.

### Using the Variable Soft Key

1. Press one of the **CH1 to CH4(2)** keys to select the channel. The CH menu appears.
2. Press the **Next (1/2)** soft key.

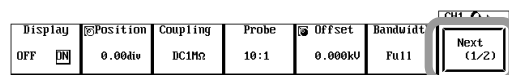

3. Press the **Variable** soft key.

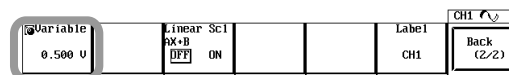

4. Turn the **jog shuttle** to set the V/div value.

### Note

- If you change the V/div value by turning the V/DIV knob, the Variable setting is cancelled.
- If you press the RESET key, the V/div value set using the Variable soft key is reset, and the value returns to the initial V/div value set using the V/DIV knob.

## Explanation

The V/div (A/div when current probes are used) setting is used to adjust the displayed amplitude of the waveform for easy viewing. You can set the value in terms of the voltage (current) per division of the screen grid.

There are two methods for setting this value.

### Setting Using the V/div Knob

V/div is set in steps of 1-2-5 (1 V/div → 2 V/div → 5 V/div).

This value becomes the reference for the selectable range of settings using Variable (see the next section) and the setup step (resolution).

#### • Selectable Range of V/div

The table below shows the selectable range according to the probe attenuation/ current to-voltage conversion ratio setting (see section 5.5).

Probe attenuation	Setting range (when input coupling AC1 M $\Omega$ or DC1 M $\Omega$ is selected):	Setting range (when input coupling DC50 $\Omega$ is selected):
1:1	2 mV/div to 10 V/div:	2 mV/div-1 V/div
10:1	20 mV/div-100 V/div	20 mV/div-10 V/div
100:1	0.2 V/div-1 kV/div	0.2 V/div-100 V/div
1000:1	2 V/div-10 kV/div	2 V/div-1 kV/div

Probe current-to-voltage conversion ratio	Setting range (when input coupling AC1 M $\Omega$ or DC1 M $\Omega$ is selected):	Setting range (when input coupling DC50 $\Omega$ is selected):
10A:1	20 mA/div-100 A/div	20 mA/div-10 A/div
100A:1	0.2 A/div-1 kA/div	0.2 A/div-100 A/div

### Using the Variable Command in the CH Menu

The variable command allows the V/div (A/div) values to be set in smaller steps than the setting entered using the V/div knob. It can also be used to expand/reduce the displayed waveform vertically after waveform acquisition.

Waveform acquisition can be started using the modified V/div (A/div) setting.

#### • Setting Range and Steps

The table below shows the values for the case when the probe attenuation is 10:1.

Setting Using the V/div Knob	Selectable Range Using Variable	Setting Steps
20 mV/div	2.0 mV-50.0 mV	0.2 mV
50 mV/div	5.0 mV-100.0 mV	0.5 mV
100 mV/div	10 mV-200 mV	1 mV
200 mV/div	20 mV-500 mV	2 mV
500 mV/div	50 mV-1000 mV	5 mV
1 V/div	0.10 V-2.00 V	0.01 V
2 V/div	0.20 V-5.00 V	0.02 V
5 V/div	0.50 V-10.00 V	0.05 V
10 V/div	1.0 V-20.0 V	0.1 V
20 V/div	2.0 V-50.0 V	0.2 V
50 V/div	5.0 V-100.0 V	0.5 V
100 V/div	10 V-200 V	1 V

- The values are 1/10th, 10 times, and 100 times the values shown above if the probe attenuation is 1:1, 100:1, and 1000:1, respectively.
- If the probe current-to-voltage conversion ratio is 10 A: 1 V (0.01 V/A), the values are the same values shown above with the unit changed to A. If the ratio is 100 A: 1 V (0.01 V/A), the values are ten times the values shown above with the unit changed to A.

## 5.3 Setting the Vertical Position of the Waveform

<For a description of this function, refer to page 2-3.>

### Procedure

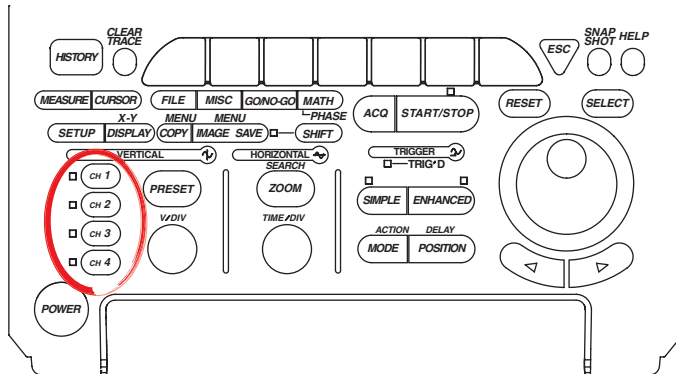

- To exit the menu during operation, press **ESC** located above the soft keys.
- For a description of the operation using a USB keyboard or a USB mouse, see section 4.3.

1. Press one of the **CH1 to CH4(2)** keys to select the channel. The CH menu appears.
2. Press the **Position** soft key to set Position as the item under jog shuttle control.

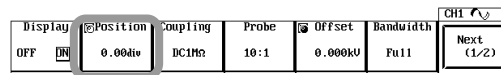

3. Turn the **jog shuttle** to set the vertical position.

**Explanation****Range of Movement**

The vertical position can be moved within a range of  $\pm 4$  divisions from the center of the waveform display frame.

**Resolution**

0.01 divisions

**Confirming the Vertical Position**

For input waveforms and computed waveforms, the ground level and vertical position are marked to the left of the waveform display frame.

500 mV/div, Offset: -1 V, Offset Cancel: OFF, Position: 0 div

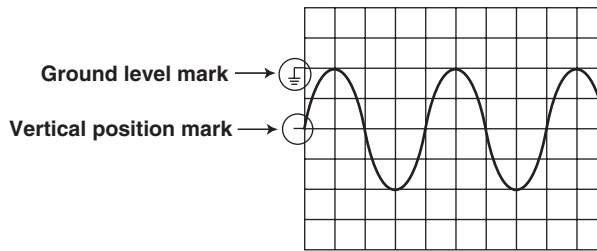
**Note**

- The waveform data that goes off the waveform display frame when moving the vertical position is handled as overflow data.
- If the display waveform goes out of the waveform display frame from moving the vertical position during waveform acquisition, a chopped waveform is displayed as shown in the following figure even if the vertical position is returned to its original position after stopping the acquisition.

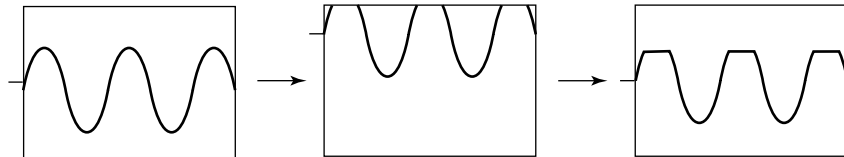

- Changing the vertical position also changes the valid data range. For details, see section 2.2.

## 5.4 Setting the Input Coupling

<For a description of this function, refer to page 2-4.>

### Procedure

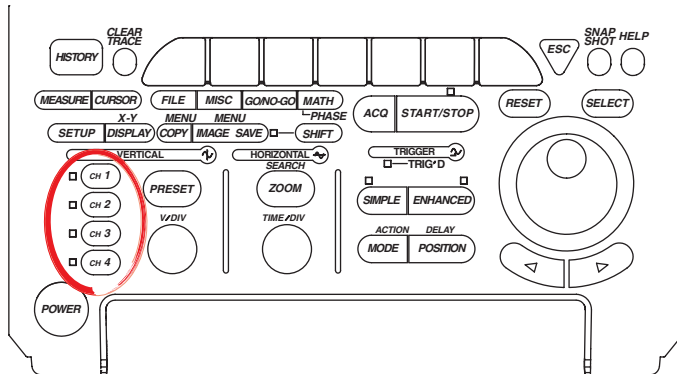

- To exit the menu during operation, press **ESC** located above the soft keys.
- For a description of the operation using a USB keyboard or a USB mouse, see section 4.3.

1. Press one of the **CH1 to CH4(2)** keys to select the channel. The CH menu appears.
2. Press the **Coupling** soft key. The Coupling menu appears.

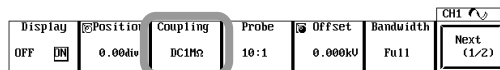

3. Press the soft key corresponding to the desired coupling.  
If DC50  $\Omega$  is selected, a menu used to confirm the execution appears. Press the Set to DC50  $\Omega$  or Cancel soft key.

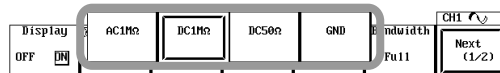

**Explanation****Selecting the Input Coupling**

You can select the method of coupling the input signal to the vertical control circuit from the following.

AC1 M $\Omega$ : Acquires and displays only the AC component of the input signal.

DC1 M $\Omega$ : Acquires and displays all the components (DC and AC) of the input signal (1 M $\Omega$  input).

DC50  $\Omega$ : Acquires and displays all the components (DC and AC) of the input signal (50  $\Omega$  input).

GND: Checks the ground level.

**Input Coupling and Frequency Characteristics**

The frequency characteristics when AC1M $\Omega$ , DC50 $\Omega$ , and DC1M $\Omega$  is selected are shown below.

Note that when AC1M $\Omega$  is selected, low frequency signals or signal components are not acquired (as shown in the figure below).

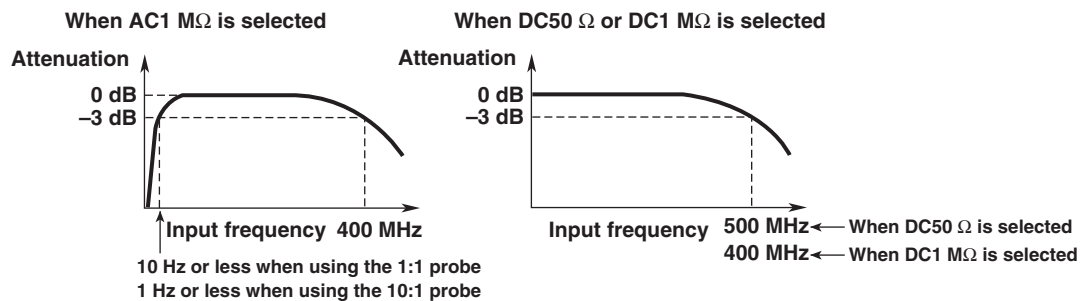
**CAUTION**

The maximum input voltage for 1-M $\Omega$  input when the frequency is 1 kHz or less is 400 V (DC + AC<sub>peak</sub>) or 5 V<sub>rms</sub> or 10 peak for 50  $\Omega$  input. Applying a voltage exceeding either of the two values can damage the input section. If the frequency is above 1 kHz, damage may occur even when the voltage is below this value.

## 5.5 Selecting the Probe Attenuation/Current-to-Voltage Conversion Ratio

<For a description of this function, refer to page 2-5.>

### Procedure

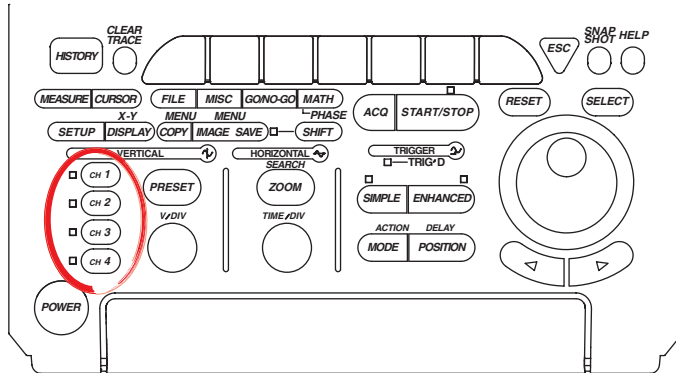

- To exit the menu during operation, press **ESC** located above the soft keys.
- For a description of the operation using a USB keyboard or a USB mouse, see section 4.3.

1. Press one of the **CH1 to CH4(2)** keys to select the channel. The CH menu appears.
2. Press the **Probe** soft key. The Probe menu appears.

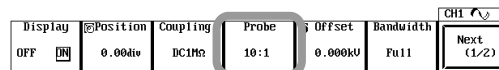

3. Press the soft key corresponding to the desired attenuation/current-to-voltage conversion ratio, then set the attenuation ratio.

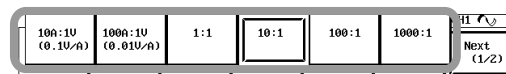

### Explanation

You can select the attenuation or the current-to-voltage conversion ratio of the probe of each channel according to the probe being used from the following.

Probe attenuation: 1:1, 10:1, 100:1, 1000:1

Probe current-to-voltage conversion ratio: 10A:1 V(0.1 V/A)\*, 100A:1 V(0.01 V/A)\*

\* The output voltage of the supported current probe is indicated inside the parentheses.

### Note

If the attenuation or the current-to-voltage conversion ratio is not set correctly, the voltage and scale values of the input signals will not be displayed correctly. For example, if you set the attenuation to 1:1 when you are actually using a 10:1 probe, the displayed value for the waveform amplitude will be 1/10th the actual value.

## 5.6 Setting the Offset Voltage

<For a description of this function, refer to page 2-5.>

### Procedure

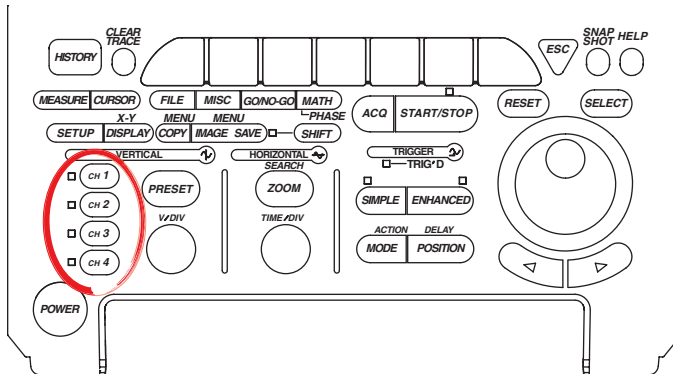

- To exit the menu during operation, press **ESC** located above the soft keys.
- For a description of the operation using a USB keyboard or a USB mouse, see section 4.3.

### Setting the Offset Voltage Value

1. Press one of the **CH1 to CH4(2)** keys to select the channel. The CH menu appears.
2. Press the **Offset** soft key.

Display	Position	Coupling	Probe	Offset	Bandwidth	CH1
OFF	0.00div	DC1Ms	10:1	0.000kV	Full	Next (1/2)

3. Turn the **jog shuttle** to set the offset voltage.

### Resetting the Offset Voltage Value

4. Press **RESET**. The offset voltage is set to 0 V.



### Explanation

The offset voltage setting applies to all input couplings (AC1 M $\Omega$ , DC1 M  $\Omega$ , DC 50  $\Omega$ , and GND).

#### Selectable Range of Offset Voltage

Voltage Axis Sensitivity (Probe = 1:1)	Offset Voltage Selectable Range
2 mV/div to 50 mV/div	-1.0 V to 1.0 V
0.1 V/div to 0.5 V/div	-10.0 V to 10.0 V
1 V/div to 10 V/div	-100.0 V to 100.0 V (except 1/V/div only for DC50 $\Omega$ )

- The resolution is 0.01 divisions. For 2 mV/div, the resolution is 0.02 mV.
- The values are 10 times, 100 times, and 1000 times the values shown above when the probe attenuation is 10:1, 100:1, and 1000:1, respectively. If the probe current-to-voltage conversion ratio is 10 A: 1 V, the values are the same 10 times the values shown above with the unit changed to A. If the ratio is 100 A: 1 V, the values are 100 times the values shown above with the unit changed to A.

#### Resetting the Offset Value

Pressing the RESET key resets the offset value to 0 V.

#### Notes on Setting the Offset Voltage

- Only the display position changes when acquisition is stopped. The new offset voltage is applied to the acquired data the next time waveform acquisition is started.
- You can select whether to apply the offset voltage to cursor measurement values, automated measurement values of waveform parameters, and computation. See section 15.3.
- If you change the probe attenuation, the offset changes proportionally to reflect the new attenuation rate.
- If you change the vertical axis sensitivity after setting the offset voltage value, the offset voltage value does not change.
- The selectable range and resolution of the offset voltage value vary depending on the vertical axis sensitivity setting.

The behavior when you change the vertical axis sensitivity after setting the offset voltage value is indicated below. If you change the vertical axis sensitivity back to the original setting without changing the offset voltage value, the original offset voltage value returns.

- When the vertical axis sensitivity is increased (the value is decreased) and the specified offset value exceeds the selectable range of the offset voltage at the new vertical axis sensitivity, the offset voltage is set to the maximum value of the selectable range of the offset value at the new vertical axis sensitivity.
- When the vertical axis sensitivity is decreased (the value is increased) and the specified resolution of the offset value falls below the resolution of the offset value at the new vertical axis sensitivity, the resolution is set to the resolution of the offset voltage at the new vertical axis sensitivity.

## 5.7 Using the Preset Function

### Procedure

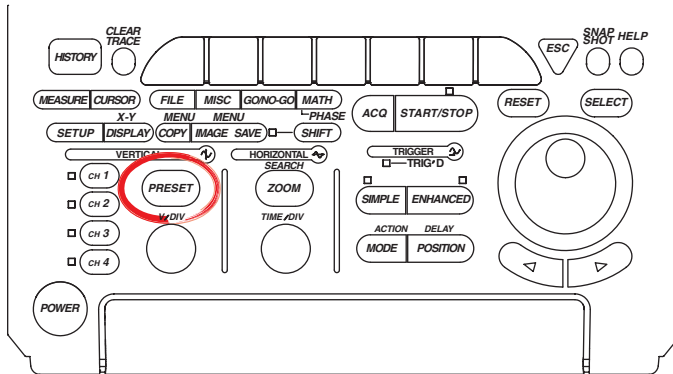

- To exit the menu during operation, press **ESC** located above the soft keys.
- For a description of the operation using a USB keyboard or a USB mouse, see section 4.3.

### Selecting Channels

1. Press **PRESET**. The PRESET menu appears.
2. Press the **Select** soft key. The Select menu appears.

Select	Type	Probe	U/div	Offset	Trig Lvl	PRESET
All	CHOS(SU)	10:1	2.00 V	0.00 V	2.50 V	Exec

3. Press the **All** or **CH1 to CH4(2)** soft key to select the channel for setting the preset. Pressing All will select all the channels. The CH3 and CH4 soft keys are not displayed on the DL1720E.

All	CH1	CH2	CH3	CH4	Trig Lvl	PRESET
					2.50 V	Exec

### Selecting the Probe Attenuation/Current-to-Voltage Conversion Ratio

4. Press the **Probe** soft key. The Probe menu appears.

Select	Type	Probe	U/div	Offset	Trig Lvl	PRESET
All	CHOS(SU)	10:1	2.00 V	0.00 V	2.50 V	Exec

5. Press the soft key corresponding to the desired attenuation/current-to-voltage conversion ratio.

100:1V (0.1U/A)	1000:1V (0.01U/A)	1:1	10:1	100:1	1000:1	PRESET
						Exec

## 5.7 Using the Preset Function

### Selecting the Preset Type

- Press the **Type** soft key. The Type menu appears.

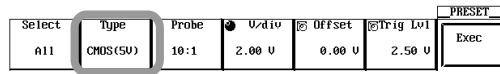

- Press the **CMOS(5 V)**, **CMOS(3.3 V)**, **ECL**, or **User** soft key.

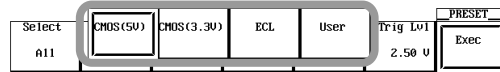

If you selected User for Type in step 7, proceed to step 8. If you selected a Type other than user, proceed to step 12.

### Setting V/div, the Offset Voltage, and the Trigger Level (When Type is Set to User)

- Press the **V/div** soft key.
- Turn the **jog shuttle** to set the V/div value.



- Press the **Offset** or **Trig Lvl** soft key.
- Turn the **jog shuttle** to set the offset voltage or trigger level.

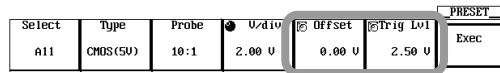

### Executing Presets

- Press the **Exec** soft key to execute the presets.

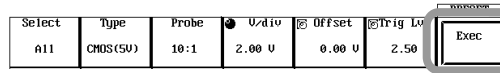

### Note

If you selected User for the Type in step 7, Type automatically reverts to User when the V/div, Offset, or Trig Lvl settings are changed.

**Explanation**

The key settings of V/div, input coupling, trigger level, and other items are automatically set to the optimum values (or arbitrary values) for the CMOS signal or ECL signal. You can also automatically set them to the optimum values for the current probe 700937, 701930, 701931, or 701932 (sold separately).

You can set each channel separately or set all the channels to the same settings.

**Setup after Executing Preset**

Preset type	CMOS(5 V)	CMOS(3.3 V)	ECL	User
Input coupling	DC1 M $\Omega$	DC1 M $\Omega$	DC1 M $\Omega$	DC1 M $\Omega$
Trigger coupling	DC	DC	DC	DC
Probe	1:1, 10:1, 100:1, 1000:1, 10 A:1 V(0.1 V/A),100 A:1 V Select from (0.01 V/A)			
V/div	2 V/div	1 V/div <sup>1</sup>	200 mV/div <sup>1</sup>	Arbitrary <sup>2</sup>
Offset voltage	0 V	0 V	-1.3 V	Arbitrary <sup>2</sup>
Trigger level	2.5 V	1.65 V	-1.3 V	Arbitrary <sup>2</sup>

1. 2 V/div (2 A/div) for 1000:1.

2. For the selectable ranges, see section 5.2, "Setting V/div," 5.6, "Setting the Offset Voltage," and 6.5, "Setting the Edge Trigger (SIMPLE)."

## 5.8 Setting the Bandwidth Limit

<For a description of this function, refer to page 2-5.>

### Procedure

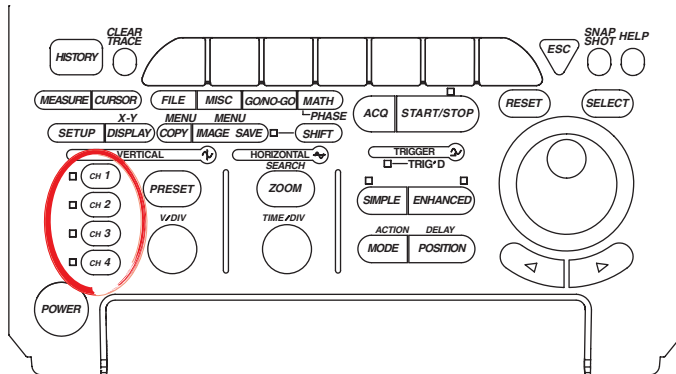

- To exit the menu during operation, press **ESC** located above the soft keys.
- For a description of the operation using a USB keyboard or a USB mouse, see section 4.3.

1. Press one of the **CH1 to CH4(2)** keys to select the channel. The CH menu appears.
2. Press the **Bandwidth** soft key. The Bandwidth menu appears.

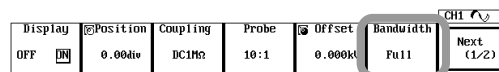

3. Press the **20MHz**, **100 MHz**, or **Full** soft key.

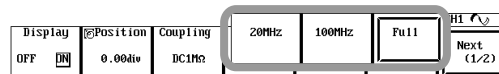

4. As necessary, repeat steps 1 to 3.

### Note

The bandwidth limit is set for each channel. Set the bandwidth limit for all necessary channels.

### Explanation

You can remove high frequency components (20 MHz or more, or 100 MHz or more) from the input signal. The bandwidth limit is set for each channel.

#### Bandwidth Limit

Bandwidth limits of 20 MHz and 100 MHz are available. The frequency characteristics when bandwidth is limited are shown below. If you select Full, the frequency bandwidth is 500 MHz (50 Ω input) or 400 MHz (1-M Ω input).

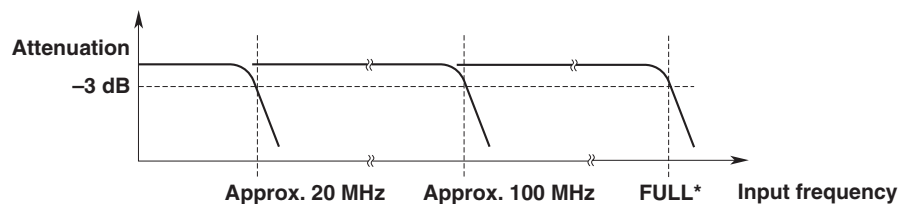

\* 500 MHz at 50 Ω input  
400 MHz at 1 MΩ input

## 5.9 Using the Linear Scaling Function

<For a description of this function, refer to page 2-5.>

### Procedure

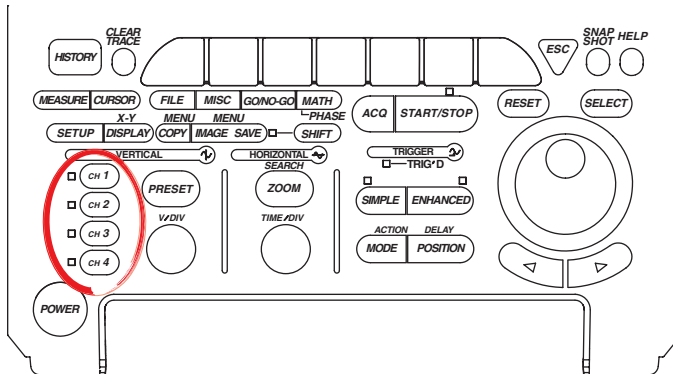

- To exit the menu during operation, press **ESC** located above the soft keys.
- For a description of the operation using a USB keyboard or a USB mouse, see section 4.3.

1. Press one of the **CH1 to CH4(2)** keys to select the channel. The CH menu appears.
2. Press the **Next (1/2)** soft key.

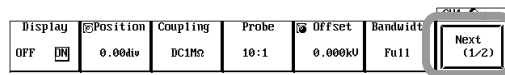

3. Press the **Linear Sc1 AX+B** soft key to select ON.



4. Press the **A/B** soft key to set the jog shuttle control to A.
5. Turn the **jog shuttle** to set the A value.
6. Likewise, set the B value.
7. To attach a unit, press the **Unit** soft key to display the keyboard and enter the unit name.

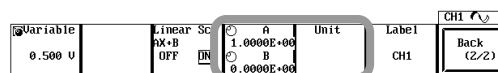

### Note

- Linear scaling is not available for the following waveforms.
  - Snapshot waveforms
  - Accumulated waveforms (however, linear scaling is possible on the accumulated waveform acquired last.)
- Linear scaling is set for each channel.
- The scaling coefficient A and offset value B that you entered are held even if you turn OFF the linear scaling function.
- Computation is performed using the linear scaling results.

## 5.9 Using the Linear Scaling Function

---

### **Explanation**

The computation shown below is executed using the specified scaling coefficient A and offset B. The cursor measurement values and automated measurement values of waveform parameters are displayed using the scaled values. Also, units can be added to the displayed linear scaling results.

$$Y=AX+B \quad (\text{where } X \text{ is the measured value and } Y \text{ is the linear scaling result})$$

### **Setting Scaling Coefficient A and Offset Value B**

Selectable range of A and B:  $-9.9999E+30$ - $+9.9999E+30$

Default settings:           A 1.0000E+00  
                                  B 0.0000E+00

### **Setting the Unit**

You can set the unit using up to four alphanumeric characters.

### **Displaying the Scale Value**

The upper and lower limits of the vertical axis of each channel can be displayed using linear-scaled values (see section 8.8).

## 5.10 Selecting the Time Base

<For a description of this function, refer to page 2-6.>

### Procedure

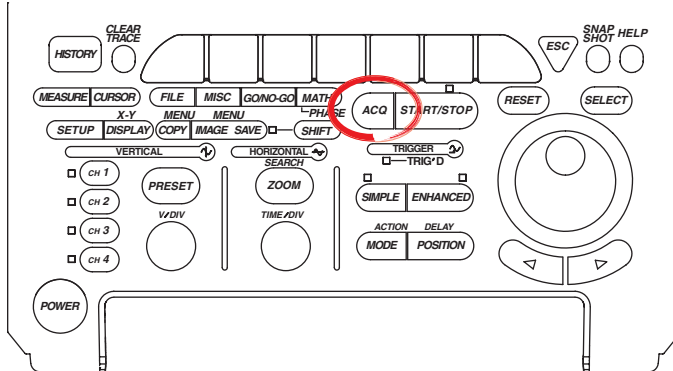

- To exit the menu during operation, press **ESC** located above the soft keys.
- For a description of the operation using a USB keyboard or a USB mouse, see section 4.3.

1. Press **ACQ**. The ACQ menu appears.
2. Press the **Time Base** soft key to select Int or Ext.

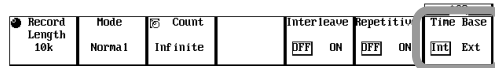

### Setting the Threshold Level When Using an External Clock

3. Press **SIMPLE**. In the menu that appears, set the trigger source to EXT and set the level.

This operation is common with the trigger level settings. For details on the Procedure, see section 6.6.

### Explanation

#### Selecting the Time Base

You can select from the following.

Int: Internal clock signal

Ext: Clock signal applied to the external clock input terminal

#### When Setting the External Clock Signal as the Time Base

Apply a clock signal of the following specifications to the EXT CLOCK IN/EXT TRIG IN/TRIG GATE IN terminal on the rear panel (shared with the external trigger input, or the EXT. terminal on the front panel of the DL1720E).

Item	Description
Connector type	BNC
Maximum allowable input voltage	$\pm 40$ V (DC+ACpeak) or 28 Vrms when the frequency is 10 kHz or
Frequency range	40 Hz to 20 MHz (continuous clock only)
Minimum input amplitude	0.1 Vp-p
Input impedance	Approximately 1 M $\Omega$ and approximately 20 pF
Threshold level	$\pm 2$ V, setting resolution is 5 mV (on the DL1740E/DL1740EL) $\pm 1$ V, setting resolution is 5 mV (when the $\pm 1$ V range set on the DL1720E) $\pm 10$ V, setting resolution is 50 mV (when the $\pm 10$ V range set on the DL1720E)
Sampling jitter	$\pm 1.25$ ns or less
Minimum pulse width	10 ns or more for high and low



## 5.10 Selecting the Time Base

[Input terminal]

For the DL1740E/DL1740EL  
(terminal on the rear panel)

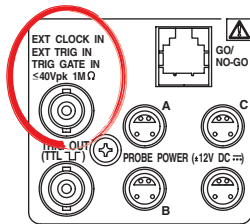

For the DL17420E

(terminal on the front panel)

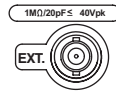

### CAUTION

Applying a voltage that exceeds the maximum allowable input voltage indicated on the previous page to the EXT TRIG IN/EXT CLOCK IN/TRIG GATE IN terminal (or the EXT terminal on the DL1720E) can damage the input section.

#### Notes on Sampling with an External Clock

- The clock signal must be a continuous clock signal. Burst signals cannot be applied.
- Only realtime sampling mode can be used.
- You cannot set the acquisition mode to Envelope or Box Average.
- You cannot display waveforms in roll mode.
- No function is provided for frequency-dividing the clock signal.
- Since the time axis setting cannot be changed, zoom in/out of the time axis when you wish to change the display range of the time axis. For the zoom Procedure, see section 8.4.
- You cannot set a trigger delay.
- You cannot use the deskew function.
- The time measured by the cursor measurement or automated measurement of waveform parameters is expressed in the number of pulses of the clock signal. No unit is displayed.
- The threshold level for the external clock input and the trigger level for the external trigger input are common.

## 5.11 Setting T/div

<For a description of this function, refer to page 2-6.>

### Procedure

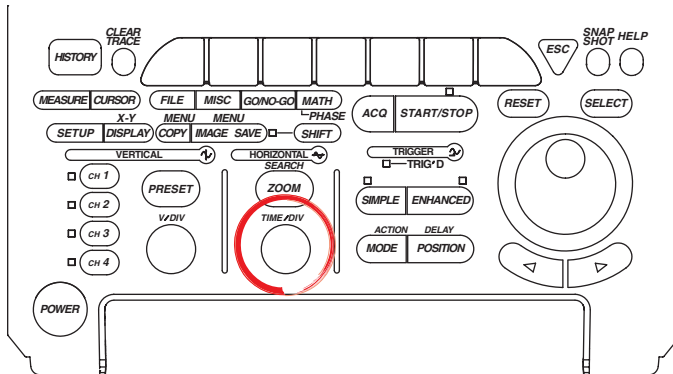

- To exit the menu during operation, press **ESC** located above the soft keys.
- For a description of the operation using a USB keyboard or a USB mouse, see section 4.3.

1. Turn the **TIME/DIV knob** to set the T/div.

### Note

If the TIME/DIV knob is turned while the waveform acquisition is stopped, the new T/div value is displayed inside the parentheses at the upper right corner of the screen. The new T/div value becomes valid the next time waveform acquisition is started.

### Explanation

You can set the value in terms of time per div (divisions) of the screen grid.

#### Selectable T/div Range

1 ns/div to 50 s/div in 1-2-5 steps (when the record length is greater than or equal to 10 kW)

1 ns/div to 5 s/div in 1-2-5 steps (when the record length is equal to 1 kW)

#### T/div and Sampling Mode

The maximum sample rate when repetitive sampling is OFF (see section 7.5) is 500 MS/s (or 1 GS/s when interleave mode is ON). In repetitive sampling mode, you can set the sample rate to 1 GS/s or more (or 2 GS/s or more when interleave mode is ON).

However, the time axis range that allows repetitive sampling mode varies depending on the model and record length setting. For details, see appendix 1.

### Note

When you change the T/div setting, repetitive sampling mode may be automatically enabled even when repetitive sampling is set to OFF (see appendix 1).

#### T/div and Roll Mode

Under the following three conditions, roll mode display is enabled for the T/div settings listed below.

- When the acquisition mode (see section 7.5) is something other than Average.
- When the number of waveform acquisitions (see section 7.5) is set to Infinite.
- When the trigger mode (see section 6.1) is set to Auto, Auto Level, or Single.

Record length	T/div
1 kWord	50 ms/div to 5 s/div
10 k to 1 MWord	50 ms/div-50 s/div
2 MWord	100 ms/div-50 s/div
4 MWord	200 ms/div-50 s/div
8 MWord	500 ms/div-50 s/div

# 6.1 Selecting the Trigger Mode

<For a description of this function, refer to page 2-11.>

## Procedure

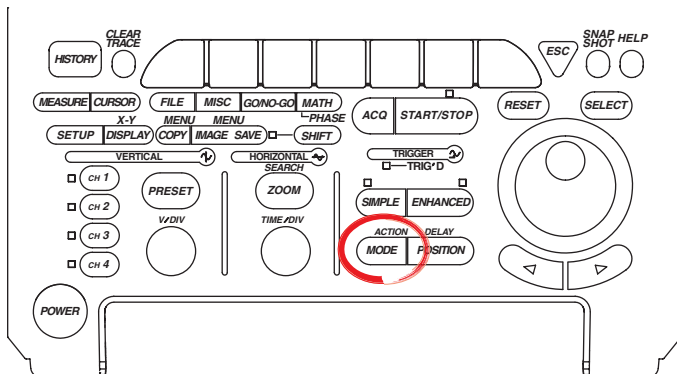

- To exit the menu during operation, press **ESC** located above the soft keys.
- For a description of the operation using a USB keyboard or a USB mouse, see section 4.3.

1. Press **MODE**. The MODE menu appears.
2. Press the soft key corresponding to the desired mode.  
For the Procedure of selecting Single(N), see section 7.6.

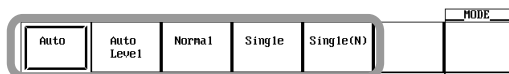

## Explanation

### Auto Mode

If the trigger condition is met within the 100-ms timeout period, the waveform is updated on each trigger occurrence. If the trigger condition is not met after the timeout period elapses, the waveform is automatically updated. If the time axis setting is in the range in which the display mode is set to roll mode, the display is set to roll mode (see page 2-7).

### Auto Level Mode

If a trigger occurs within the timeout period, the waveform is displayed in the same fashion as in auto mode. If a trigger is not activated within the timeout period, then the center value of the amplitude of the trigger source is detected, and the trigger level is changed to that value. A trigger is activated using the new value, and the displayed waveforms are updated. Auto-level mode is valid only if the trigger is a simple trigger and the trigger source is between CH1 and CH4 (or CH1 and CH2 for the DL1720E). For all other cases, the operation is the same as for auto mode.

If the time axis setting is in the range in which the display mode is set to roll mode, the display is set to roll mode.

### Normal Mode

The display is updated only when the trigger conditions are met. The display is not updated if the trigger does not occur. Therefore, to check the waveform or ground level when no trigger is detected, use auto mode.

## 6.1 Selecting the Trigger Mode

---

### **Single Mode**

The display is updated once when the trigger conditions are met and the waveform acquisition stops. In the time axis setting range in which the display is set to roll mode, the display is set to roll mode. When a trigger occurs, the specified record length of data is acquired and the displayed waveform stops.

### **Single(N) Mode**

Select this mode when acquiring waveforms using the sequential store function. For the procedure of selecting this mode, see section 7.6.

### **Note**

---

The trigger mode setting applies to both simple and enhanced triggers.

---

## 6.2 Setting the Trigger Position

<For a description of this function, refer to page 2-12.>

### Procedure

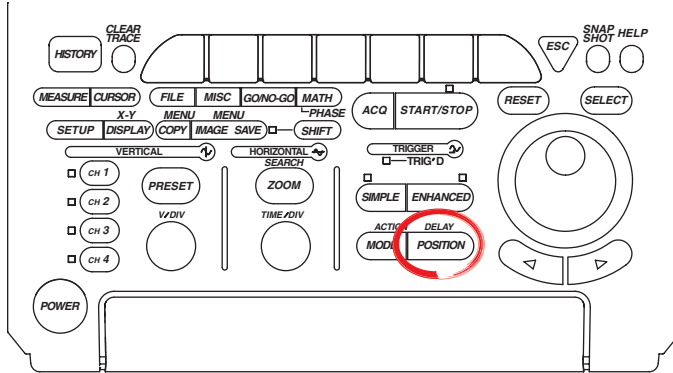

- To exit the menu during operation, press **ESC** located above the soft keys.
- For a description of the operation using a USB keyboard or a USB mouse, see section 4.3.

1. Press **POSITION**. The POSITION menu appears.
2. Turn the **jog shuttle** to set the trigger position.
  - If you wish to select 10%, 50%, or 90%, you can Press the corresponding soft key.
  - Pressing **RESET** resets the value to 50% .

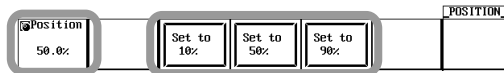

### Explanation

#### Trigger position

Trigger position = Trigger point + trigger delay (delay time).

You can select the location of the trigger position on the screen.

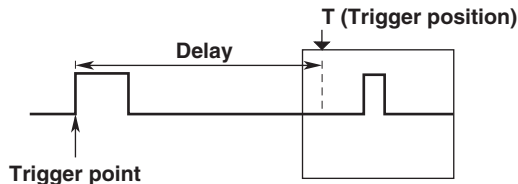

#### Selectable Range of Trigger Position

The trigger position can be set in the range of 0 to 100% (resolution is 0.1%) taking the display record length to be 100%.

#### Display the Trigger Position

The trigger position mark that appears at the top of the screen indicates the trigger position with respect to the display record length.

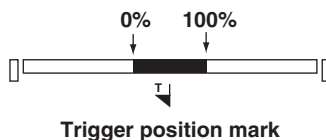

## 6.2 Setting the Trigger Position

---

### Notes on Setting the Trigger Position

- If you change the trigger position while waveform acquisition is stopped, the new setting will not become effective until acquisition is started and the waveform is updated.
- Note that cursor time measurements are with respect to the trigger position. Changing the trigger position therefore changes the measurement values (except when in roll mode display).
- If you change the T/div setting, the time axis setting is rescaled with respect to the trigger position.

## 6.3 Setting the Trigger Delay

<For a description of this function, refer to page 2-12.>

### Procedure

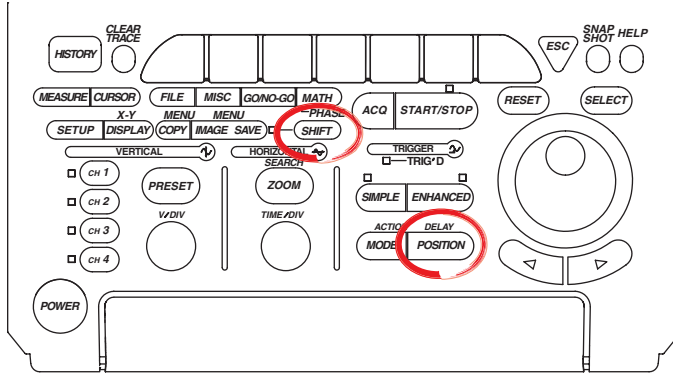

- To exit the menu during operation, press **ESC** located above the soft keys.
- For a description of the operation using a USB keyboard or a USB mouse, see section 4.3.

1. Press **SHIFT + POSITION**. The DELAY menu appears.
2. Press the soft key corresponding to the desired unit of time (ms,  $\mu$ s, ns, or ps).  
If you are not specifying a time unit (ms,  $\mu$ s, ns, or ps), press the DELAY soft key.
2. Turn the **jog shuttle** to set the delay time.  
Pressing RESET resets the value being selected to 0 s.

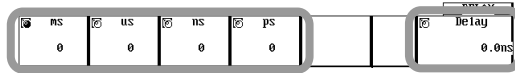

### Explanation

Although the display usually shows the waveform before and after the trigger point, it is possible to display the acquired waveform after a fixed time period elapses using the trigger delay.

#### Selectable Range of Trigger Delay

0 to 4 s (resolution is  $(1/\text{sample rate})/10$ )

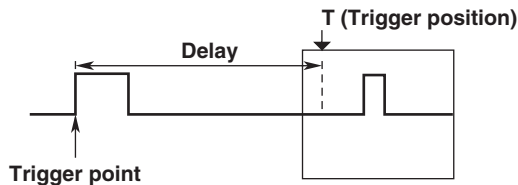

#### Notes on Setting the Trigger Delay

- When T/div is changed, the trigger delay remains unchanged.
- If the time base is set to external clock, the trigger delay cannot be specified (it is fixed at 0 s).

## 6.4 Setting the Hold Off Time

<For a description of this function, refer to page 2-13.>

### Procedure For Simple Triggers

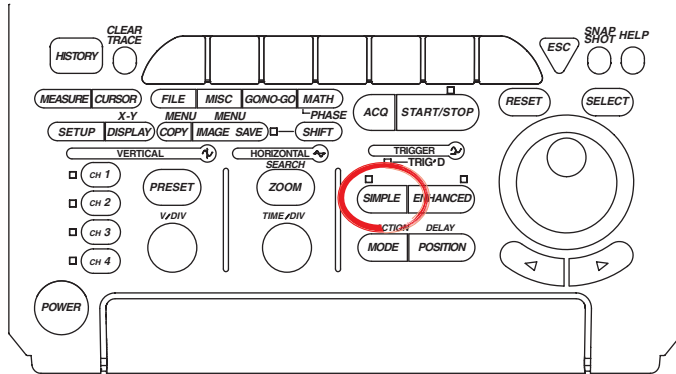

- To exit the menu during operation, press **ESC** located above the soft keys.
- For a description of the operation using a USB keyboard or a USB mouse, see section 4.3.

1. Press **SIMPLE**. The SIMPLE menu appears.
2. Press the **Hold Off** soft key.

Source	Level	Slope	Coupling	HF Reject	Hysteresis	Hold Off (uS)
CH1	1.50 U	f	DC	AC	OFF	0.08

3. Turn the **jog shuttle** to set the hold off time.  
Pressing **RESET** resets the value to 0.08  $\mu$ s.

### For Enhanced Triggers

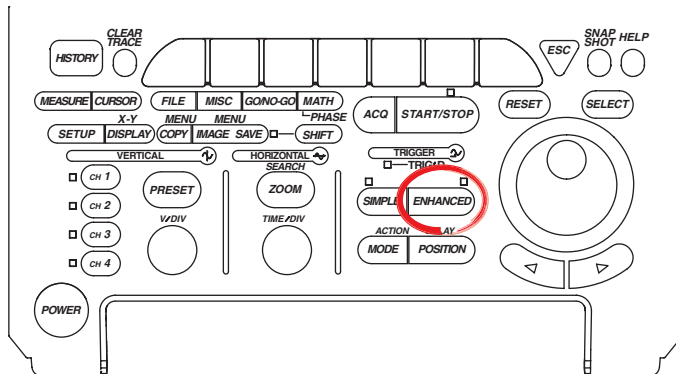

- To exit the menu during operation, press **ESC** located above the soft keys.
- For a description of the operation using a USB keyboard or a USB mouse, see section 4.3.

1. Press **ENHANCED**. The ENHANCED menu appears.
2. Press the **Hold Off** soft key.

Type	Set Pattern	Level/Coupling	Count	Hold Off (uS)
A -> B(N)			1	0.08

3. Turn the **jog shuttle** to set the hold off time.  
Pressing **RESET** resets the value to 0.08  $\mu$ s.

#### Note

The hold off time setting applies to both simple and enhanced triggers.



**Explanation**

As shown in the figure below, this setting prevents a trigger from being activated for a specified time, even when the trigger conditions are met during this time. This is useful when you wish to activate the trigger in sync with a periodic signal as in the figure below.

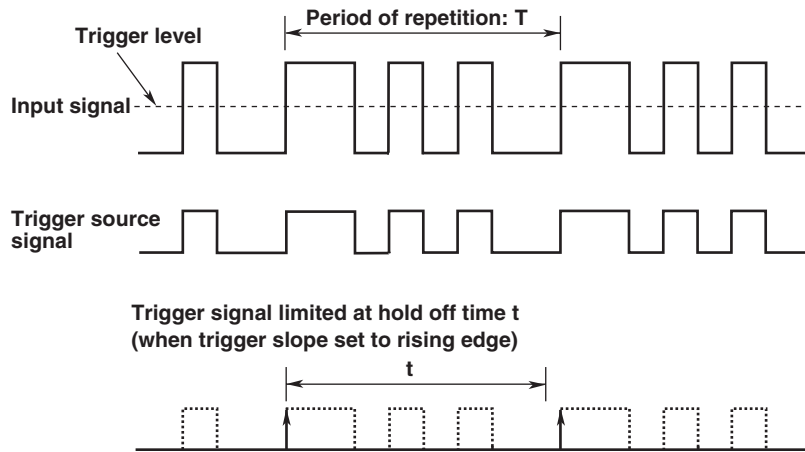
**Selectable Range of the Hold Off Time**

The selectable range is 80 ns to 10 s (the default value is 80 ns), and the resolution is 20 ns.

**Notes on Setting the Hold Off Time**

- The updating of the waveform may slow down when using repetitive sampling. In this case, set the hold off time to a smaller value.
- If you are setting the hold off time to 100 ms or greater, set the trigger mode to normal.
- When used with A->B(N) or A Delay B trigger, the hold off time applies only to condition A.

## 6.5 Setting the Edge Trigger (SIMPLE)

<For a description of this function, refer to page 2-8.>

### Procedure

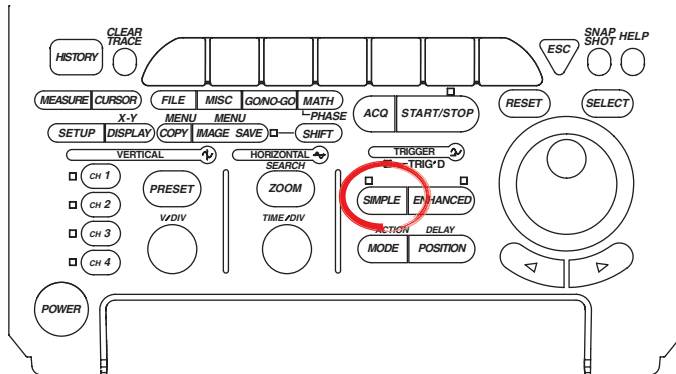

- To exit the menu during operation, press **ESC** located above the soft keys.
- For a description of the operation using a USB keyboard or a USB mouse, see section 4.3.

### Setting the Trigger Source

1. Press **SIMPLE**. The SIMPLE menu appears.
2. Press the **Source** soft key. The Source menu appears.

Source	Level	Slope	Coupling	HF Rejct	Hysteresis	SIMPLE Hold Off (uS)
CH1	1.50 V	f	DC	AC	OFF	0.00

3. Press the soft key corresponding to the desired trigger source. The CH3 and CH4 soft keys are not displayed on the DL1720E.

CH1	CH2	CH3	CH4	Ext	Line	SIMPLE Hold Off (uS)
CH1						0.00

### Setting the Trigger Level

4. Press the **Level** soft key.

Source	Level	Slope	Coupling	HF Rejct	Hysteresis	SIMPLE Hold Off (uS)
CH1	1.50 V	f	DC	AC	OFF	0.00

5. Turn the **jog shuttle** to set the trigger level. Pressing **RESET** resets the trigger level to the current offset voltage.

### Note

The trigger level setting applies to both simple and enhanced triggers.

### Setting the Trigger Slope

6. Press the **Slope** soft key to select  $f$ ,  $\bar{f}$ , or  $f\bar{f}$ .

### Setting the Trigger Coupling

7. Press the **Coupling** soft key to select DC or AC.

Source	Level	Slope	Coupling	HF Rejct	Hysteresis	SIMPLE Hold Off (uS)
CH1	1.50 V	f	DC	AC	OFF	0.00

### Note

The trigger coupling setting applies to both simple and enhanced triggers.

**Setting the HF Rejection**

8. Press the **HF Reject** soft key. The HF Reject menu is displayed.

Source	Level	Slope	Coupling	HF Reject	Hysteresis	SIMPLE Hold OFF (uS)
CH1	1.50 V	f	AC	OFF		0.00

9. Press the soft key corresponding to the desired frequency.

Source	Level	Slope	Coupling	HF Reject	Hysteresis	SIMPLE Hold OFF (uS)
CH1	1.50 V	f	AC	OFF	20kHz	

**Note**

The HF rejection setting applies to both simple and enhanced triggers.

**Setting the Hysteresis**

10. Press the **Hysteresis** soft key to select  $\nabla$  or  $\nabla$ .

Source	Level	Slope	Coupling	HF Reject	Hysteresis	SIMPLE Hold OFF (uS)
CH1	1.50 V	f	AC	OFF	$\nabla$	0.00

**Note**

The Hysteresis setting applies to both simple and enhanced triggers.

**Setting the Hold Off**

11. Set the hold off time according to the procedures given in section 6.4.

**Explanation****Selecting the Trigger Source**

You can select from CH1 to CH4(2).

- For the procedure of setting the external signal applied to the EXT TRIG IN terminal on the rear panel as the trigger source (setting the trigger source to EXT), see section 6.6.
- For the procedure of activating the trigger in sync with the power supplied to the instrument (setting the trigger source to line), see section 6.7.
  - \* The terminal located on the rear panel of the DL1740/DL1740EL, and on the front panel of the DL1720E.

**Setting the Trigger Level**

- The selectable range is eight divisions within the screen. The resolution is 0.01 divisions. For example, the resolution for 2 mV/div is 0.02 mV.
- You can also press the RESET key to reset the trigger level to the current offset voltage.

**Setting the Trigger Slope**

You can select how the trigger source is to cross a specified level for activating the trigger from the following three choices.

- f: Activated when the trigger source changes from below the trigger level to above the trigger level (rising).
- f: Activated when the trigger source changes from above the trigger level to below the trigger level (falling).
- f: Activated on either a rising edge or falling edge.

## 6.5 Setting the Edge Trigger (SIMPLE)

---

### Setting the Trigger Coupling

You can select from the following.

AC: Uses a signal that is obtained by removing the DC component from the trigger source signal.

DC: Uses the trigger source signal as-is.

### Setting the HF Rejection

Specify 15 kHz or 20 MHz if you wish to use a signal that is obtained by removing the high frequency components (frequency components greater than 15 kHz or 20 MHz) from the trigger source signal as the trigger source.

### Setting the Hysteresis

Sets a width to the trigger level so that triggers are not activated by small changes in the trigger signal.

$\overline{\Delta}$ : Approximately 0.3 divisions\* of hysteresis around the trigger level.

$\overline{\nabla}$ : Approximately one division\* of hysteresis around the trigger level.

\* The value above is an approximate value. It is not strictly warranted.

### Setting the Hold Off

See section 6.4.

## 6.6 Setting the External Trigger (SIMPLE)

### Procedure

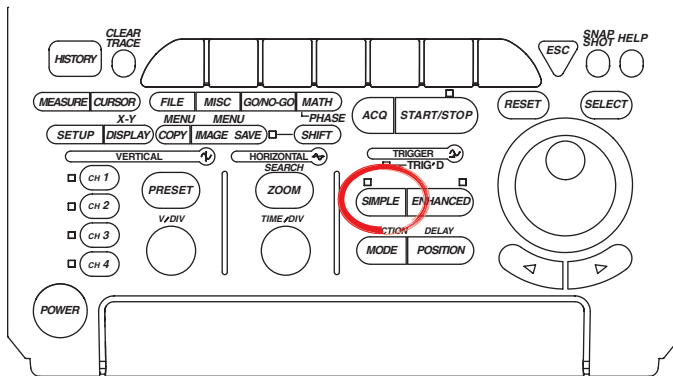

- To exit the menu during operation, press **ESC** located above the soft keys.
- For a description of the operation using a USB keyboard or a USB mouse, see section 4.3.

### Setting the Trigger Source

1. Press **SIMPLE**. The SIMPLE menu appears.
2. Press the **Source** soft key. The Source menu appears.

Source	Level	Slope	Coupling	HF Reject	Hysteresis	SIMPLE
CH1	1.50 V	f	AC	AC	OFF	Hold Off (uS) 0.00

3. Press the **Ext** soft key.  
The CH3 and CH4 soft keys are not displayed on the DL1720E.

CH1	CH2	CH3	CH4	Ext	Line	SIMPLE
						Hold Off (uS) 0.00

### Setting the Trigger Level

4. Press the **Level** soft key.

Source	Level	Slope	Probe	SIMPLE
Ext	0.000 V	f	1:1 10:1	Hold Off (uS) 0.00

On the DL1720E, the Range item is displayed in this position.

5. Turn the **jog shuttle** to set the trigger level.  
Pressing RESET resets the trigger level to 0 V.

### Setting the Trigger Slope

6. Press the **Slope** soft key to select **f**, **↘**, or **f↘**.

### Setting the Probe Attenuation

7. Press the **Probe** soft key to select 1:1 or 10:1.

Source	Level	Slope	Probe	SIMPLE
Ext	0.000 V	f	1:1 10:1	Hold Off (uS) 0.00

## 6.6 Setting the External Trigger (SIMPLE)

---

### Setting the Range (DL1720E)

8. Press the **Range** soft key to select the range.

Select either  $\pm 1$  V or  $\pm 10$  V when 1:1 was selected for the probe, or  $\pm 10$  V or  $\pm 100$  V when 10:1 was selected for the probe.

Source	Level	Slope	Range	Probe	SIMPLE
Ext	0.000 V	f	$\pm 10$ V	10:1	Hold Off (uS) 0.00

### Setting the Hold Off

9. Set the hold off time according to the procedures given in section 6.4, "Setting the Hold Off Time."

### Explanation

You can activate a trigger based on the external signal applied to the EXT TRIG IN terminal on the rear panel of the DL1740E/DL1740EL (or the EXT terminal on the front panel of the DL1720E).

### Note

For detailed specifications of the EXT TRIG IN terminal (or the EXT terminal on the DL1720E), see section 14.1.

### Selecting the Trigger Source

Select Ext.

### Setting the Trigger Level

Selectable range:  $\pm 2$  V (for the DL1740E/DL1740EL)

$\pm 1$  V (when set to the  $\pm 1$  V range on the DL1720E)

$\pm 10$  V (when set to the  $\pm 10$  V range on the DL1720E)

Resolution: 5 mV (for the DL1740E/DL1740EL)

5 mV (when set to the  $\pm 1$  V range on the DL1720E)

50 mV (when set to the  $\pm 10$  V range on the DL1720E)

### Setting the Trigger Slope

You can select how the trigger source is to cross a specified level for activating the trigger from the following three choices.

f: Activated when the trigger source changes from below the trigger level to above the trigger level (rising).

f: Activated when the trigger source changes from above the trigger level to below the trigger level (falling).

f: Activated on either a rising edge or falling edge.

### Setting the Probe Attenuation

Select a probe for the EXT TRIG IN terminal (or the EXT terminal on the DL1720E), input a trigger signal, then select one of the following according to the attenuation of the connected probe.

1:1,10:1

### Setting the Hold Off

See section 6.4, "Setting the Hold Off Time."

## 6.7 Activating Triggers on the Commercial Power Supply (SIMPLE)

### Procedure

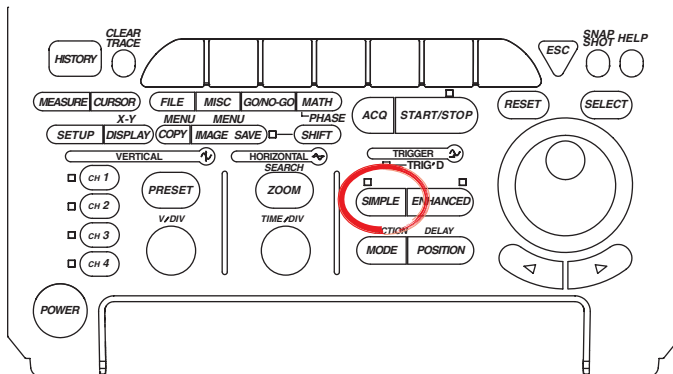

- To exit the menu during operation, press **ESC** located above the soft keys.
- For a description of the operation using a USB keyboard or a USB mouse, see section 4.3.

### Setting the Trigger Source

1. Press **SIMPLE**. The SIMPLE menu appears.
2. Press the **Source** soft key. The Source menu appears.

Source	Level	Slope	Coupling	HF Reject	Hysteresis	Hold Off
CH1	1.50 V	↑	DC	AC	OFF	0.00 (uS)

3. Press the **Line** soft key.  
The CH3 and CH4 soft keys are not displayed on the DL1720E.

CH1	CH2	CH3	CH4	Ext	Line

### Setting the Hold Off

4. Set the hold off time according to the procedures given in section 6.4, "Setting the Hold Off Time."

Source	Level	Slope	Coupling	HF Reject	Hysteresis	Hold Off
Line						0.00 (uS)

### Explanation

This setting is used for activating a trigger on the rising edge of the waveform of the power being supplied to the DL1720E/DL1740E/DL1740EL. Waveforms can be observed by synchronizing to the commercial power supply frequency (50 Hz or 60 Hz).

#### Selecting the Trigger Source

Select Line.

#### Setting the Hold Off

See section 6.4, "Setting the Hold Off Time."

## 6.8 Setting the A->B(N) Trigger (ENHANCED)

<For a description of this function, refer to page 2-8.>

### Procedure

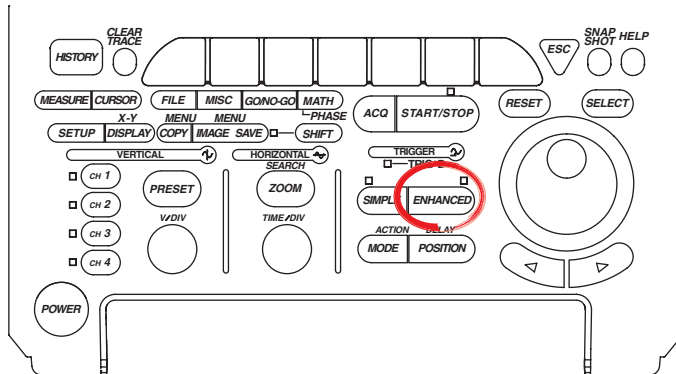

- To exit the menu during operation, press **ESC** located above the soft keys.
- In the procedural explanation below, the term **jog shuttle & SELECT** refers to the operation of selecting/setting items and entering values using the **jog shuttle** and **SELECT** and **RESET** keys. For details on this operation, see sections 4.1 and 4.2.
- For a description of the operation using a USB keyboard or a USB mouse, see section 4.3.

### Setting the Trigger Type

- Press **ENHANCED**. The ENHANCED menu appears.
- Press the **Type** soft key. The Type menu appears.

Type	Set Pattern	Level/ Coupling	Count	ENHANCED Hold Off (uS)
A -> B(N)			1	0.00

- Press the **A->B(N)** soft key.

A -> B(N)	Delay B	Pattern	Width	OR	TV	ENHANCED Hold Off (uS)
						0.00

### Setting the Status and Condition of Condition A and Condition B

- Press the **Set Pattern** soft key. The Set Pattern dialog box opens.  
The settings related to CH3 and CH4 are not displayed on the DL1720E.
- Use **jog shuttle & SELECT** to set the status of condition A of each channel to H, L, or X.
- Use **jog shuttle & SELECT** to set the condition of condition A to Enter or Exit.
- Likewise, set condition B.

Set Pattern		a		b	
CH1		H	L		
CH2		X	H		
CH3		X	X		
CH4		X	X		
Condition		Enter	Exit		

Set the status of condition A/B for each channel to H, L, or X.

Set the Condition of condition A/B to Enter or Exit.

Type	Set Pattern	Level/ Coupling	Count	ENHANCED Hold Off (uS)
a -> B(N)			1	0.00

- Press **ESC**. The Set Pattern dialog box closes.



**Setting the Trigger Level**

9. Press the **Level/Coupling** soft key. The Level/Coupling dialog box opens. The settings related to CH3 and CH4 are not displayed on the DL1720E.

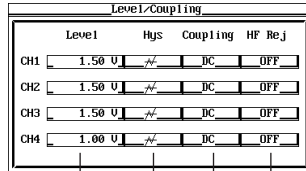
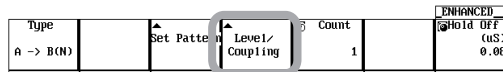

- \*1. Setting the level of each channel
- \*2. Set the hysteresis of each channel to  $\overline{\Delta}$  or  $\overline{\Delta}$ .
- \*3. Set the trigger coupling of each channel to DC or AC.
- \*4. Set the HF rejection of each channel to OFF, 20 MHz, or 15 kHz.

\*1 \*2 \*3 \*4

10. Use **jog shuttle & SELECT** to set the level of each channel.

**Setting the Hysteresis**

11. Use **jog shuttle & SELECT** to set the hysteresis of each channel to  $\overline{\Delta}$  or  $\overline{\Delta}$ .

**Setting the Trigger Coupling**

12. Use **jog shuttle & SELECT** to set the trigger coupling of each channel to DC or AC.

**Setting the HF Rejection**

13. Use **jog shuttle & SELECT** to set the HF rejection of each channel to OFF, 20MHz, or 15kHz.
14. Press **ESC**. The Level/Coupling dialog box closes.

**Setting the Number of Times Condition B Is to Be Met**

15. Press the **Count** soft key.

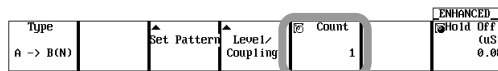

16. Turn the **jog shuttle** to set the count. Pressing RESET resets the value to 1.

**Setting the Hold Off**

17. Set the hold off time according to the procedures given in section 6.4.

**Note**

- The status settings of conditions A and B apply to the A->B(N) trigger and A Delay B trigger.
- The trigger level, hysteresis, trigger coupling, and HF rejection settings apply to both simple and enhanced triggers.

## 6.8 Setting the A->B(N) Trigger (ENHANCED)

---

### Explanation

A trigger is activated the nth time condition B becomes true after condition A has become true.

#### Setting Conditions A and B

- **Status of Each Channel**

You can select from the following three choices.

H: Above the preset trigger level

L: Below the preset trigger level

X: Don't Care

- **Condition**

You can select from the following two choices.

Enter: Trigger is activated when all channels match the specified condition.

Exit: Trigger is activated when any of the channels no longer match the specified condition.

#### Setting the Number of Times Pattern B Is to Be Met

1 to 108 times

#### Setting the Trigger Level

Selectable range: Eight divisions of the screen.

Resolution 0.01 divisions: For example, the resolution for 2 mV/div is 0.02 mV.

#### Setting the Hysteresis

Sets a width to the trigger level so that triggers are not activated by small changes in the trigger signal.

$\overline{\Delta}$ : Approximately 0.3 divisions\* of hysteresis around the trigger level.

$\overline{\Delta}$ : Approximately one division\* of hysteresis around the trigger level.

\* The value above is an approximate value. It is not strictly warranted.

#### Setting the Trigger Coupling

You can select from the following.

AC: Uses a signal that is obtained by removing the DC component from the trigger source signal.

DC: Uses the trigger source signal as-is.

#### Turning the HF Rejection ON and OFF

Specify 15 kHz or 20 MHz if you wish to use a signal that is obtained by removing the high frequency components (frequency components greater than 15 kHz or 20 MHz) from the trigger source signal as the trigger source.

#### Setting the Hold Off

See section 6.4.

#### Note

---

If you wish to activate a trigger on a single pattern condition, use the pattern trigger. If you specify all Xs for the status of condition A or condition B, triggers will not be activated.

---

## 6.9 Setting the A Delay B Trigger (ENHANCED)

<For a description of this function, refer to page 2-9.>

### Procedure

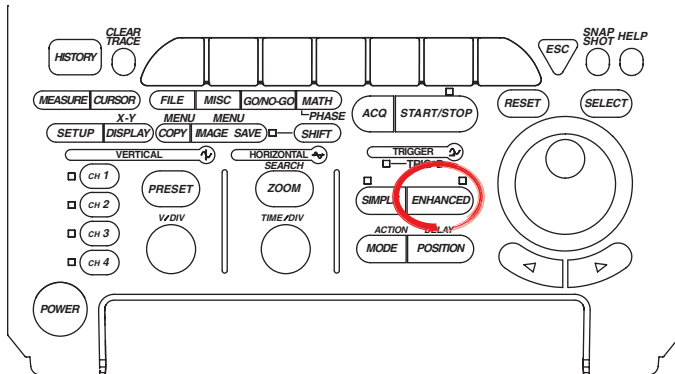

- To exit the menu during operation, press **ESC** located above the soft keys.
- In the procedural explanation below, the term **jog shuttle & SELECT** refers to the operation of selecting/setting items and entering values using the **jog shuttle** and **SELECT** and **RESET** keys. For details on this operation, see sections 4.1 and 4.2.
- For a description of the operation using a USB keyboard or a USB mouse, see section 4.3.

### Setting the Trigger Type

- Press **ENHANCED**. The ENHANCED menu appears.
- Press the **Type** soft key. The Type menu appears.

Type	Set Pattern	Level/ Coupling	Count	ENHANCED Hold OFF (uS)
A -> B(N)			1	0.08

- Press the **A Delay B** soft key.

A -> B(N)	A Delay B	Pattern	Width	OR	TV	ENHANCED Hold OFF (uS)
						0.08

### Setting the Status and Condition of Condition A and Condition B

- Press the **Set Pattern** soft key. The Set Pattern dialog box opens.  
The settings related to CH3 and CH4 are not displayed on the DL1720E.
- Use **jog shuttle & SELECT** to set the status of condition A of each channel to H, L, or X.
- Use **jog shuttle & SELECT** to set the condition of condition A to Enter or Exit.
- Likewise, set condition B.

Set Pattern	
A	B
CH1	H L X
CH2	X H
CH3	X X X
CH4	X X X
Condition	Enter Exit

Set the status of condition A/B for each channel to H, L, or X.

Set the Condition of condition A/B to Enter or Exit.

Type	Set Pattern	Level/ Coupling	Delay(uS)	ENHANCED Hold OFF (uS)
A Delay B			0.003	0.08

- Press **ESC**. The Set Pattern dialog box closes.

## 6.9 Setting the A Delay B Trigger (ENHANCED)

### Setting the Level, Hysteresis, Trigger Coupling, and HF Rejection

9. Press the **Level/Coupling** soft key. The Level/Coupling dialog box opens.  
The settings related to CH3 and CH4 are not displayed on the DL1720E.

Type	▲ Set Pattern	▲ Level/Coupling	Delay(μS)	ENHANCED
A Delay B			0.003	Hold Off(μS) 0.00



Level/Coupling				
	Level	Hys	Coupling	HF Rej
CH1	1.50 V	2V	DC	OFF
CH2	1.50 V	2V	DC	OFF
CH3	1.50 V	2V	DC	OFF
CH4	1.00 V	2V	DC	OFF

\*1 \*2 \*3 \*4

- \*1. Setting the level of each channel
- \*2. Set the hysteresis of each channel to 2V or 2V.
- \*3. Set the trigger coupling of each channel to DC or AC.
- \*4. Set the HF rejection of each channel to OFF, 20 MHz, or 15 kHz.

10. Like in the case of the A->B(N) trigger (see section 6.8), set the level, hysteresis, trigger coupling, and HF rejection.
11. Press **ESC**. The Level/Coupling dialog box closes.

### Setting the Delay

12. Press the **Delay** soft key to set the delay.  
Pressing RESET resets the value to 0.003 μs.

Type	▲ Set Pattern	▲ Level/Coupling	Delay(μS)	ENHANCED
A Delay B			0.003	Hold Off(μS) 0.00

### Setting the Hold Off

13. Set the hold off time according to the procedures given in section 6.4.

### Note

- The status settings of conditions A and B apply to the A->B(N) trigger and A Delay B trigger.
- The trigger level, hysteresis, trigger coupling, and HF rejection settings apply to both simple and enhanced triggers.

**Explanation**

The trigger activates the first time condition B becomes true after condition A has become true and the preset time has elapsed.

**Setting Conditions A and B**

- **Status of Each Channel**

You can select from the following three choices.

H: Above the preset trigger level

L: Below the preset trigger level

X: Don't Care

- **Condition**

Enter: Trigger is activated when all channels match the specified condition.

Exit: Trigger is activated when any of the channels no longer match the specified condition.

**Setting the Delay**

3 ns to 5 s (resolution is 1 ns)

**Setting the Trigger Level**

Selectable range: Eight divisions of the screen.

Resolution 0.01 divisions: For example, the resolution for 2 mV/div is 0.02 mV.

**Setting the Hysteresis**

Sets a width to the trigger level so that triggers are not activated by small changes in the trigger signal.

$\nabla$ : Approximately 0.3 divisions\* of hysteresis around the trigger level.

$\nabla$ : Approximately one division\* of hysteresis around the trigger level.

\* The value above is an approximate value. It is not strictly warranted.

**Setting the Trigger Coupling**

You can select from the following.

AC: Uses a signal that is obtained by removing the DC component from the trigger source signal.

DC: Uses the trigger source signal as-is.

**Turning the HF Rejection ON and OFF**

Specify 15 kHz or 20 MHz if you wish to use a signal that is obtained by removing the high frequency components (frequency components greater than 15 kHz or 20 MHz) from the trigger source signal as the trigger source.

**Setting the Hold Off**

See section 6.4, "Setting the Hold Off Time."

**Note**

If you wish to activate a trigger on only a single pattern condition, use the pattern trigger (see section 6.10). If you specify all Xs for the status of condition A or condition B, triggers will not be activated.

## 6.10 Setting the Pattern Trigger (ENHANCED)

### Procedure

<For a description of this function, refer to page 2-9.>

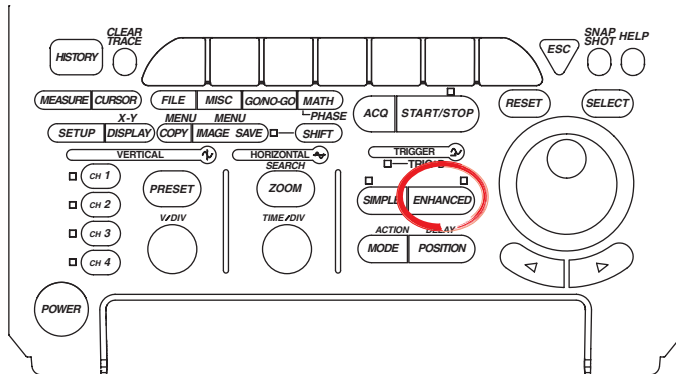

- To exit the menu during operation, press **ESC** located above the soft keys.
- In the procedural explanation below, the term **jog shuttle & SELECT** refers to the operation of selecting/setting items and entering values using the **jog shuttle** and **SELECT** and **RESET** keys. For details on this operation, see sections 4.1 and 4.2.
- For a description of the operation using a USB keyboard or a USB mouse, see section 4.3.

### Setting the Trigger Type

- Press **ENHANCED**. The ENHANCED menu appears.
- Press the **Type** soft key. The Type menu appears.

Type	Set Pattern	Level/ Coupling	Count	1	ENHANCED Hold Off (uS) 0.00
A -> B(N)					

- Press the **Pattern** soft key.

A -> B(N)	A Delay	Pattern	Width	OR	TV	ENHANCED Hold Off (uS) 0.00

### Setting the Status and Condition

- Press the **Set Pattern** soft key. The Set Pattern dialog box opens.  
The settings related to CH3 and CH4 are not displayed on the DL1720E.

Type	Set Pattern	Level/ Coupling			ENHANCED Hold Off (uS) 0.00
Pattern					

- Activating a Trigger Only on the Status Pattern**

- Use **jog shuttle & SELECT** to set Clock CH to None.  
These are not displayed on the DL1720E.
- Use **jog shuttle & SELECT** to select H, L, or X for the status of each channel.
- Use **jog shuttle & SELECT** to set Condition to Enter or Exit.  
Proceed to step 9.

Set Pattern	
Clock CH	None
CH1	H
CH2	H
CH3	L
CH4	X
Condition	Enter

— Select None for the clock channel.  
 — Select H, L, or X for the status of each channel.  
 — Set Condition to Enter or Exit.

• **Activating a Trigger in Synchronization with the Clock Channel**

5. Use **jog shuttle & SELECT** to set Clock CH to CH1 through CH4(2).  
CH3 and CH4 are not displayed on the DL1720E.
6. Use **jog shuttle & SELECT** to set the trigger slope of the clock channel to  $\uparrow$  or  $\downarrow$ .
7. Use **jog shuttle & SELECT** to select H, L, or X for the status of each channel.
8. Use **jog shuttle & SELECT** to set Condition to True or False.

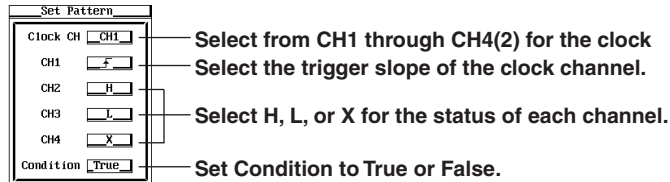

9. Press **ESC**. The Set Pattern dialog box closes.

**Setting the Clock CH Level, Hysteresis, Trigger Coupling, and HF Rejection**

10. Press the **Level/Coupling** soft key. The Level/Coupling dialog box opens.  
The settings related to CH3 and CH4 are not displayed on the DL1720E.

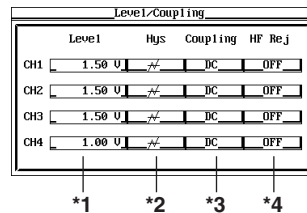

- \*1. Setting the level of each channel
- \*2. Set the hysteresis of each channel to  $\uparrow$  or  $\downarrow$ .
- \*3. Set the trigger coupling of each channel to DC or AC.
- \*4. Set the HF rejection of each channel to OFF, 20 MHz, or 15 kHz.

11. Like in the case of the A->B(N) trigger (see section 6.8), set the level, hysteresis, trigger coupling, and HF rejection.
12. Press **ESC**. The Level/Coupling dialog box closes.

**Setting the Hold Off**

13. Set the hold off time according to the procedures given in section 6.4.

**Note**

The trigger level, hysteresis, trigger coupling, and HF rejection settings apply to both simple and enhanced triggers.

## 6.10 Setting the Pattern Trigger (ENHANCED)

### Explanation

A trigger activates when all the conditions specified on multiple trigger sources are met or not met.

#### Setting the Trigger Source and Status

Select a trigger status of the trigger source from the following three choices.

H: When the trigger source level is above the specified trigger level

L: When the trigger source level is below the specified trigger level

X: Don't use a trigger source

#### Selecting a Clock Channel

- Select None if the trigger is not to be activated in synchronization with the signal.
- To activate the trigger in synchronization with the signal, select a clock channel from CH1 to CH4 (or CH1 to CH2 on the DL1720E).
- You can select a trigger slope from the following.
  - ↗: Rising
  - ↘: Falling

#### Selecting the Trigger Condition

##### • Activating a Trigger Only on the Status Pattern

You can select conditions for activating triggers from the following.

Enter: Activates a trigger when the specified combination (pattern) is met.

Exit: Activates a trigger when the specified pattern is no longer met.

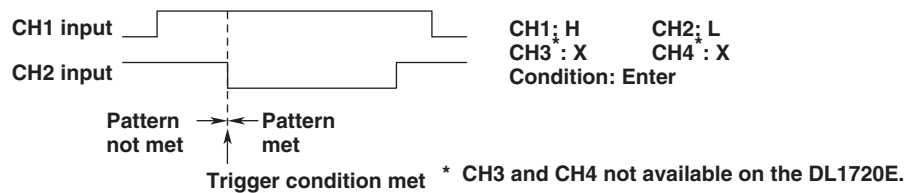

##### • Activating a Trigger in Synchronization with the Clock Channel

You can select conditions for activating triggers from the following.

True: A trigger is activated on the rising or falling edge of the clock channel while the status pattern is met.

False: A trigger is activated on the rising or falling edge of the clock channel while the status pattern is not met.

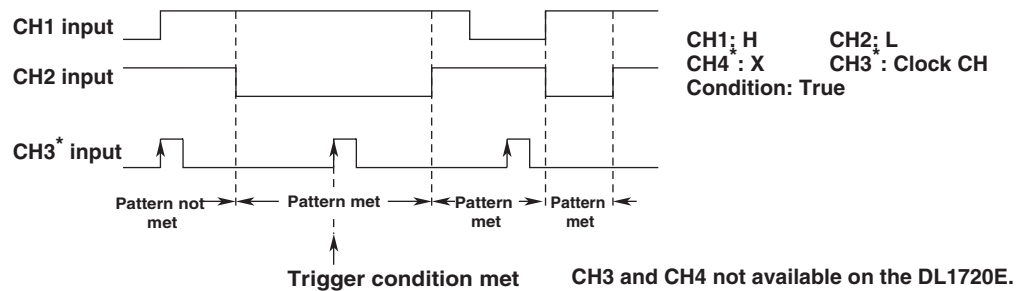



**Setting the Trigger Level**

Selectable range: Eight divisions of the screen.

Resolution: 0.01 divisions: For example, the resolution for 2 mV/div is 0.02 mV.

**Setting the Hysteresis**

Sets a width to the trigger level so that triggers are not activated by small changes in the trigger signal.

$\overline{\Delta}$ : Approximately 0.3 divisions\* of hysteresis around the trigger level.

$\overline{\nabla}$ : Approximately one division\* of hysteresis around the trigger level.

\* The value above is an approximate value. It is not strictly warranted.

**Setting the Trigger Coupling**

You can select from the following.

AC: Uses a signal that is obtained by removing the DC component from the trigger source signal.

DC: Uses the trigger source signal as-is.

**Turning the HF Rejection ON and OFF**

Specify 15 kHz or 20 MHz if you wish to use a signal that is obtained by removing the high frequency components (frequency components greater than 15 kHz or 20 MHz) from the trigger source signal as the trigger source.

**Setting the Hold Off**

See section 6.4, "Setting the Hold Off Time."

**Notes on Setting the Pattern Trigger**

- If you change the trigger type setting, the pattern trigger setting is disabled. However, if the trigger type is set to pattern trigger again, the previous setting is activated.
- The operation is set to auto mode even when the trigger mode is set to auto level mode.  
You can set the trigger status to all trigger sources. On the channel selected to be the clock channel, select the trigger slope.
- When activating a trigger in synchronization with the clock signal, if the setup time of the pattern for the clock signal is 1 ns or more, keep the hold time at 1 ns or more.

## 6.11 Activating a Width (Pulse<T, Pulse>T, T1<PLS<T2, and Time Out) Trigger (ENHANCED)

<For a description of this function, refer to page 2-10.>

### Procedure

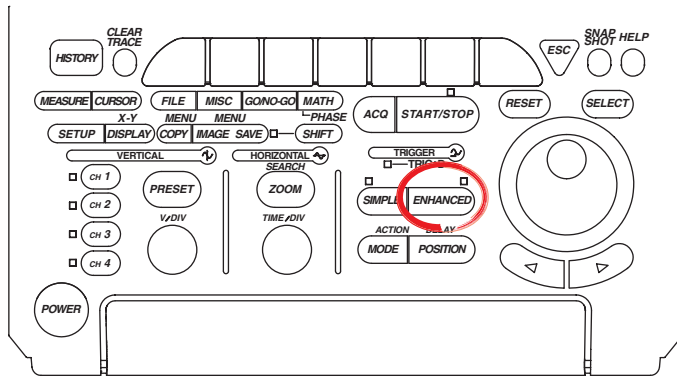

- To exit the menu during operation, press **ESC** located above the soft keys.
- In the procedural explanation below, the term **jog shuttle & SELECT** refers to the operation of selecting/setting items and entering values using the **jog shuttle** and **SELECT** and **RESET** keys. For details on this operation, see sections 4.1 and 4.2.
- For a description of the operation using a USB keyboard or a USB mouse, see section 4.3.

### Setting the Trigger Type

- Press **ENHANCED**. The ENHANCED menu appears.
- Press the **Type** soft key. The Type menu appears.

Type	Set Pattern	Level/ Coupling	Count	1	ENHANCED	Hold OFF (uS)	0.00
A -> B(N)							

- Press the **Width** soft key.

A -> B(N)	A Delay B	Pattern	Width	OR	TU	ENHANCED	Hold OFF (uS)	0.00
-----------	-----------	---------	-------	----	----	----------	---------------	------

### Setting the Width Type

- Press the **Width Type** soft key. The Width Type menu appears.

Type	Width Type	Set Pattern	Level/ Coupling	@Time(uS)	Window	ENHANCED	Hold OFF (uS)	0.00
Width	Pulse<T			0.001	OFF	DN		

- Press the **Pulse<T, Pulse>T, T1<PLS<T2, or Time Out** soft key.

Type	Pulse<T	Pulse>T	T1<PLS<T2	Time Out	Window	ENHANCED	Hold OFF (uS)	0.00
Width					OFF	DN		

### Setting the Window

- Press the **Window** soft key and select ON or OFF.
  - If set to OFF, a trigger is activated on the time width over which the parallel pattern of the status (H, L, or X) of each channel is met or not met.
  - If set to ON, a trigger is activated on the time over which the parallel pattern of the window condition (IN, OUT, or X) of each channel is met or not met.

Type	Width Type	Set Pattern	Level/ Coupling	@Time(uS)	Window	ENHANCED	Hold OFF (uS)	0.00
Width	Pulse<T			0.001	OFF	DN		

## 6.11 Activating a Width (Pulse<T, Pulse>T, T1<PLS<T2, and Time Out) Trigger (ENHANCED)

### Setting the Status

- Press the **Set Pattern** soft key. The Set Pattern dialog box opens.  
The settings related to CH3 and CH4 are not displayed on the DL1720E.

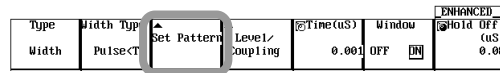

- Use **jog shuttle & SELECT** to set the status of each channel to H, L, or X (IN, OUT, or X if Window is ON).
- Use **jog shuttle & SELECT** to set Condition to True or False.

#### When Window is OFF

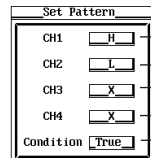

Select H, L, or X for the status of each channel.

Set Condition to True or False.

#### When Window is ON

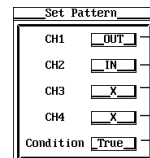

Select IN, OUT, or X for the window condition of each channel.

Set Condition to True or False.

- Press **ESC**. The Set Pattern dialog box closes.

### Setting the Level, Hysteresis, Trigger Coupling, and HF Rejection

- Press the **Level/Coupling** soft key. The Level/Coupling dialog box opens.  
The settings related to CH3 and CH4 are not displayed on the DL1720E.
- Like in the case of the A->B(N) trigger (see section 6.8), set the level, hysteresis, trigger coupling, and HF rejection.  
If Window is ON, set the window position and width, trigger coupling, and HF rejection.  
The setting is the same as the window trigger. See section 6.13.



#### When Window is

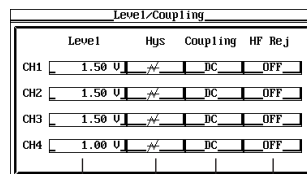

\*1

\*2

\*3

\*4

#### When Window is ON

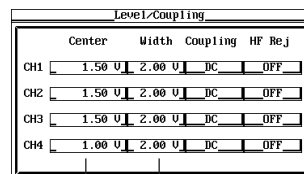

\*5

\*6

- \*1. Setting the level of each channel
- \*2. Set the hysteresis of each channel to  $\nabla$  or  $\nabla$ .
- \*3. Set the trigger coupling of each channel to DC or AC.
- \*4. Set the HF rejection of each channel to OFF, 20 MHz, or 15 kHz.
- \*5. Set the window position of each channel
- \*6. Set the window width of each channel

- Press **ESC**. The Level/Coupling dialog box closes.

### Note

The trigger level, hysteresis, trigger coupling, and HF rejection settings apply to both simple and enhanced triggers.

## 6.11 Activating a Width (Pulse<T, Pulse>T, T1<PLS<T2, and Time Out) Trigger (ENHANCED)

### Setting the Determination Time

14. Press the **Time** soft key.

If Width Type is T1<PLS<T2, press the Time1/Time2 soft key to set the jog shuttle control to Time1 or Time2.

Type	Width Type	Set Pattern	Level/ Coupling	Time (uS)	Window	ENHANCED
Width	Pulse<T			0.001	OFF	ON

When Width Type is T1 < Pulse < T2

15. Turn the **jog shuttle** to set the determination time.

Pressing RESET resets the pulse width to 0.001 μs (0.002 μs for Time2).

### Setting the Hold Off

16. Set the hold off time according to the procedures given in section 6.4.

## Explanation

This setting is for activating a trigger by determining whether the time over which the specified condition is met or not met is shorter or longer than the determination time set in advance.

### Determination Type

**Pulse > T:** A trigger is activated when the time over which the status pattern condition is met becomes longer than the specified determination time and the condition changes.

**Pulse < T:** A trigger is activated when the time over which the status pattern condition is met is shorter than the specified determination time.

**T1<PLS<T2:** A trigger is activated when the time over which the status pattern condition is met is between the two specified determination times.

**Time Out:** A trigger is activated when the time width over which the status pattern condition is met becomes longer than the specified determination times.

The point where the trigger occurs differs between Pulse > T and Time Out as shown in the figure below.

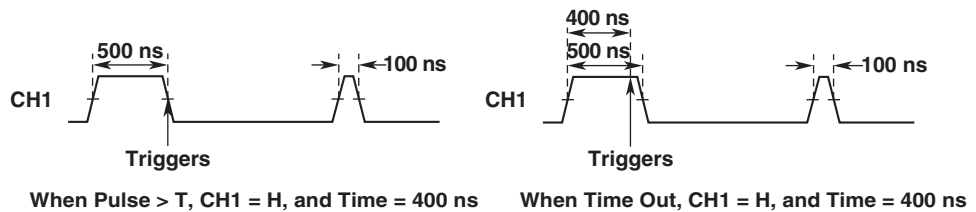

### Example

Pulse<Time, Conditions: CH1 = H, CH2 = H, Other CHs: X,  
When Condition = True, and Time = 400 ns

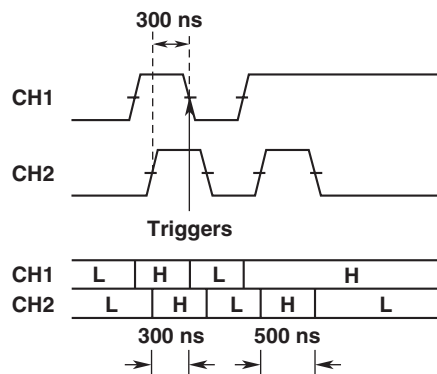

## 6.11 Activating a Width (Pulse<T, Pulse>T, T1<PLS<T2, and Time Out) Trigger (ENHANCED)

### Status of Each Channel

- The status (H, L, and X) is the same as A->B(N) trigger when Window is OFF. See section 6.8.
- The status (IN, OUT, and X) is the same as the window trigger when Window is ON. For a description of window triggers, see section 6.13.

### Setting the Trigger Level

Selectable range: Eight divisions of the screen.

Resolution: 0.01 divisions: For example, the resolution for 2 mV/div is 0.02 mV.

### Setting the Hysteresis

Sets a width to the trigger level so that triggers are not activated by small changes in the trigger signal.

: Approximately 0.3 divisions\* of hysteresis around the trigger level.

: Approximately one division\* of hysteresis around the trigger level.

\* The value above is an approximate value. It is not strictly warranted.

### Setting the Trigger Coupling

You can select from the following.

AC: Uses a signal that is obtained by removing the DC component from the trigger source signal.

DC: Uses the trigger source signal as-is.

### Turning the HF Rejection ON and OFF

Specify 15 kHz or 20 MHz if you wish to use a signal that is obtained by removing the high frequency components (frequency components greater than 15 kHz or 20 MHz) from the trigger source signal as the trigger source.

### Setting the Determination: Time

The selectable range is 1 ns to 1 s, and the resolution is 1 ns.

### Relationship with Window

When Window is turned ON, a trigger is also activated on the time over which the parallel pattern of the window condition (IN, OUT, or X) of each channel is met or not met. For details on the window trigger, see section 6.13, "Setting the Window Trigger."

### Setting the Hold Off

See section 6.4, "Setting the Hold Off Time."

### Notes on Setting the Width Trigger

The trigger may not operate correctly if the interval between pulses or the pulse width of the signal is less than 2 ns. The time accuracy of the pulse width under standard operating conditions after calibration is  $\pm (0.5\% \text{ of setting} + 1 \text{ ns})$ . However, the setting for T1<PLS<T2 is the T2 value.

## 6.12 Setting the OR Trigger (ENHANCED)

### Procedure

<For a description of this function, refer to page 2-10.>

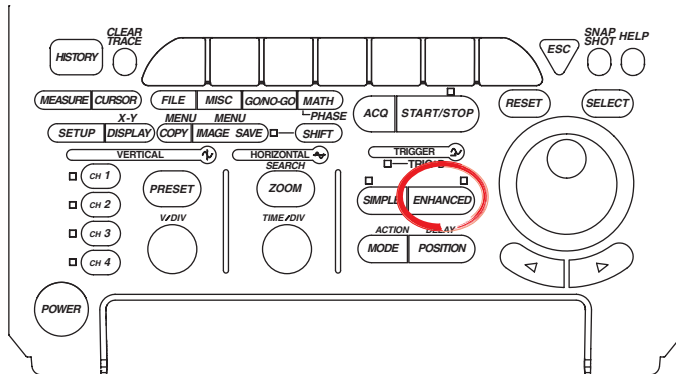

- To exit the menu during operation, press **ESC** located above the soft keys.
- In the procedural explanation below, the term **jog shuttle & SELECT** refers to the operation of selecting/setting items and entering values using the **jog shuttle** and **SELECT** and **RESET** keys. For details on this operation, see sections 4.1 and 4.2.
- For a description of the operation using a USB keyboard or a USB mouse, see section 4.3.

#### Setting the Trigger Type

- Press **ENHANCED**. The ENHANCED menu appears.
- Press the **Type** soft key. The Type menu appears.

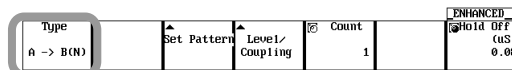

- Press the **OR** soft key.

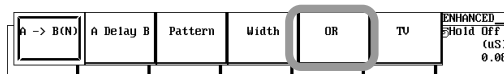

#### Setting the Window

- Press the **Window** soft key and select ON or OFF.
  - If set to OFF, a trigger is activated on the OR logic of the edge of each channel.
  - If set to ON, a trigger is activated on the OR logic of the window condition of each channel.

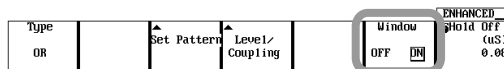

#### Setting Slope of the Edge Trigger of Each Channel

- Press the **Set Pattern** soft key. The Set Pattern dialog box opens. The settings related to CH3 and CH4 are not displayed on the DL1720E.

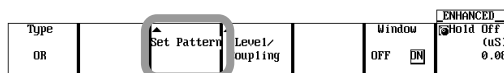

- Use **jog shuttle & SELECT** to set the slope of the edge trigger of each channel to  $\uparrow$ ,  $\downarrow$ , or — (IN, OUT, or — if Window is ON).

#### When Window is OFF

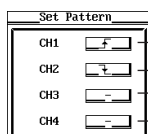

You can select the slope of the edge for each channel.

#### When Window is ON

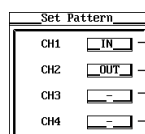

Select IN, OUT, or X for the window condition of each channel.

- Press **ESC**. The Set Pattern dialog box closes.

**Setting the Level, Hysteresis, Trigger Coupling, and HF Rejection**

8. Press the **Level/Coupling** soft key. The Level/Coupling dialog box opens.  
The settings related to CH3 and CH4 are not displayed on the DL1720E.
9. Like in the case of the A->B(N) trigger (see section 6.8), set the level, hysteresis, trigger coupling, and HF rejection.  
If Window is ON, set the window position and width, trigger coupling, and HF rejection.  
The setting is the same as the window trigger. See section 6.13.

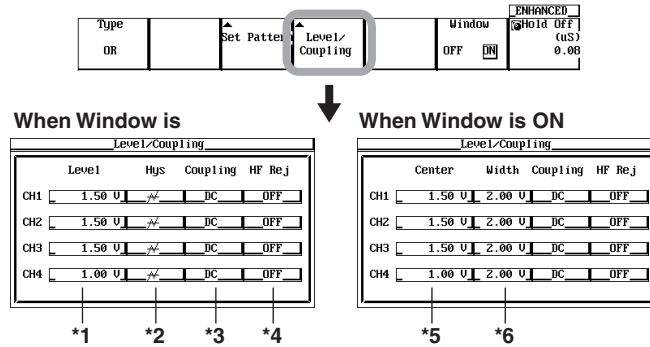

- \*1. Set the level of each channel.
- \*2. Select  $\overline{\text{V}}$  or  $\overline{\text{A}}$  for the hysteresis of each channel.
- \*3. Select DC or AC for the trigger coupling of each channel
- \*4. Select OFF, 200 MHz, or 15 kHz for the HR rejection of each channel.
- \*5. Set the position of the Window for each channel.
- \*6. Set the width of the Window for each channel.

10. Press **ESC**. The Level/Coupling dialog box closes.

**Note**

The trigger level, hysteresis, trigger coupling, and HF rejection settings apply to both simple and enhanced triggers.

**Setting the Hold Off**

11. Set the hold off time according to the procedures given in section 6.4.

### **Explanation**

This setting is for activating a trigger on the OR logic of the edge trigger or the OR logic of the window trigger of each channel.

#### **Setting the Edge Trigger of Each Channel**

f: Rising  
f̄: Falling  
f̄f: Don't Care

#### **Setting the Trigger Level**

Selectable range: Eight divisions of the screen.

Resolution: 0.01 divisions: For example, the resolution for 2 mV/div is 0.02 mV.

#### **Setting the Hysteresis**

Sets a width to the trigger level so that triggers are not activated by small changes in the trigger signal.

$\overline{\Delta}$ : Approximately 0.3 divisions\* of hysteresis around the trigger level.

$\overline{\Delta}$ : Approximately one division\* of hysteresis around the trigger level.

\* The value above is an approximate value. It is not strictly warranted.

#### **Setting the Trigger Coupling**

You can select from the following.

AC: Uses a signal that is obtained by removing the DC component from the trigger source signal.

DC: Uses the trigger source signal as-is.

#### **Turning the HF Rejection ON and OFF**

Specify 15 kHz or 20 MHz if you wish to use a signal that is obtained by removing the high frequency components (frequency components greater than 15 kHz or 20 MHz) from the trigger source signal as the trigger source.

#### **Setting the Hold Off**

See section 6.4, "Setting the Hold Off Time."

#### **Relationship with Window**

When Window is turned ON, a trigger is activated on a Window of OR trigger. For details on window triggers, see section 6.13.



## 6.13 Setting a Window Trigger (ENHANCED)

<For a description of this function, refer to page 2-10.>

### Procedure

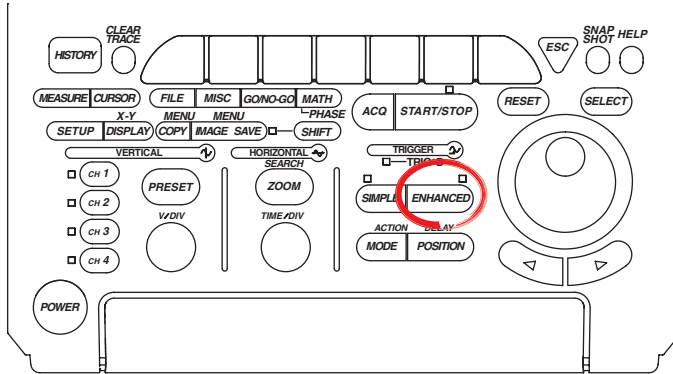

- To exit the menu during operation, press **ESC** located above the soft keys.
- In the procedural explanation below, the term **jog shuttle & SELECT** refers to the operation of selecting/setting items and entering values using the **jog shuttle** and **SELECT** and **RESET** keys. For details on this operation, see sections 4.1 and 4.2.
- For a description of the operation using a USB keyboard or a USB mouse, see section 4.3.

### Setting the Trigger Type

- Press **ENHANCED**. The ENHANCED menu appears.
- Press the **Type** soft key. The Type menu appears.

Type	Set Pattern	Level/ Coupling	Count	ENHANCED Hold OFF (uS)
A -> B(N)			1	0.00

- Press the **Width** or the **OR** soft key.

A -> B(N)	A Delay B	Pattern	Width	OR	TV	ENHANCED Hold OFF (uS)
						0.00

### Setting a Window Trigger

- Press the **Window** soft key to select ON.  
Set the status and trigger condition of each channel according to the procedures given in section 6.11 or 6.12.

Type	Width Type	Set Pattern	Level/ Coupling	Time(uS)	Window	ENHANCED Hold OFF (uS)
Width	PulseCT			0.01	OFF ON	0.00

### Setting the Center Level and Window Width

- Press the **Level/Coupling** soft key. The Level/Coupling dialog box opens.  
The settings related to CH3 and CH4 are not displayed on the DL1720E.
- Use **jog shuttle & SELECT** to set the window center level and the window width.

Type	Width Type	Set Pattern	Level/ Coupling	Time(uS)	Window	ENHANCED Hold OFF (uS)
Width	PulseCT			0.001	OFF ON	0.00

Level/Coupling					
Center	Width	Coupling	HF	Rej	
CH1	1.50 V	2.00 V	DC	OFF	
CH2	1.50 V	2.00 V	DC	OFF	
CH3	1.50 V	2.00 V	DC	OFF	
CH4	1.00 V	2.00 V	DC	OFF	

\*1 \*2

- \*1. Set the window position of each channel
- \*2. Set the window width of each channel

## 6.13 Setting a Window Trigger (ENHANCED)

### Setting the Trigger Coupling and HF Rejection

7. The setup procedure of the trigger coupling and HF rejection is common to the A->B(N) trigger (section 6.8).
8. Press **ESC**. The Level/Coupling dialog box closes.

### Note

The trigger level, hysteresis, trigger coupling, and HF rejection settings apply to both simple and enhanced triggers.

## Explanation

You can set window triggers for the signals input on channels 1 through 4 (or channels 1 and 2 for the DL1720E).

### Selecting the Trigger Conditions

#### • Width Trigger

- IN: The interval over which the trigger source is within a specified width is assumed to be the time over which the condition is met.
- OUT: The interval over which the trigger source is outside a specified width is assumed to be the time over which the condition is met.

#### • OR Trigger

- IN: A trigger is activated when the trigger source enters a specified width.
- OUT: A trigger is activated when the trigger source exits from a specified width.

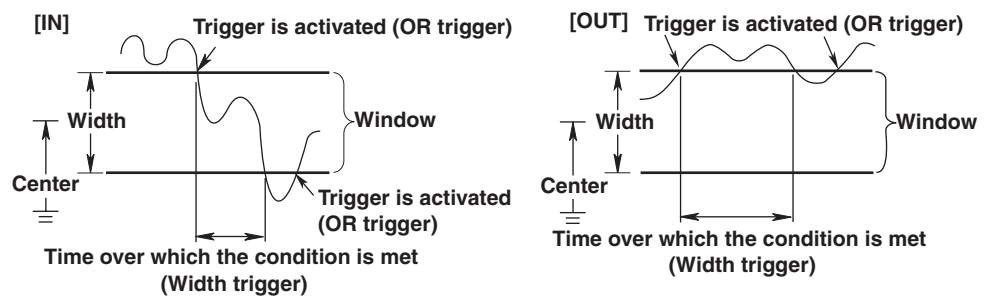

### Setting a Window

A window is defined by its center level and width.

Selectable Range of Center: Eight divisions of the screen (setting resolution of 0.01 div, for example 0.01 V when 1 V/div)

Selectable Range of Width:  $\pm 4$  divisions centered on Level (setting resolution of 0.02 div, for example 0.02 V when 1 V/div)

### Note

The width level can be set above  $\pm 4$  divisions from the center of the screen. However, if either level exceeds the edge of the screen, the operation becomes unstable, so whenever possible the setting should not exceed  $\pm 4$ .

**Setting the Trigger Coupling**

You can select from the following.

AC: Uses a signal that is obtained by removing the DC component from the trigger source signal.

DC: Uses the trigger source signal as-is.

**Turning the HF Rejection ON and OFF**

Specify 15 kHz or 20 MHz if you wish to use a signal that is obtained by removing the high frequency components (frequency components greater than 15 kHz or 20 MHz) from the trigger source signal as the trigger source.

**Setting the Hold Off**

See section 6.4, "Setting the Hold Off Time."

**Relationship between the Width and OR Triggers**

- The trigger types that the window trigger can use are Width and OR.
- To set the window trigger on a single channel, set the window condition of all channels except the channel to be used to – or X.

## 6.14 Setting the TV Trigger (ENHANCED)

<For a description of this function, refer to page 2-11.>

### Procedure

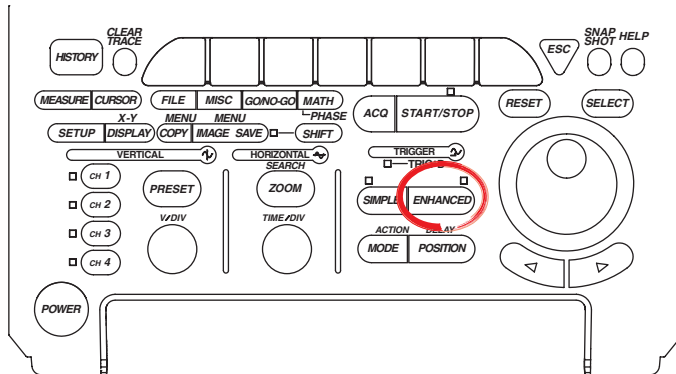

- To exit the menu during operation, press **ESC** located above the soft keys.
- For a description of the operation using a USB keyboard or a USB mouse, see section 4.3.

### Applying a Video Signal

1. Connect the probe (cable) for applying the video signal to the CH1 input terminal.

### Setting the Trigger Type

2. Press **ENHANCED**. The ENHANCED menu appears.
3. Press the **Type** soft key. The Type menu appears.

Type	Set Pattern	Level/Coupling	Count	ENHANCED
A → B(N)			1	Hold Off (uS) 0.00

4. Press the **TV** soft key.

A → B(N)	A Delay B	Pattern	Width	OR	TV	ENHANCED
						Hold Off (uS) 0.00

### Selecting the Broadcasting Type of the Video Signal

5. Press the **TV Type** soft key. The TV Type menu appears.

Type	TV Type	Polarity	Level	Field	Line	ENHANCED
TV	NTSC	Pos	0.5uV	2 X	5	Frame Skip 2 4 8

6. Press the soft key corresponding to the broadcast type of the video signal. The menu contains two pages of selections.

NTSC	PAL	SECAM	1000/60i	1000/50i	720/60p	To Page 2

### Selecting the Polarity

7. Press the **Polarity** soft key to select the polarity.

Type	TV Type	Polarity	Level	Field	Line	ENHANCED
TV	NTSC	Neg	0.5uV	2 X	5	Frame Skip 2 4 8

### Setting the Trigger Level

8. Press the **Level** soft key.
9. Turn the **jog shuttle** to set the trigger level. Pressing **RESET** sets the trigger level to 0.5 divisions or 1.0 division depending on the TV Type (broadcast type).

**Selecting the Field Number**

- 10. Press the **Field** soft key to select the number.  
This value cannot be specified when the TV Type is set to 720/60p, 480/60p, 1080/25p, 1080/24p, or 1080/60p.

**Selecting the Line Number**

- 11. Press the **Line** soft key.
- 12. Turn the **jog shuttle** to set the line number.  
Pressing RESET sets the minimum line setting to 8, 5, or 2 depending on the TV Type setting.

**Selecting Frame Skip**

- 13. Press the **Frame Skip** soft key to select Frame Skip.



**Explanation**

This setting is for activating a trigger on a video signal applied to CH1.

**Broadcast Types That TV Trigger Supports**

You can select the broadcast mode from the following.  
NTSC, PAL, SECAM, 1080/60i, 1080/50i, 720/60p, 480/60p, 1080/25p, 1080/24p, 1080/24sF, and 1080/60p.

**Field Number**

You can select the field number to be detected.

- 1: Detect a field in which the start of the vertical sync pulse and the start of the line is at the same time.
- 2: Detect a field in which the start of the vertical sync pulse is delayed by 1/2 H (H is the horizontal scan interval) of the start of the line.
- X: Detect both.

**Polarity**

You can select Pos (positive) or Neg (negative).

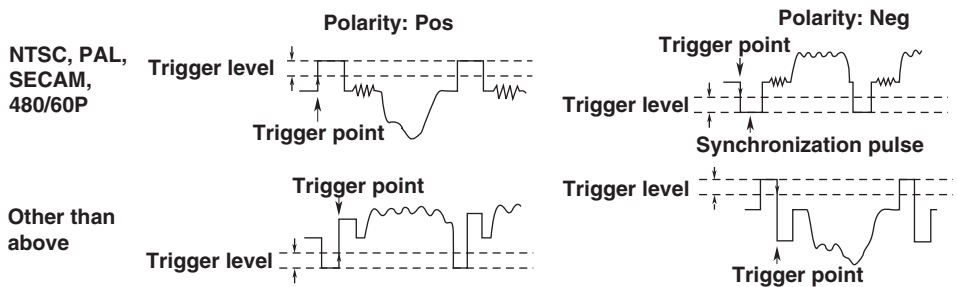

**Trigger Level**

Set the difference between the trigger level and the start value of the sync pulse in units of divisions. The selectable range is 0.1 to 2.0 divisions within the screen. The resolution is 0.01 divisions. By default, the trigger level for NTSC, PAL, and SECAM is 0.5 divisions. For all other broadcasting types, the trigger level is 1.0 division.

## 6.14 Setting the TV Trigger (ENHANCED)

### Line Number

A trigger is activated at the start of the line of the selected number.

- **NTSC: 5 to 1054**

The following line numbers are those when the field number is set to 1 (if the field number is set to 2, the numbers are assigned sequentially by setting 268 to 5).

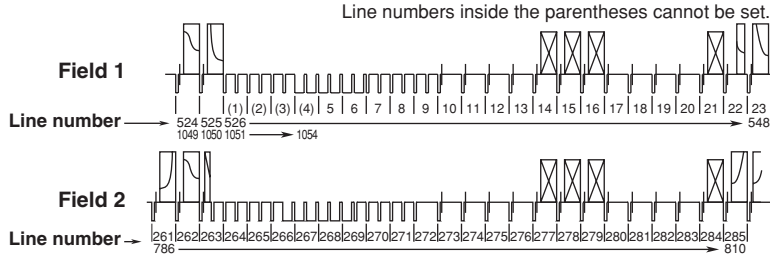

- **For PAL or SECAM: 2 to 1251**

The following line numbers are those when the field number is set to 1 (if the field number is set to 2, the numbers are assigned sequentially by setting 315 to 2).

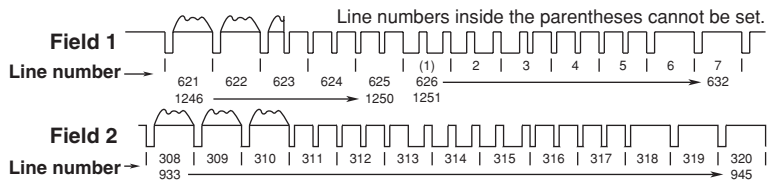

- **For 1080/60i, 1080/50i, or 1080/24sF: 2 to 2251**

The following line numbers are those when the field number is set to 1 (if the field number is set to 2, the numbers are assigned sequentially by setting 565 to 2).

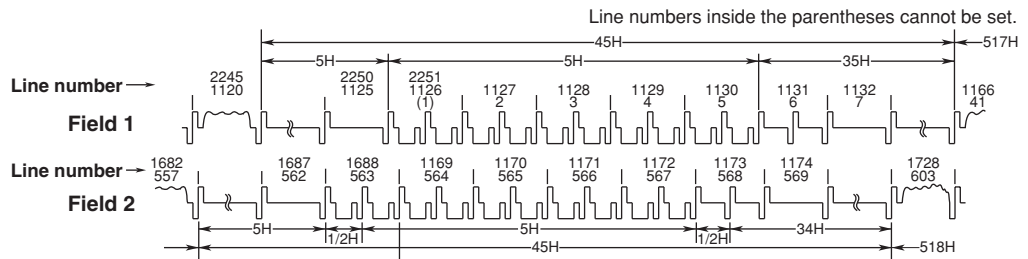

- **For 1080/60p, 1080/25p, or 1080/24p: 2 to 2251**

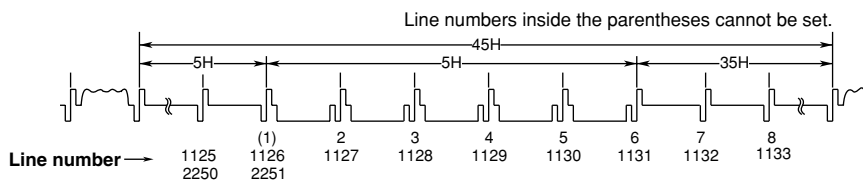

- **For 720/60p: 2 to 2251**

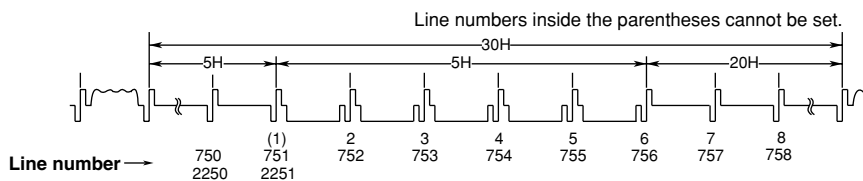

- For 480/60p: 8 to 2251

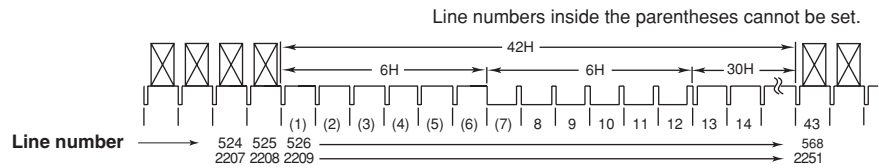

**Frame Skip**

This function is used to skip frames such as when the color burst is inverted every frame. You can select the number of frames at which this operation is repeated.

- 1: Activates a trigger at the specified field every time.
- 2: Skips 1 frames and activates a trigger at the specified field of the succeeding frame. This operation is repeated every two frames.
- 4: Skips three frames and activates a trigger at the specified field of the succeeding frame. This operation is repeated every four frames.
- 8: Skips seven frames and activates a trigger at the specified field of the succeeding frame. This operation is repeated every eight frames.

**Note**

- Video signals can only be input to CH1. All other channels do not support video signals.
- Hold-off, trigger coupling, and HF rejection settings are ignored.

## 6.15 Setting the Action-on-Trigger

<For a description of this function, refer to page 2-13.>

### Procedure

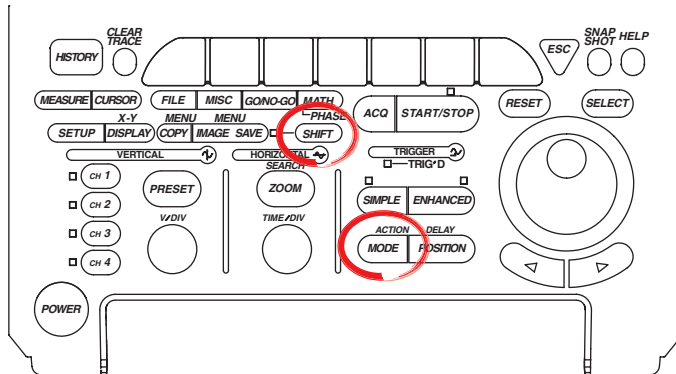

- To exit the menu during operation, press **ESC** located above the soft keys.
- For a description of the operation using a USB keyboard or a USB mouse, see section 4.3.

1. Press **SHIFT+MODE (ACTION)**. The ACTION menu appears.
2. Press the soft key corresponding to the action to be enabled and select **ON**.  
If Send Mail is turned **ON**, use the jog shuttle to set the mail transmission count (MailCount).

Buzzer	Save to File	Hard Copy	Image Save	ACQ Count	Send Mail	ACTION
OFF	ON	OFF	ON	Infinite	OFF	Exec
					MailCount	
					100	

### Setting the Action Count

3. Turn the **jog shuttle** to set the action count (ACQ Count).  
Pressing **RESET** sets the count to Infinite.

### Executing and Canceling the Action Trigger

4. Press the **Exec** soft key. The waveform acquisition starts and action-on-trigger is executed. Exec changes to Abort.

To abort an action-on-trigger, press the **Abort** soft key or **START/STOP**. The waveform acquisition stops and action-on-trigger is aborted.

Buzzer	Save to File	Hard Copy	Image Save	ACQ Count	Send Mail	ACTION
OFF	ON	OFF	ON	Infinite	OFF	Exec
					MailCount	
					100	



**Explanation**

A specified action can be executed each time a trigger is activated.

**Action to Be Performed When the Trigger Condition Is Met:**

Buzzer: Sounds a buzzer.

Save to File: Saves waveform data, measured waveform parameters, and snapshot waveforms to the storage medium (floppy disk, PC card, Net Drive\*, or USB storage) specified in the FILE menu.

Hard Copy: Outputs the screen image data to the printer (Built-in, USB, or Net Print\*) specified under Copy to in the Copy menu.

Image Save: Saves screen image data to the storage medium (floppy disk, PC card, Net Drive\*, or USB storage) specified in the Image Save menu.

Send Mail: Sends Mail\*. Set the mail send count in the range from 1 to 1000. For details, see section 13.5.

\* When the Ethernet interface option is installed

**Note**

When the action-on-trigger is started, the specified action is performed when the trigger is activated in the normal mode regardless of the trigger mode setting.

**Action Count: ACQ Count**

1-65536: Repeats the action the specified number of counts.

Infinite: Repeats the action until waveform acquisition is stopped.

**Operation When Action Set to Save to File, Hard Copy, or Image Save**

The operation follows the settings specified in the FILE, COPY, or Image Save menu.

**File Name When Action Set to Save to File or Image Save**

The file name is automatically assigned by the auto naming function. For details, see section 12.5 or 12.9.

**Operation When Action is Set to Send Mail**

Sends mail to the address specified when choosing MISC key > Network > Mail Setup > Mail Address.

**Trigger Mode**

The trigger mode is set to Single.

**Notes on Setting the Action On Trigger**

- Action-on-trigger cannot be used if the acquisition mode is Average.
- Settings cannot be changed while action-on-trigger is in progress.

## 6.16 Setting the Trigger Gate

### Procedure

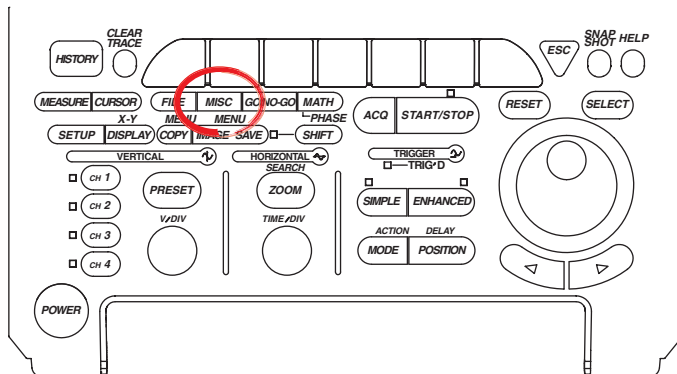

- To exit the menu during operation, press **ESC** located above the soft keys.
- For a description of the operation using a USB keyboard or a USB mouse, see section 4.3.

1. Press the **MISC** key. The MISC menu appears.
2. Press the **System Config** soft key. The System Cnfg menu appears.

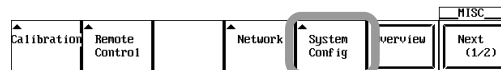

3. Press the **Trigger Gate** soft key to select OFF, Active H, or Active L.

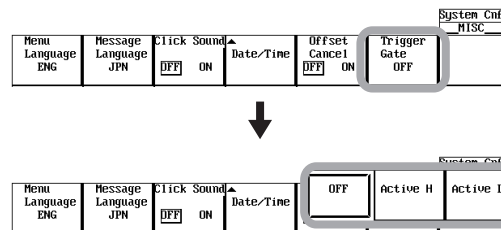

**Explanation****Trigger Gate**

Set the timing when the specified trigger condition is activated.

OFF: When the trigger condition is met, the waveform is acquired.

Active High: When the external signal is low, the waveform is not acquired even when the trigger condition is met. When the trigger condition is met when the external signal is high, the waveform is acquired.

Active Low: When the external signal is high, the waveform is not acquired even when the trigger condition is met. When the trigger condition is met when the external signal is low, the waveform is acquired.

When trigger gate is set to Active, A->B(N) trigger and A delay B trigger cannot be selected.

**Level**

High or Low is determined by referring to the external trigger level. See section 6.6.

An external signal can be alternately applied to the EXT TRIG IN/EXT CLOCK IN /TRIG GATE IN terminal on the rear panel (or front panel on the DL1720E).

**Trigger Gate Input Terminal**

The trigger gate input terminal is also used as an external trigger input terminal. The terminal is used when you wish to activate the trigger using an external signal.

Item	Specification
Connector type	BNC
Maximum input voltage	$\pm 40$ V (DC+ACpeak) or 28 Vrms when the frequency is 10 kHz or
Frequency range	DC to 50 MHz
Input impedance	Approximately 1 M $\Omega$ and approximately 20 pF
Input range	$\pm 2$ V (for the DL1740E/DL1740EL) $\pm 1$ V (when set to the $\pm 1$ V range on the DL1720E) $\pm 10$ V (when set to the $\pm 10$ V range on the DL1720E)
Minimum input amplitude	0.1 Vp-p (for the DL1740E/DL1740EL) 0.1 Vp-p (when set to the $\pm 1$ V range on the DL1720E) 1 Vp-p (when set to the $\pm 10$ V range on the DL1720E)
Minimum pulse width	10 ns or more for high and low

**[Input terminal]**

For the DL1740E/DL1740EL  
(terminal on the rear panel)

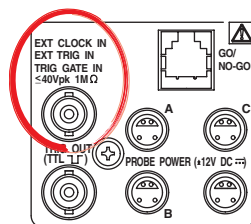

For the DL17420E

(terminal on the front panel)

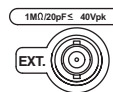
**Note**

The determination level for the trigger gate input and the trigger level for the external trigger input are common.

**CAUTION**

Applying a voltage exceeding the maximum allowable input voltage above can damage the input section.

## 7.1 Starting/Stopping Waveform Acquisition

### Procedure

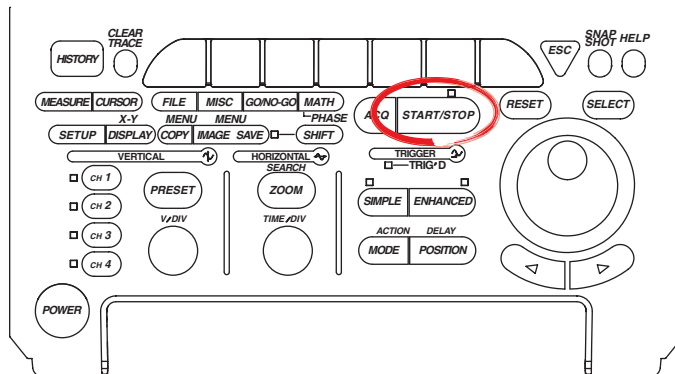

- To exit the menu during operation, press **ESC** located above the soft keys.
- For a description of the operation using a USB keyboard or a USB mouse, see section 4.3.

1. Press **START/STOP**. Waveform acquisition starts or stops.

Waveform acquisition is in progress when the indicator above and to the right of the key is illuminated. When waveform acquisition is stopped, the indicator is OFF and “Stopped” is displayed at the upper left corner of the screen.

### Explanation

When waveform acquisition is started, waveform data is stored to the acquisition memory each time a trigger is activated, and the displayed waveform is updated. The acquisition memory is divided by the specified record length, and the maximum number of waveforms that can be acquired is retained. The past waveforms that have been retained can be recalled and displayed using the history memory function when waveform acquisition is stopped. For the procedure of recalling waveforms using the history memory function, see section 10.1.

#### Operation When the Acquisition Mode Is Set to Averaging Mode

- Averaging is stopped when waveform acquisition is stopped.
- Averaging starts again when waveform acquisition is restarted.

#### START/STOP Operation during Accumulation

Accumulation is aborted when acquisition is stopped.

When waveform acquisition is started, the accumulated waveforms up to that point are cleared, and new accumulation is started.

#### Events that Disable the START/STOP Key

- When remote mode is engaged using the communication interface.
- When printing, during auto setup, and while the storage medium is being accessed.

#### Note

- Pressing the FILE key or HISTORY key while acquiring waveforms stops waveform acquisition.
- If you start waveform acquisition after changing the waveform acquisition conditions, the data that had been stored in the acquisition memory up to that point is cleared.
- A snapshot function that keeps the current displayed waveform on the screen is also available. You can update the display without stopping waveform acquisition (see section 8.6).

## 7.2 Setting the Record Length

<For a description of this function, refer to page 2-14.>

### Procedure

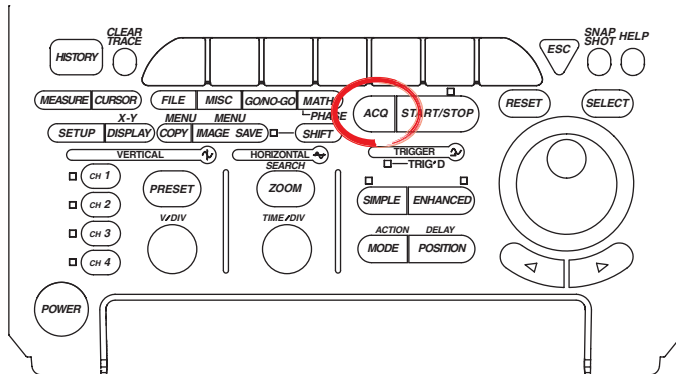

- To exit the menu during operation, press **ESC** located above the soft keys.
- For a description of the operation using a USB keyboard or a USB mouse, see section 4.3.

1. Press **ACQ**. The ACQ menu appears.
2. Press the **Record Length** soft key.

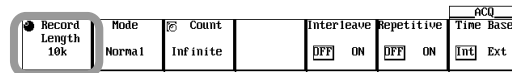

3. Turn the **jog shuttle** to select the record length from 1k to 8M.

### Explanation

You can set the record length (the number of data points) to be stored to the acquisition memory.

The selectable maximum record length varies depending on the model.

DL1720E (1 MWord model)	1 kWord, 10 kWord, 50 kWord, 100 kWord, 250 kWord, 500 kWord (1 MWord)
DL1740E (2 MWord model)	1 kWord, 10 kWord, 50 kWord, 100 kWord, 250 kWord, 500 kWord, 1 MWord, 2 MWord
DL1740EL (8 MWord model)	1 kWord, 10 kWord, 50 kWord, 100 kWord, 250 kWord, 500 kWord, 1 MWord, 2 MWord, 4 MWord, (8 MWord)

The value inside the parentheses is selectable only when interleave mode is ON (see the next section.)

#### Notes on Setting the Record Length

- The sample rate and display record length vary depending on the T/div setting. For more details about this relationship, see appendix 1, "Relationship between the Time Axis, Sample Rate, and Record Length."
- The maximum record length for box average is half the record length of each model indicated above.

## 7.3 Using Interleave Mode

<For a description of this function, refer to page 2-14.>

### Procedure

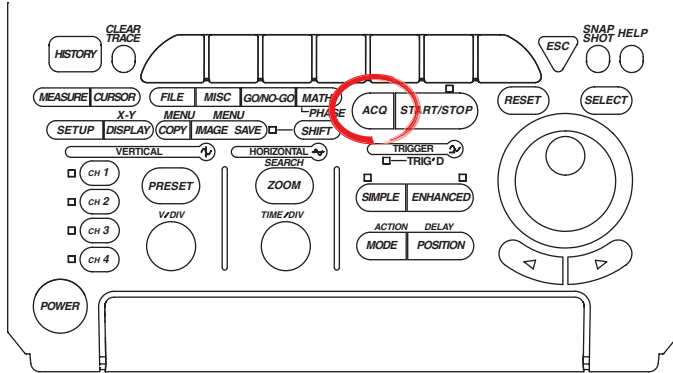

- To exit the menu during operation, press **ESC** located above the soft keys.
- For a description of the operation using a USB keyboard or a USB mouse, see section 4.3.

1. Press **ACQ**. The ACQ menu appears.
2. Press the **Interleave** soft key to select ON or OFF.

Record Length	Mode	Count	Interleave	Repetitive	ACQ Time Base
10k	Normal	Infinite	OFF ON	OFF ON	Int Ext

### Explanation

When interleave mode is turned ON, the number of channels that can be used is limited, but history memory, sequential store count, and record length can be set to twice the normal values. Also, a setting of 1 GS/s becomes available in real time sampling mode. The channels that become unavailable when interleave mode is ON are CH2 and CH4 (or just CH2 on the DL1720E).

For a description of the limitations of the record length, sample rate, and other items when interleave mode is turned ON, see appendix 1.

## 7.4 Turning Repetitive Sampling Mode ON and OFF

<For a description of this function, refer to pages 2-7 and 2-14.>

### Procedure

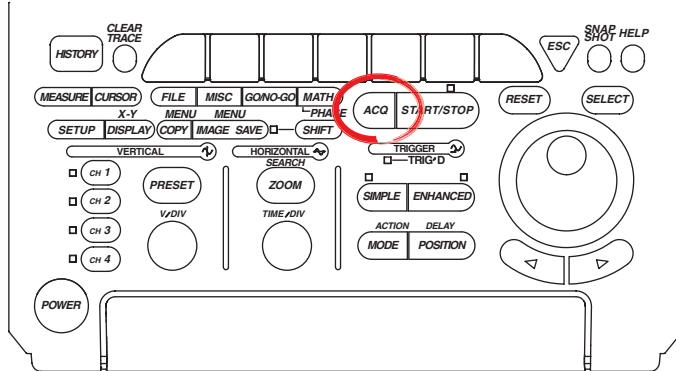

- To exit the menu during operation, press **ESC** located above the soft keys.
- For a description of the operation using a USB keyboard or a USB mouse, see section 4.3.

1. Press **ACQ**. The ACQ menu appears.
2. Press the **Repetitive** soft key to select ON or OFF.

Record Length 10k	Mode Normal	Count Infinite	Interleave OFF	Repetitive ON	ACQ Time Base Ext
----------------------	----------------	-------------------	-------------------	------------------	-------------------------

### Explanation

You can turn repetitive sampling ON or OFF. When repetitive sampling mode is turned ON, the sample rate is set greater than or equal to 1 GS/s (greater than or equal to 2 GS/s when interleave mode is ON) for certain T/div settings. When repetitive sampling is turned OFF, sampling is performed at a rate of up to 500 MS/s (or 1 GS/s when interleave mode is ON). When the number of displayed data points is less than 500, data is interpolated and displayed. However, even when repetitive sampling is turned OFF, repetitive sampling may be performed depending on the time axis setting.

#### Possible T/div Settings for Performing Repetitive Sampling

If repetitive sampling mode is turned ON and the time axis is set according to the table below, repetitive sampling is performed. The T/div settings for performing repetitive sampling vary depending on the specified record length.

Record Length	T/div
1 kWord	1 ns/div to 100 ns/div (1 ns/div to 50 ns/div)
10 kWord	1 ns/div to 1 $\mu$ s/div (1 ns/div to 500 ns/div)
50 kWord	1 ns/div to 5 $\mu$ s/div (1 ns/div to 2 $\mu$ s/div)
100 kWord	1 ns/div to 10 $\mu$ s/div (1 ns/div to 5 $\mu$ s/div)
250 kWord	1 ns/div to 20 $\mu$ s/div (1 ns/div to 10 $\mu$ s/div)
500 kWord	1 ns/div to 50 $\mu$ s/div (1 ns/div to 20 $\mu$ s/div)
1 MWord	1 ns/div to 100 $\mu$ s/div (1 ns/div to 50 $\mu$ s/div)
2 MWord	1 ns/div to 200 $\mu$ s/div (1 ns/div to 100 $\mu$ s/div)
4 MWord	1 ns/div to 500 $\mu$ s/div (1 ns/div to 200 $\mu$ s/div)
8 MWord	-(1 ns/div to 500 $\mu$ s/div)

- The selectable record length varies depending on the model. For details, see section 7.2.
- The values inside the parentheses are the selectable ranges when interleave mode is ON.

#### Notes on Repetitive Sampling

When repetitive sampling is in progress, waveform acquisition using the Single(N) trigger mode is not possible.

# 7.5 Setting the Acquisition Mode

<For a description of this function, refer to page 2-14.>

## Procedure

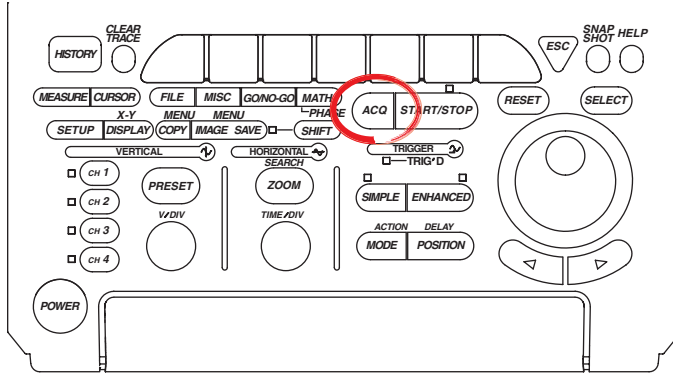

- To exit the menu during operation, press **ESC** located above the soft keys.
- For a description of the operation using a USB keyboard or a USB mouse, see section 4.3.

### Setting the Acquisition Mode

1. Press **ACQ**. The ACQ menu appears.
2. Press the **Mode** soft key. The Mode menu appears.

Record Length	Mode	Count	Interleave	Repetitive	Time Base
10k	Normal	Infinite	OFF	ON	Int Ext

3. Press a soft key to select the acquisition mode.  
You may not be able to select some modes depending on the trigger mode setting (see section 6.1).

Record Length	Mode	Count	Interleave	Repetitive	Time Base
10k	Normal	Infinite	OFF	ON	Int Ext
	Envelope	Average			
	Box Avg				

### Setting the Acquisition Count

4. Press the **Count** soft key.  
Cannot be specified when the trigger mode is Single or Single(N).

Record Length	Mode	Count	Interleave	Repetitive	Time Base
10k	Normal	Infinite	OFF	ON	Int Ext

5. Turn the **jog shuttle** to set the acquisition count.
  - Pressing **RESET** resets the value to Infinite.
  - If the acquisition mode is Average and you set Count to Infinite, proceed to step 6.

### Setting the Attenuation Constant (When the Acquisition Mode Is Average and Count Is Infinite)

6. Press the **Weight** soft key.  
Weight is set as the item under jog shuttle control.

Record Length	Mode	Count	Weight	Interleave	Repetitive	Time Base
10k	Average	Infinite	16	OFF	ON	Int Ext

7. Turn the **jog shuttle** to set the attenuation constant.



**Explanation**

You can select the acquisition mode from the following. The default setting is normal mode.

**Normal Mode (Normal)**

Sampled data is stored in the acquisition memory without special processing.

**When Set to Envelope Mode (Envelope)**

The maximum and minimum values are determined every acquisition interval from the data sampled at 400 MS/s (or 800 MS/s or 1 GS/s when interleave mode is ON). The maximum and minimum values are stored to the acquisition memory and an envelope waveform is displayed.

**Note**

This mode can be specified when the time axis would be 200 MS/s or less in normal mode (or 500 MS/s or less when in interleave mode). For all other cases, the mode is set to normal mode even when envelope mode is specified.

**Averaging Mode (Average)**

Sampled data is averaged and stored to the acquisition memory. The averaging method varies depending on the acquisition count setting.

If set to Infinite, exponential averaging is performed and you must set the attenuation constant (Weight).

If the acquisition count is set to a value in the range of 2 to 65536, simple averaging is performed. The specified value is the average count.

**Exponential averaging (when set to infinite)**      **Simple average (when set to 2 to 65536)**

$$A_n = \frac{1}{N} \{(N-1)A_{n-1} + X_n\}$$

$A_n$  :  $n^{\text{th}}$  averaged value  
 $X_n$  :  $n^{\text{th}}$  measured value

$N$  : Attenuation constant (2 to 256,  $2^n$  steps)

$$A_N = \frac{\sum_{n=1}^N X_n}{N}$$

$X_n$  :  $n^{\text{th}}$  measured value  
 $N$  : Average count

(acquisition count,  $2^n$  steps)

Exponential averaging: Cannot be specified at the same time when in roll mode, or when the trigger mode is Single or Single(N).

Simple averaging: Cannot be specified at the same time when in roll mode or repetitive sampling mode. The maximum record length is 2 MW (4 MW). (The value in parentheses is valid when interleave mode is ON).

For details on the roll mode and repetitive sampling mode, see appendix 1.

**Box Average (Box Avg)**

At sample rates that allow box averaging, data is normally sampled at 400 MS/s (or 1 GS/s or 800 MS/s when interleave mode is ON), and the sampled data is thinned according to the T/div setting and stored to the acquisition memory. When you use the box averaging function, the operation is different. The moving average is computed on a given number of data points, and the result is sampled and stored to the acquisition memory. In this case the internal sample rate is the same as the envelope mode. For details, see appendix 1.

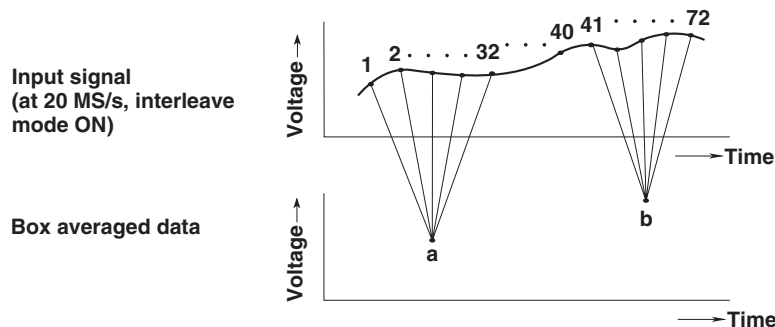

- **Sample Rate and Number of Moving Average Points**

Sample Rate	Number of Moving Average Points	
	When interleave mode is OFF	When interleave is ON
500 MS/s	BoxAverage unavailable	2 points every two points of 1 GS/s
200 MS/s	2 points every 2 points of 400 MS/s	4 points every 4 points of 800 MS/s
100 MS/s	4 points every 4 points of 400 MS/s	8 points every 8 points of 800 MS/s
50 MS/s	8 points every 8 points of 400 MS/s	16 points every 16 points of 800 MS/s
20 MS/s	16 points every 20 points of 400 MS/s	32 points every 40 points of 800 MS/s
10 MS/s	32 points every 40 points of 400 MS/s	64 points every 80 points of 800 MS/s
5 MS/s	64 points every 80 points of 400 MS/s	128 points every 160 points of 800 MS/s
2 MS/s	128 points every 200 points of 400 MS/s	256 points every 400 points of 800 MS/s
1 MS/s	256 points every 400 points of 400 MS/s	256 points every 800 points of 800 MS/s
500 kS/s or less	256 points every 800* points of 400 MS/s	256 points every 1600* points of 800 MS/s

\* The interval at which data is resampled varies depending on the sample rate. However, the maximum number of data points that is box averaged is 256.

- **Possible Record Lengths**

DL1720E: 250 kWords or less (500 kWords or less when in interleave mode)

DL1740E: 500 kWords or less (1 MWords or less when in interleave mode)

DL1740EL: 2 MWords or less (4 MWords or less when in interleave mode)

- **Possible Sample Rates**

The rate can be set at 200 MS/s or less (or 500 MS/s or less when in interleave mode).

If the sample rate exceeds 200 MS/s (or 500 MS/s when in interleave mode), the acquisition mode is set to normal mode even when box average is specified.

### Acquisition Count

You can set the acquisition count. If you set the value to Infinite, acquisition will continue until you press the START/STOP key. The default setting is Infinite. You cannot change the acquisition count while measurement is in progress. Stop the measurement first.

Normal, Envelope, and Box Average: 2 to 65536 (1 step), Infinite

Averaging: 2 to 65536 (2<sup>n</sup> steps), Infinite

### Notes on Averaging

- Averaging is effective only for repetitive waveforms.
- Correct averaging is not possible if the waveform has imperfect triggering (incomplete synchronization), and the displayed waveform will be distorted. When working with this type of signal, set the trigger mode to Normal, so that the waveform display is updated only when the trigger is activated (see section 6.1).
- Roll mode display is disabled when averaging is used.
- If you stop waveform acquisition by pressing the START/STOP key, the averaging process also stops. Averaging restarts from the beginning when acquisition resumes.
- If you are using simple averaging, the instrument terminates acquisition automatically when it completes the specified number of acquisitions (acquisition count).
- When in repetitive sampling mode, only exponential averaging is executed.

## 7.6 Performing Sequential Store (SINGLE(N) Mode)

<For a description of this function, refer to page 2-16.>

### Procedure

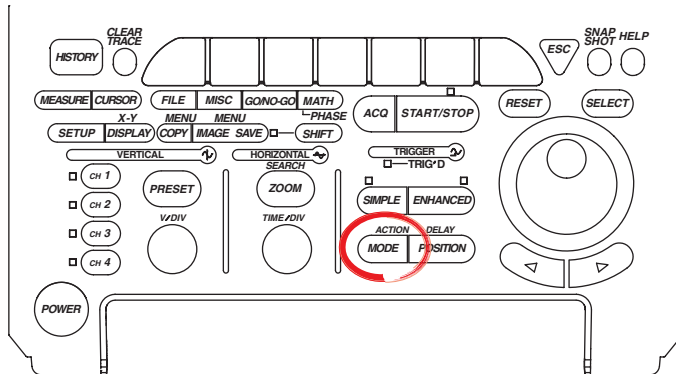

- To exit the menu during operation, press **ESC** located above the soft keys.
- For a description of the operation using a USB keyboard or a USB mouse, see section 4.3.

### Setting the Trigger Mode

1. Press **MODE**. The MODE menu appears.
2. Press the **Single(N)** soft key to set the trigger mode to Single(N).

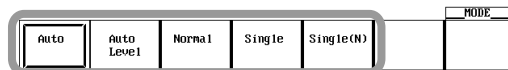

3. Use the **jog shuttle** to set Single(N) Count.

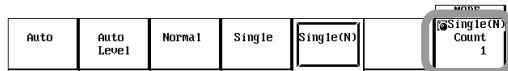

**Explanation**

When the trigger mode is set to Single(N), the sequential store function becomes available.

**Acquisition count: Single(N) Count**

Set in the following range. The acquisition count that can be specified varies depending on the specified record length as follows.

- **For the DL17420E**

Record length	Count When in Normal Mode	Count When in Box Average Mode
1 kWord	1-256 (512)	1-128 (256)
10 kWord	1-32 (64)	1-16 (32)
50 kWord	1-8 (16)	1-4 (8)
100 kWord	1-4 (8)	1-2 (4)
250 kWord	1-2 (4)	1 (2)
1 MWord	1 (2)	- (1)
2 MWord	- (1)	-

The value inside the parentheses is selectable only when interleave mode is ON.

- **For the DL1740E**

Record length	Count When in Normal Mode	Count When in Box Average Mode
1 kWord	1-512 (1024)	1-256 (512)
10 kWord	1-64 (128)	1-32 (64)
50 kWord	1-16 (32)	1-8 (16)
100 kWord	1-8 (16)	1-4 (8)
250 kWord	1-4 (8)	1-2 (4)
1 MWord	1 (2)	- (1)
2 MWord	- (1)	-

The values in parentheses are selectable when interleave mode is ON.

- **For the DL1740EL**

Record length	Count When in Normal Mode	Count When in Box Average Mode
1 kWord	1-1024 (2048)	1-1024 (2048)
10 kWord	1-128 (256)	1-128 (256)
50 kWord	1-32 (64)	1-32 (64)
100 kWord	1-16 (32)	1-16 (32)
250 kWord	1-8 (16)	1-8 (16)
1 MWord	1-2 (4)	1-2 (4)
2 MWord	1 (2)	1 (2)
4 MWord	1 (1)	- (1)
8 MWord	- (1)	-

The values in parentheses are selectable when interleave mode is ON.

**Procedure**

Displayed waveforms can be recalled and displayed in the same manner as with the history memory function. For details, see section 10.1.

**Notes on Performing Sequential Store**

- Sequential store is not possible in repetitive sampling mode and roll mode.
- If you stop acquisition by pressing START/STOP, sequential store also stops. Sequential store starts from the beginning when acquisition resumes.

# 8.1 Changing the Display Format

<For a description of this function, refer to page 2-17.>

## Procedure

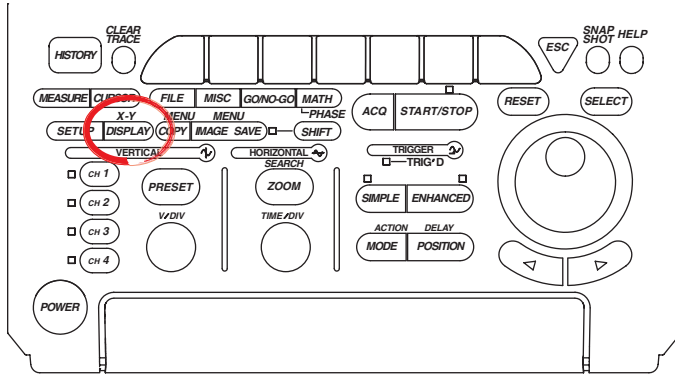

- To exit the menu during operation, press **ESC** located above the soft keys.
- In the procedural explanation below, the term **jog shuttle & SELECT** refers to the operation of selecting/setting items and entering values using the **jog shuttle** and **SELECT** and **RESET** keys. For details on this operation, see sections 4.1 and 4.2.
- For a description of the operation using a USB keyboard or a USB mouse, see section 4.3.

### Setting the Display Format

1. Press **DISPLAY**. The DISPLAY menu appears.
2. Press the **Format** soft key. The Format menu appears.

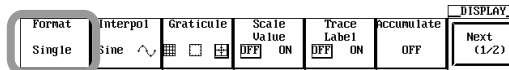

3. Press a soft key from **Single** to **Hexa** to select the display format. Quad and Hexa are not available on the DL1720E.



### Waveform Mapping

4. Press the **Next (1/2)** soft key. The page 2 menu appears.



5. Press the **Mapping** soft key.

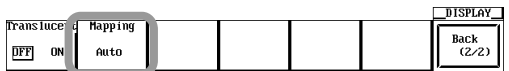

6. Press the **Auto**, **Fixed**, or **User** soft key to select the waveform mapping method.
  - If you select Auto or Fixed, you are done.
  - If you select User, proceed to step 7.



## 8.1 Changing the Display Format

- Press the **Set Mapping** soft key. The Set Mapping dialog box appears.  
The settings related to CH3, CH4, and Math2 are not displayed on the DL1720E.

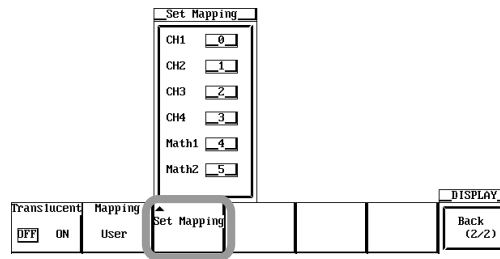

- Use **jog shuttle & SELECT** to set the position number of each channel.

### Explanation

You can choose the number of divisions for the analog waveform display window. The position of the waveform displayed on each channel varies depending on the display format.

#### Display Format: Format

Single: 3 windows

Dual: 2 windows

Triad: 3 windows

Quad: 4 windows (DL1740E/DL1740EL only)

Hexa: 6 windows (DL1740E/DL1740EL only)

#### Waveform Mapping

- Auto\*: The channels CH1, CH2, ..., Math1, Math2 are assigned in order to the split windows starting from the top, with the exception of channels on which display is turned OFF.
- Fixed\*: Channels set not to display are also assigned to channels. Math1 is assigned to the second display frame from the bottom, and Math2 is displayed in the bottom display frame.
- User\*: Numbers 0 to 5 are assigned to CH1, CH2, ..., Math1, and Math2. The display position varies depending on the assigned number.
  - \* CH3, CH4, and Math2 are not available on the DL1720E.

#### Assignment Example When Display Format Is Dual (2 Divisions)

CH1,	CH1, CH4	0, 2, 4
CH2, CH4	CH2,	1, 3, 5
Fixed (when CH3 is OFF)	Auto (when CH3 is OFF)	User

The number of points that can be displayed in the top and bottom eight divisions differs depending on the display format as shown below. The vertical axis resolution does not change.

Single(□): 384 points

Dual(▢): 192 points

Triad(▣): 128 points

Quad(▤): 96 points

Hexa(▥): 64 points

## 8.2 Setting the Display Interpolation Method

<For a description of this function, refer to page 2-17.>

### Procedure

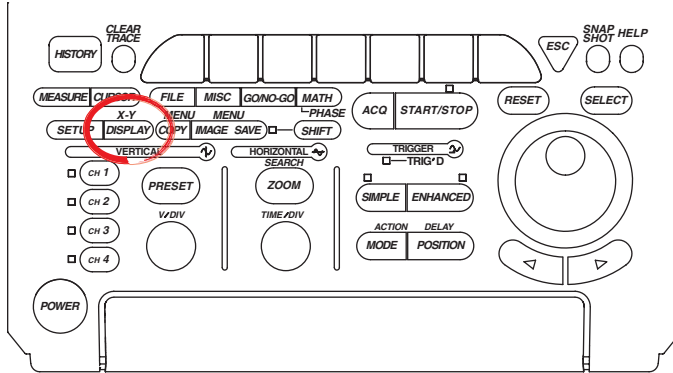

- To exit the menu during operation, press **ESC** located above the soft keys.
- For a description of the operation using a USB keyboard or a USB mouse, see section 4.3.

1. Press **DISPLAY**. The DISPLAY menu appears.
2. Press the **Interpol** soft key. The Interpolation menu appears.

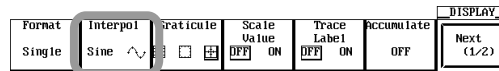

3. Press the **OFF**, **Sine**, **Line**, or **Pulse** soft key to select the interpolation method.

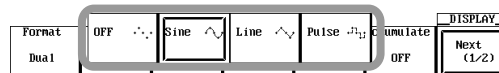

## 8.2 Setting the Display Interpolation Method

### Explanation

#### Interpolation Method

Any area along the time axis having less than 500 points in ten divisions (less than 250 points in the Z1 and Z2 window when displaying Main&Z1&Z2) is recognized as an interpolation area. If you leave interpolation off, these points will appear as discrete dots (so that the display will show gaps between dots or vertical lines).

If you set one of the following interpolation methods, the DL1720E/DL1740E/DL1740EL will connect the points.

Sine(): Interpolates between two points using the sin x/x function.

Line(): Linearly interpolates between two points.

Pulse(): Interpolates between the two points by drawing a horizontal line to the time axis position of the next date point, then connects the end of the horizontal line to the next data point with a vertical line.

OFF(): Interpolation is not performed.

- **When the Area Is Not an Interpolation Area**

As shown in the figure below, if the interpolation method is set to Sine, Line, or Pulse, the instrument draws lines between points that are aligned on the voltage axis.

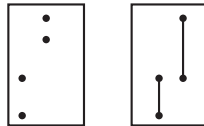

Interpol:    OFF            Sine/Line/Pulse

- **When the Area Is an Interpolation Area**

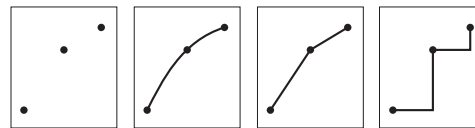

Interpol:    OFF            Sine            Line            Pulse



## 8.3 Accumulating Waveforms

<For a description of this function, refer to page 2-18.>

### Procedure

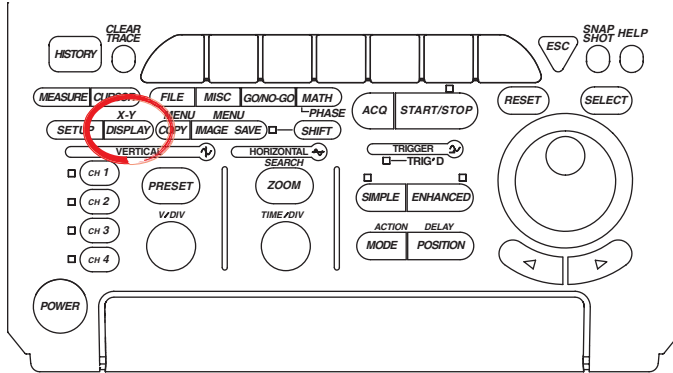

- To exit the menu during operation, press **ESC** located above the soft keys.
- For a description of the operation using a USB keyboard or a USB mouse, see section 4.3.

### Settings for Accumulate Mode

1. Press **DISPLAY**. The DISPLAY menu appears.
2. Press the **Accumulate** soft key. The Accumulate menu appears.

Format	Interpol	Graticule	Scale Value	Trace Label	ACCUMULATE	DISPLAY
Single	Sine		OFF ON	OFF ON	OFF	Next (1/2)

3. Press the **OFF**, **Persist**, or **Color** soft key.  
If you select Persist or Color, skip to step 4 or 5, respectively.

Format	Interpol	Graticule	Scale Value	OFF	Persist	Color
Single	Sine		OFF ON			

### Setting the Accumulation Time (When Persist Mode Is Selected)

4. Turn the **jog shuttle** to set the accumulation time.

Format	Interpol	Graticule	Scale Value	Trace Label	ACCUMULATE	DISPLAY
Single	Sine		OFF ON	OFF ON	Persist Time 100ms	Next (1/2)

### Setting the Grade Width (When Color Mode Is Selected)

5. Turn the **jog shuttle** to set the grade width.

Format	Interpol	Graticule	Scale Value	Trace Label	ACCUMULATE	DISPLAY
Single	Sine		OFF ON	OFF ON	Color Grade 16	Next (1/2)

**Explanation**

Normally, the display is updated every time a trigger is activated making it difficult to capture transient conditions such as sudden distortion of waveforms. By using the accumulate function, the waveform display of the acquired data remains on the screen for the specified time.

**Accumulate Mode**

**Persist:** Persistence mode. Accumulates waveforms using each channel color. The intensity is gradually reduced, and the waveform disappears after the specified accumulation time.

**Color:** Color grade mode. Accumulates waveforms using eight colors indicating data frequency information.

**Setting the Accumulation Time (When in Persist Mode)**

In persistence mode, you can select the time until the waveform disappears from the following. If you select Infinite, the waveform does not disappear. The default setting is 100 ms.

100ms, 200ms, 500ms, 1s, 2s, 5s, 10s, 20s, 50s, Infinite

**Grade Width (When in Color Mode)**

When in color grade mode, the frequency of the data is distinguished using eight colors as shown in the following figure. You can set the boundary value (width) of the colors from the following. The default setting is 16.

Note that when in color grade mode, data is superimposed indefinitely.

2 to 2048 (2<sup>n</sup> steps)

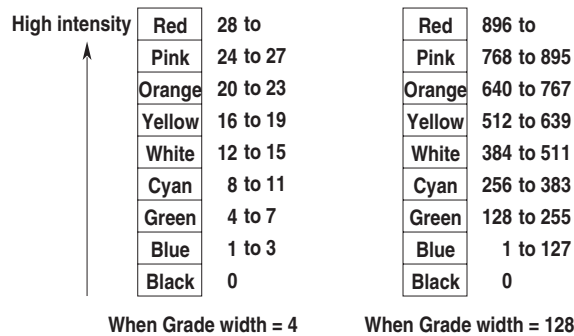

For example, the point (dot) that is drawn one hundred times on the screen as a result of accumulation is red when the grade width is 4 and blue when the grade width is 128.

**Notes on Accumulating Waveforms**

- Automated measurement of waveform parameters and GO/NO-GO determination are executed on the most recent waveform.
- If all the history waveforms are displayed when accumulation is in progress, all the history waveforms are displayed using the specified accumulate mode. However, the waveform display is slowed down.
- The built-in printer (optional) prints accumulated waveforms using two tones.
- On an external printer, only the newest waveform is printed.
- If waveform acquisition is stopped by pressing the START/STOP key, accumulation is aborted. When waveform acquisition is restarted, the displayed waveforms are cleared, and new accumulation is started.

**Clearing Accumulated Waveforms**

You can clear accumulated waveforms by pressing the CLEAR TRACE key.

## 8.4 Zooming the Waveform

<For a description of this function, refer to page 2-18.>

### Procedure

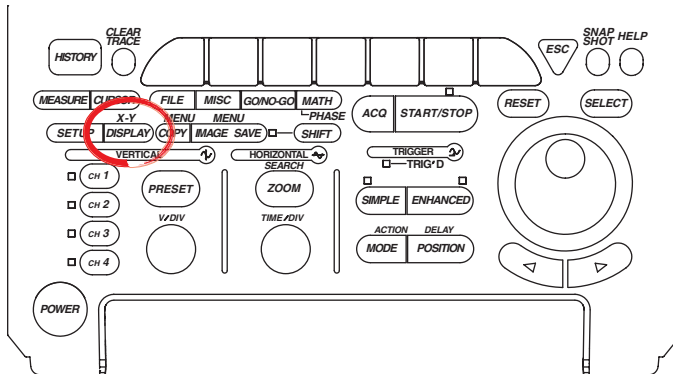

- To exit the menu during operation, press **ESC** located above the soft keys.
- In the procedural explanation below, the term **jog shuttle & SELECT** refers to the operation of selecting/setting items and entering values using the **jog shuttle** and **SELECT** and **RESET** keys. For details on this operation, see sections 4.1 and 4.2.
- For a description of the operation using a USB keyboard or a USB mouse, see section 4.3.

### Selecting the Display Mode

1. Press **ZOOM**. The ZOOM menu appears.
2. Press the **Mode** soft key. The Mode menu appears.

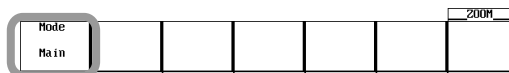

3. Press any soft key from **Main** to **Main&Z1&Z2** to select the display method. If you select Main, the procedure is complete.



### Setting the Display Format

4. Press the **Format** soft key. The Format menu appears. If you set Mode to Main, the Format menu does not appear.

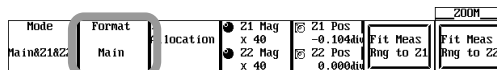

5. Press a soft key from **Main** to **Hexa** to select the display format. Quad and Hexa are not available on the DL1720E.

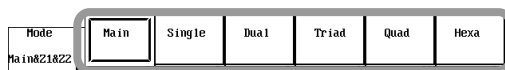

## 8.4 Zooming the Waveform

### Setting the Waveform to Be Zoomed

- Press the **Allocation** soft key. The Allocation dialog box appears.  
CH3, CH4, and Math2 are not displayed on the DL1720E.

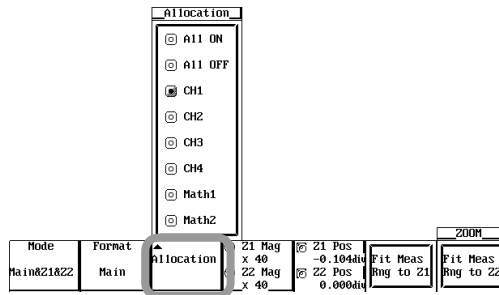

- Use **jog shuttle & SELECT** to select the waveform to be zoomed.
  - If All ON is executed using jog shuttle & SELECT, all the waveforms currently displayed are selected.
  - If All OFF is executed using jog shuttle & SELECT, all the waveforms are deselected.

### Setting the Zoom Factor

- Press the **Z1 Mag/Z2 Mag** soft key to set the jog shuttle control to Z1 Mag.  
If you select Z1 on the Mode menu, Z1 Mag is displayed. If you select Z2, Z2 Mag is displayed. If you select Z1 and Z2, Z1 Mag/Z2 Mag is displayed.
- Turn the **jog shuttle** to set the zoom rate of zoom box Z1.

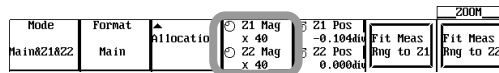

- Likewise, set the zoom rate of zoom box Z2 with Z2 Mag.
  - If you select Z1 Mag, you can set the zoom rate of Z1.
  - If you select Z2 Mag, you can set the zoom rate of Z2.
  - If you select both Z1 Mag and Z2 Mag, the zoom rate of Z2 is set equal to Z1. When you turn the jog shuttle, both are set to the same zoom rate.

### Setting the Zoom Position

- Press the **Z1 Pos/Z2 Pos** soft key to set the jog shuttle control to Z1 Pos.  
If you select Z1 on the Mode menu, Z1 Pos is displayed. If you select Z2, Z2 Pos is displayed. If you select Z1 and Z2, Z1 Pos/Z2 Pos is displayed.
- Turn the **jog shuttle** to set the zoom position of zoom box Z1.

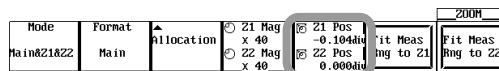

- Likewise, set the zoom position of zoom box Z2 with Z2 Pos.
  - If you select Z1 Pos, you can set the zoom position of Z1.
  - If you select Z2 Pos, you can set the zoom position of Z2.
  - If you select both Z1 Pos and Z2 Pos, the zoom position of Z2 is set equal to Z1. When you turn the jog shuttle, both are set to the same zoom position.

### Changing Automated Measurement of Waveform Parameters

- Press the **Fit Meas Rng to Z1** or **Fit Meas Rng to Z2** soft key.  
The range of the automated measurement of waveform parameters is set to the zoom range of Z1 or Z2.

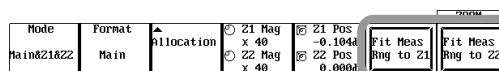

**Explanation**

Zoomed waveforms of two locations can be displayed simultaneously (dual zoom). You can also specify which channels to zoom.

Zoom is possible until the number of displayed points is 50 or less (or 40 or less depending on the time axis setting).

**Selecting the Display Method for Zoomed Waveforms: Mode**

Main:	Displays only the main (unzoomed) waveform.
Z1 Only:	Displays only the zoomed waveform of zoom box Z1.
Z2 Only:	Displays only the zoomed waveform of zoom box Z2.
Main&Z1:	Displays the main waveform in the top window and zoomed waveform of zoom box Z1 in the bottom window.
Main&Z2:	Displays the main waveform in the top window and zoomed waveform of zoom box Z2 in the bottom window.
Z1&Z2:	Displays the zoomed waveform of zoom box Z1 in the top window and the zoomed waveform of zoom box Z2 in the bottom window.
Main&Z1&Z2:	Displays the main waveform in the top window, the zoomed waveform of zoom box Z1 in the lower left window and the zoomed waveform of zoom box Z2 in the lower right window.

**Selecting the Waveform to Be Zoomed: Allocation**

Waveforms whose Allocation had been turned ON (CH1 to CH4, Math1, Math2 (or CH1 and CH2, Math1 on the DL1720E) are zoomed. Waveforms whose Allocation had been turned OFF are not zoomed. You cannot zoom waveforms whose display is turned OFF.

**Display Format of Zoomed Waveforms: Format**

Like the main waveform, six types (Main1, Single, Dual, Triad, Quad, Hexa2) of display formats are available. You cannot set different formats for Z1 and Z2.

1. If you select Main, the format is the same as that of the Main Format setting under the DISPLAY menu.
2. Quad and Hexa are available only on the DL1740E/DL1740EL.

**Zoom Rate: Z1 Mag/Z2 Mag**

- The upper limit of the zoom rate is determined from the display record length as follows:  
Upper limit of zoom rate: display record length ÷ 50 (or 40)  
The display record length does not necessarily match the record length.  
For details on the display record length, see appendix 1.
- You can set different zoom rates for Z1 and Z2 (zoomed waveform of two locations).

**Zoom Position: Z1Pos, Z2Pos**

- The zoom position can be set by specifying the zoom center position (center of the zoom box) in the range of -5 to +5 divisions with the center of the waveform display frame set to 0 divisions. The setting steps are as follows:  
Setting steps of the zoom position =  $T/\text{div} \times 10 \div \text{display record length}$
- The zoom box enclosed by solid lines is Z1 and the one enclosed by dashed lines is Z2. Since each box is independent, you can set the position separately.

**Changing Automated Measurement of Waveform Parameters: Fit Meas Rng to Z1/  
Fit Meas Rng to Z2**

Sets the measurement range of the automated measurement of waveform parameters to the zoom range of Z1 or Z2. This setting is active even when the automated measurement of waveform parameters is turned OFF.

# 8.5 Displaying the X-Y Waveform

<For a description of this function, refer to page 2-19.>

## Procedure

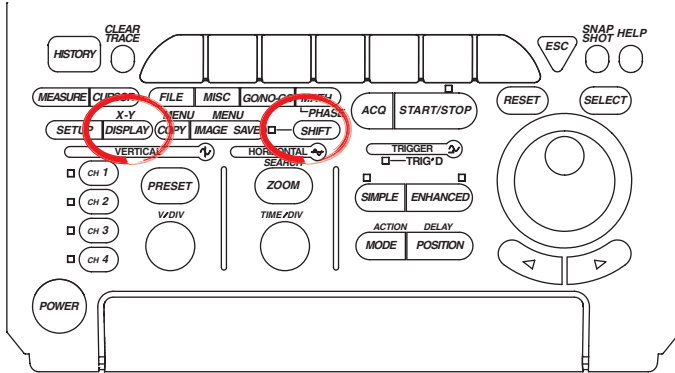

- To exit the menu during operation, press **ESC** located above the soft keys.
- For a description of the operation using a USB keyboard or a USB mouse, see section 4.3.

You can select the display mode.

1. Press **SHIFT+DISPLAY(X-Y)**.
2. Press the **Mode** soft key. The Mode menu appears.

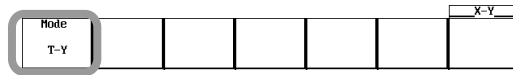

3. Press the **T-Y**, **X-Y**, or **T-Y&X-Y** soft key to select the mode.

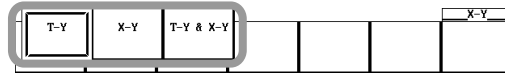

Steps 4 to 11 are necessary only when X-Y or T-Y&X-Y is selected.

### Selecting the X-Axis Mode (Applies to the DL1740E/DL1740EL)

4. Press the **X Axis** soft key to select Single or Dual.

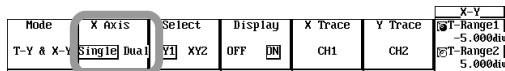

### Selecting the X-Y Waveform (Applies to the DL1740E/DL1740EL)

5. Press the **Select** soft key to select the X-Y waveform to be set.
6. Press the **Display** soft key to turn ON/OFF the X-Y waveform display.



**Setting the X-Axis and Y-Axis**

7. Press the **X Trace** soft key. The X Trace menu appears.
8. Select the waveform to be assigned to the X-axis.  
The CH3, CH4, and Math2 soft keys are not displayed on the DL1720E.

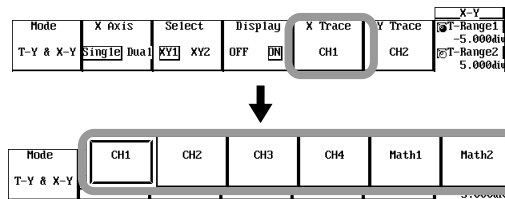

9. Press the **Y Trace** soft key. The Y Trace menu appears.
10. Select the waveform to be assigned to the Y-axis.

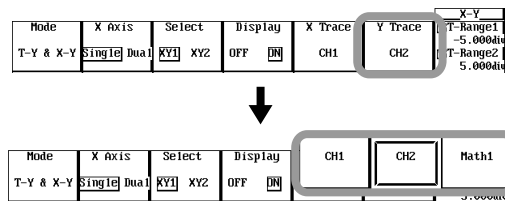
**Setting the Display Range**

11. Press the **T-Range1/T-Range2** soft key to set the jog shuttle control to T-Range1, T-Range2, or both T-Range1 and T-Range2.
  - If you select T-Range1, you can set the start point of the X-Y waveform display.
  - If you select T-Range2, you can set the end point of the X-Y waveform display.
  - If you select both T-Range1 and T-Range2, you can move the start and end points of the X-Y waveform display without changing the spacing between the two. The value of the digit being specified by T-Range1 changes.

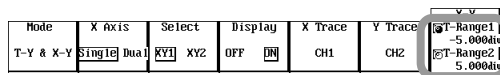

12. Turn the **jog shuttle** to set the start and end points of the X-Y waveform display.

**Explanation**

**Display Mode**

You can select one of the following three display modes.

T-Y&X-Y: The top window displays T-Y (normal) waveforms. The bottom window displays X-Y waveforms.

X-Y: Displays only X-Y waveforms.

T-Y: Displays only T-Y waveforms.

**Selecting the X-Axis Mode: X-Axis (Applies to the DL1740)**

Single: Sets the X-axis trace of XY1 and XY2 common.

Dual: Sets the X-axis trace of XY1 and XY2 separately.

**Number of X-Y Waveforms That Can Be Displayed**

The number of X-Y waveforms that can be displayed is 2 (XY1 on the DL1720E). The display of each X-Y waveform can be turned ON/OFF.

**Assigning the X-Axis (Horizontal Axis) and Y-Axis (Vertical Axis)**

The channels that can be assigned to the X and Y axes depending on the X-axis mode are as follows:

• **For the DL1740E/DL1740EL**

X Axis Mode	X-Y Waveform	X-Axis	Y-Axis
Single	XY1	CH1-CH4, Math1, Math2	CH1, CH2, Math1
	XY2	CH1-CH4, Math1, Math2	CH3, CH4, Math2
Dual	XY1	CH1, CH2, Math1	CH1, CH2, Math1
	XY2	CH3, CH4, Math2	CH3, CH4, Math2

• **For the DL17420E**

X Axis Mode	X-Y Waveform	X-Axis	Y-Axis
-	XY1	CH1, CH2, Math1	CH1, CH2, Math1

**Selecting the X-Y Waveform Display Range: T-Range1/T-Range2**

The X-Y waveform displays the range specified on the T-Y waveform.

You can set the start (fine dashed line) and end (coarse dashed line) positions in the range of -5 to +5 divisions from the center of the waveform display frame. The start and end positions are not displayed if only X-Y waveforms are displayed.

The setting resolution is 10 div ÷ display record length.

**Notes on Displaying X-Y Waveforms**

- The divided windows of the T-Y waveform display when using the T-Y & X-Y mode are displayed according to Format in the DISPLAY menu.
- The zoom function applies only to T-Y waveforms. In addition, Main, Z1, or Z2 can be selected for the T-Y waveform display.
- To expand the X-Y waveform, change the Variable setting of each channel. The displayed waveform can be enlarged/reduced in a simulated fashion.



## 8.6 Taking Snapshots and Clearing Traces

<For a description of this function, refer to page 2-19.>

### Procedure

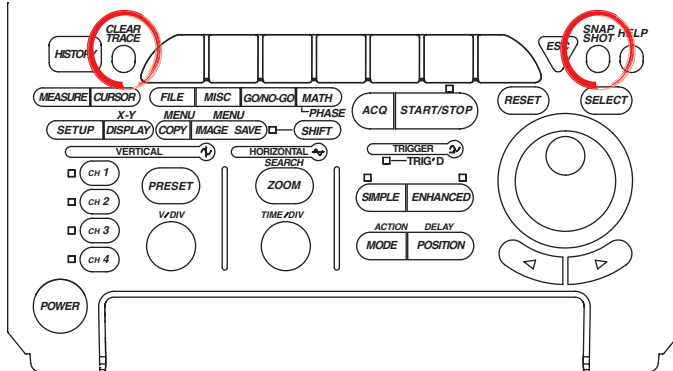

- To exit the menu during operation, press **ESC** located above the soft keys.
- For a description of the operation using a USB keyboard or a USB mouse, see section 4.3.

### Snapshot

Press **SNAP SHOT** to take a snapshot of the screen.

### Clearing Traces

Press **CLEAR TRACE** to clear the waveform.

### Note

Pressing the SHIFT key followed by the SNAP SHOT key clears only the snapshot waveforms.

### Explanation

#### Snapshot

The snapshot function leaves the currently displayed waveform on the screen. You can update the display without stopping the waveform acquisition. This function is useful in situations such as when you wish to compare waveforms.

- You cannot perform the following operations on snapshot waveforms.
  - Cursor measurements
  - Automated measurement of waveform parameters
  - Zoom
  - Computation
- Snapshot waveforms can be saved and loaded. For details, see section 12.7.

#### Clearing Traces

- You can clear all the waveforms that are currently displayed on the screen.
- If you execute CLEAR TRACE when waveforms are being acquired, waveform acquisition is restarted (from the first acquisition).
- Loaded waveforms are not cleared. To clear loaded waveforms, perform an unload operation.

#### Events That Disable the SNAP SHOT and CLEAR TRACE Keys

- When remote mode is engaged using the communication function.
- When printing, during auto setup, and while the storage medium is being accessed.
- When GO/NO-GO determination, action-on-trigger, or waveform search is in progress.

# 8.7 Changing the Graticule (Scale)

<For a description of this function, refer to page 2-20.>

## Procedure

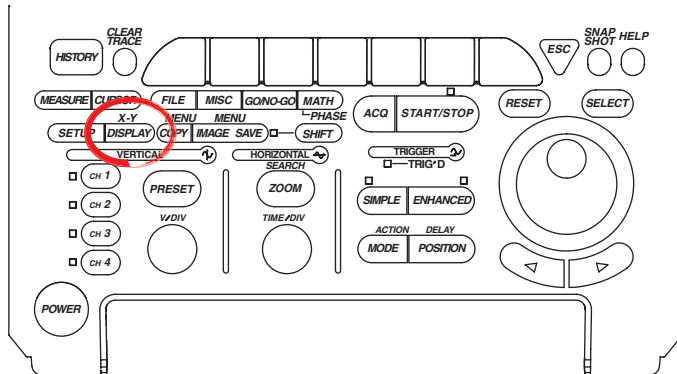

- To exit the menu during operation, press **ESC** located above the soft keys.
- For a description of the operation using a USB keyboard or a USB mouse, see section 4.3.

1. Press **DISPLAY**. The DISPLAY menu appears.
2. Press the **Graticule** soft key to select the graticule.

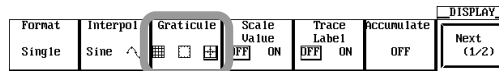

## Explanation

You can select from the following three types.

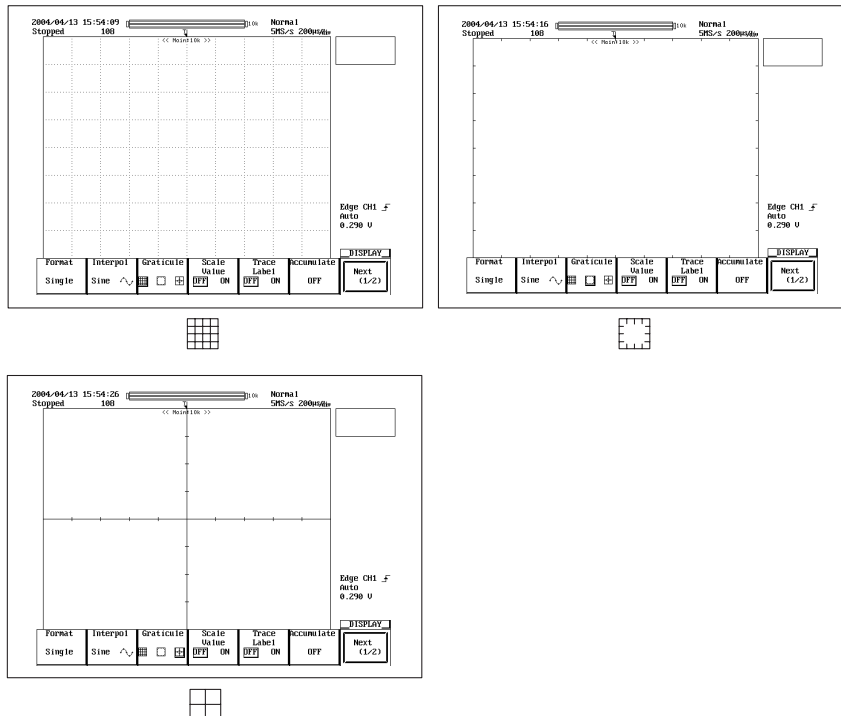

## 8.8 Turning the Scale Display ON and OFF

<For a description of this function, refer to page 2-20.>

### Procedure

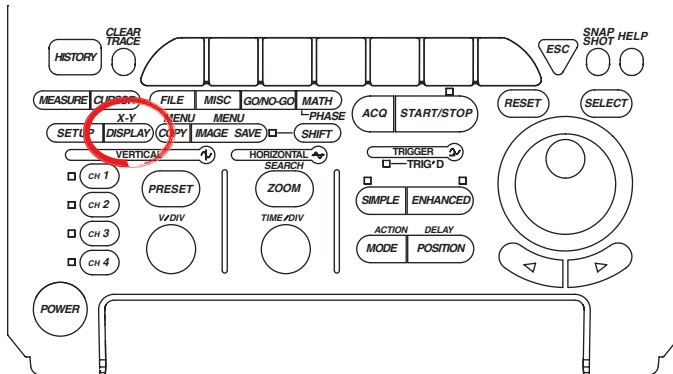

- To exit the menu during operation, press **ESC** located above the soft keys.
- For a description of the operation using a USB keyboard or a USB mouse, see section 4.3.

1. Press **DISPLAY**. The DISPLAY menu appears.
2. Press the **Scale Value** soft key to select ON or OFF.

#### When OFF

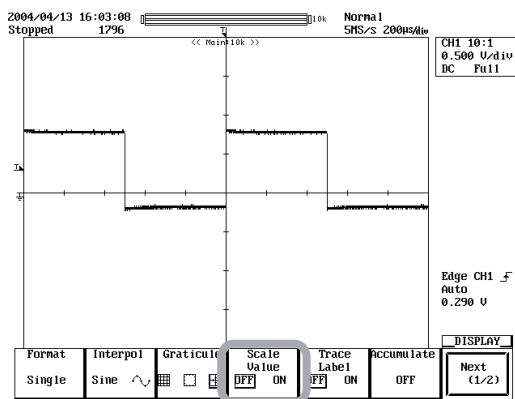

#### When ON

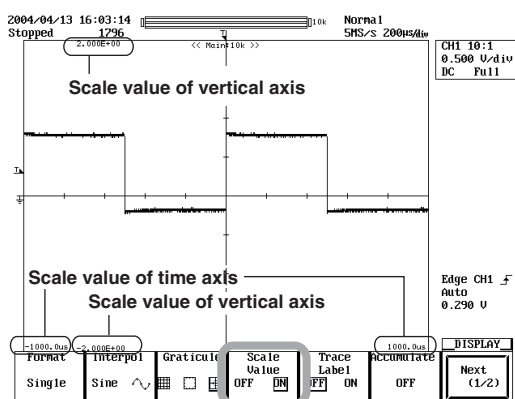

### Explanation

The upper and lower limits of the vertical and horizontal axis of each channel can be displayed.

# 8.9 Setting Waveform Labels

<For a description of this function, refer to page 2-20.>

## Procedure

### Setting Waveform Labels

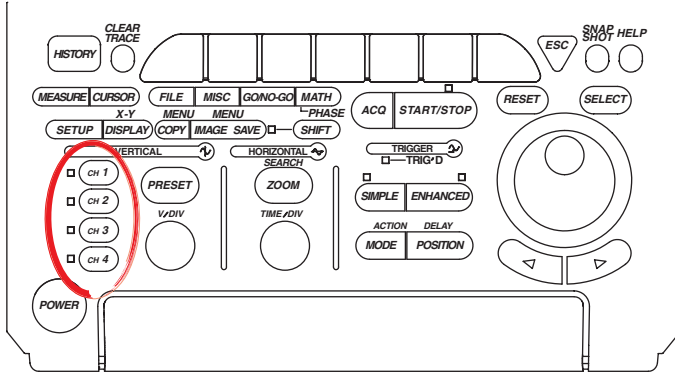

- To exit the menu during operation, press **ESC** located above the soft keys.
- For a description of the operation using a USB keyboard or a USB mouse, see section 4.3.

1. Press one of the **CH1 to CH4(2)** keys to select the channel on which to set labels.
2. Press the **Next (1/2)** soft key. The page 2 menu appears.

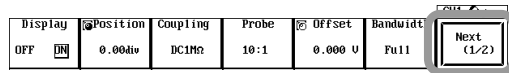

3. Press the **Label** soft key. A keyboard used to enter values and strings appears.

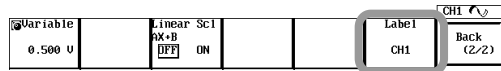

4. Use **jog shuttle & SELECT** to set the waveform label.

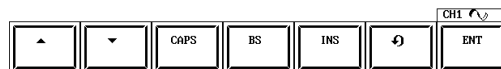
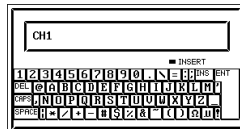

### Turning the Waveform Label Display ON and OFF

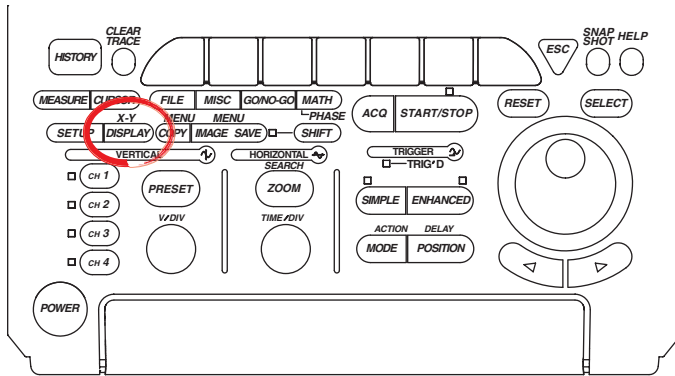

- To exit the menu during operation, press **ESC** located above the soft keys.
- For a description of the operation using a USB keyboard or a USB mouse, see section 4.3.

5. Press DISPLAY. The DISPLAY menu appears.
6. Press the Trace Label soft key to select ON or OFF.

#### When OFF

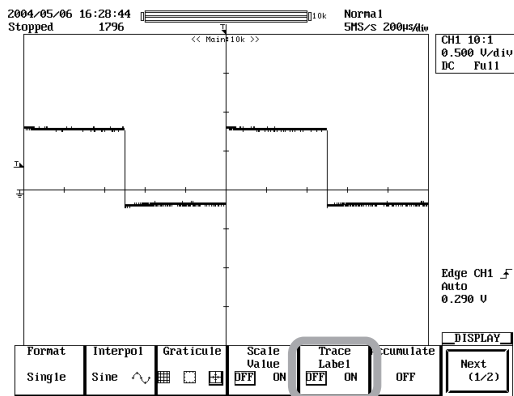

#### When ON

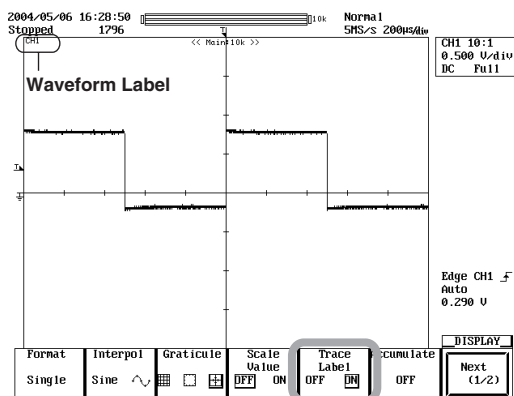

### Explanation

#### Turning the Waveform Label Display ON and OFF: Trace Label

You can select whether to display the label assigned to the channel of the displayed waveform.

#### Setting Waveform Labels

You can arbitrarily set the waveform label of each channel using up to eight characters. The label is applied to Trace Label, Scale Value, and Measure results.

# 8.10 Turning the Translucent Display ON and OFF

<For a description of this function, refer to page 2-20.>

## Procedure

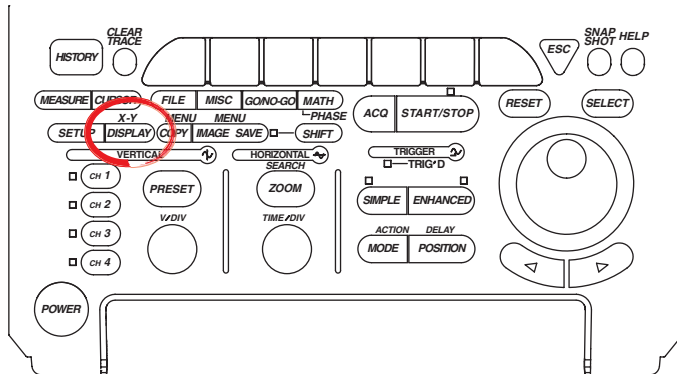

- To exit the menu during operation, press **ESC** located above the soft keys.
- For a description of the operation using a USB keyboard or a USB mouse, see section 4.3.

- Press **DISPLAY**. The DISPLAY menu appears.
- Press the **Next (1/2)** soft key. The page 2 menu appears.

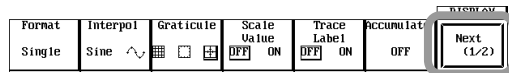

- Press the **Translucent** soft key to select ON or OFF.

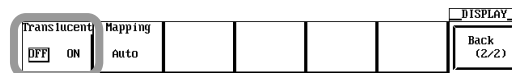

## Explanation

When this is turned to ON, dialog boxes become translucent. The contents underneath the dialog boxes can be seen.

When OFF

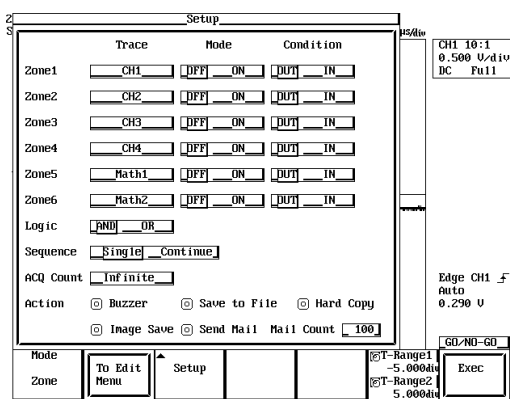

When ON

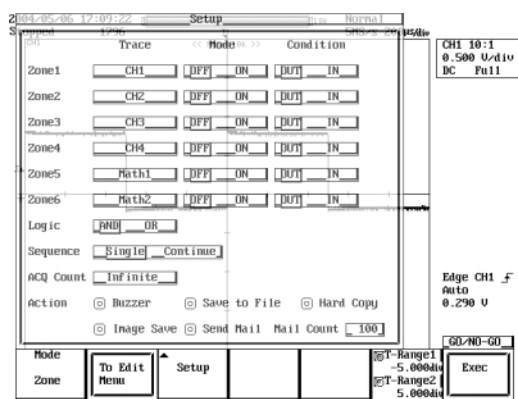

# 9.1 Displaying and Labeling Computed Waveforms

## Procedure

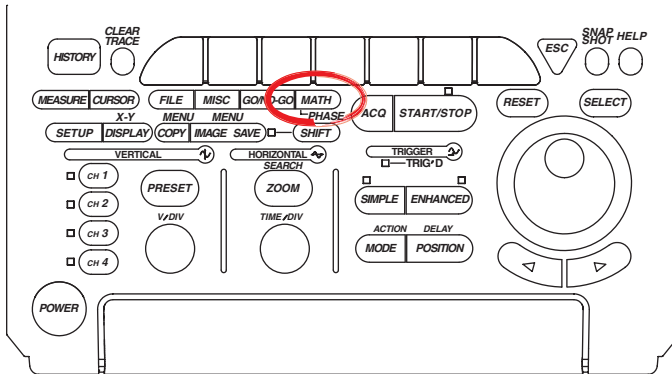

- To exit the menu during operation, press **ESC** located above the soft keys.
- For a description of the operation using a USB keyboard or a USB mouse, see section 4.3.

## Note

Steps 2 to 4 describe the setup procedures for computed waveform Math1. Perform similar steps for Math2.

### Turning the Computed Waveform Display ON and OFF

1. Press **MATH**. The MATH menu appears.
2. Press the **M1 Display** soft key to select ON or OFF.
  - If ON is selected, the Math1 waveform is displayed.
  - If OFF is selected, the Math1 waveform is not displayed.

M1 Display		M1 Setup	M1 Label	M2 Display		M2 Setup	M2 Label	MATH
OFF	ON	C1+C2	Math1	OFF	ON	C3+C4	Math2	

### Assigning Labels to Computed Waveforms

3. Press **M1 Label**. A keyboard used to enter values and strings appears.
4. Use **jog shuttle & SELECT** to set the label.

M1 Display		M1 Setup	M1 Label	M2 Display		M2 Setup	M2 Label	MATH
OFF	ON	C1+C2	Math1	OFF	ON	C3+C4	Math2	

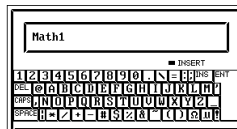

M1 Display		M1 Setup	M1 Label	M2 Display		M2 Setup	M2 Label	MATH
OFF	ON	C1+C2	Math1	OFF	ON	C3+C4	Math2	

## 9.1 Displaying and Labeling Computed Waveforms

---

### ***Explanation***

This section describes the setup procedures that are common to the computations described in section 9.2 to 9.8.

#### **Turning the Computed Waveform Display ON and OFF**

The display of the computed waveforms Math1 and Math2 can be turned ON/OFF separately.

ON: Computed waveforms are displayed.

OFF: Computed waveforms are not displayed.

#### **Computed Waveform Labels**

Labels can be assigned to computed waveforms Math1 and Math2 using up to eight characters.

- The type of characters that can be used are those displayed on the keyboard.
- For the procedure of turning ON/OFF the display of the assigned labels, see section 8.9.



## 9.2 Adding, Subtracting, and Multiplying Waveforms

<For a description of this function, refer to page 2-21.>

### Procedure

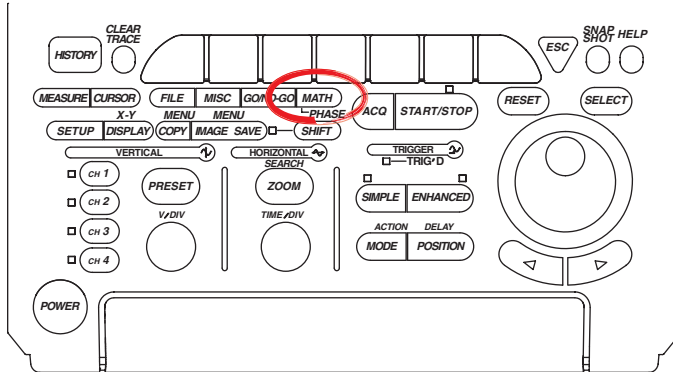

- To exit the menu during operation, press **ESC** located above the soft keys.
- In the procedural explanation below, the term **jog shuttle & SELECT** refers to the operation of selecting/setting items and entering values using the **jog shuttle** and **SELECT** and **RESET** keys. For details on this operation, see sections 4.1 and 4.2.
- For a description of the operation using a USB keyboard or a USB mouse, see section 4.3.

### Note

- Before carrying out the procedures in this section, you must first carry out the procedures for displaying and labeling computed waveforms in section 9.1.
- The setup procedures for computed waveform Math1 are described below. Perform similar steps for Math2.

- Press the **M1 Setup** soft key. The M1 Setup dialog box opens.

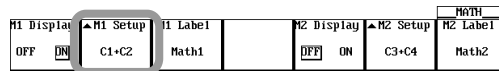

### Setting the Equation, Scaling, Unit, and Smoothing

- Use **jog shuttle & SELECT** to select the operator (+, -, or \*) and the waveform on which to perform computation.
 

When the M1 Setup dialog box is closed by pressing ESC or another key, the specified equation appears in the M1 Setup menu column.
- Use **jog shuttle & SELECT** to set the scaling, unit, and smoothing of computed waveform Math1.
- Press **ESC**. The M1 Setup dialog box closes.

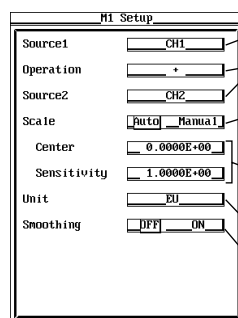

- Select the waveform on which to perform computation.
- Select the operator from +, -, and \*.
- Set the scaling used to display computed waveform Math1 to Auto (auto scaling) or Manual (manual scaling).
- If scaling is set to Manual, set the vertical center line level on the screen (voltage value if set to voltage) and the sensitivity (voltage per division if set to voltage).
- Set the unit of computed waveform Math1.
- Turn ON/OFF zooming.

**Explanation**

**Turning the Computed Waveform Display ON and OFF**

The display of the computed waveforms Math1 and Math2 can be turned ON/OFF individually. For details, see section 9.1.

**Operator**

Select the addition, subtraction, or multiplication operator (+, -, or \*) as the operator of Math1 and Math2. Addition, subtraction, and multiplication can be performed between the waveforms to be computed.

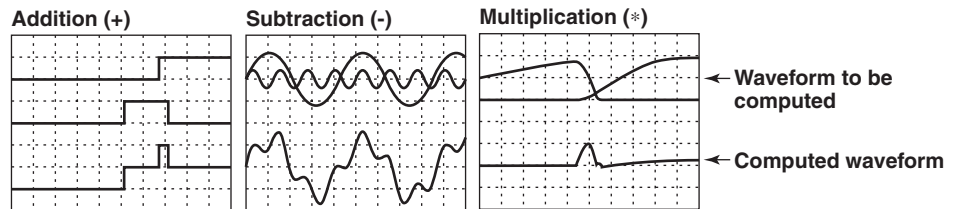

**Waveform to Be Computed**

The waveforms on which computation can be performed are as follows:

- For the DL1740E/DL1740EL

Computation Name	Source1	Source2
Math1	CH1 or CH2	One channel from CH1 to CH4
Math2	CH3 or CH4	One channel from CH1 to CH4 or Math1

- On the menu, CH1 to CH4 may be indicated as C1 to C4 and Math1 as M1.
- Math1 and Math2 can be computed simultaneously.

- For the DL17420E

Computation Name	Source1	Source2
Math1	CH1 or CH2	CH1 or CH2

- On the menu, CH1 to CH2 may be indicated as C1 and C2, and Math1 as M1.

**Scaling**

Scaling used to display computed waveforms Math1 and Math2 can be selected separately.

**Auto:** Set to auto scaling. The vertical center line level (voltage value if set to voltage) of the display frame and the sensitivity (voltage value per division if set to voltage) are automatically determined to display the computed waveform.

**Manual:** Set to manual scaling. The following items can be specified as necessary to display the computed waveform. The selectable range is  $-9.9999E+30$  to  $9.9999E+30$ .

- Center: The vertical center line level (voltage value if set to voltage) of the display frame can be specified.
- Sensitivity: The sensitivity (voltage value per division if set to voltage) can be specified.

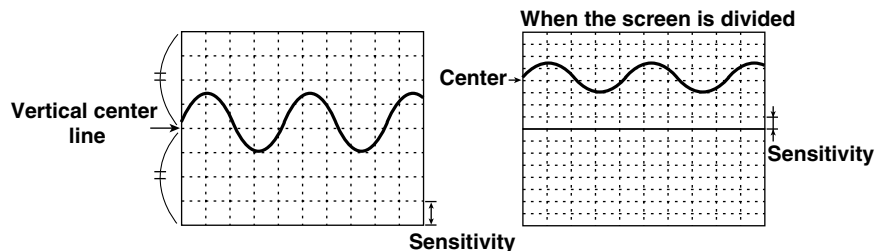

**Note**

If the scaling method is switched from manual to auto, the center and sensitivity values that you specified when in manual mode are set to auto scaled values.

### Unit of Computed Waveforms

Units can be assigned to computed waveforms Math1 and Math2 using up to four characters.

- The type of characters that can be used are those displayed on the keyboard.
- The specified unit is displayed along with the scaled value (section 8.4).

### Smoothing

Smoothing refers to the operation of deriving the weighted moving average every five points of the waveform to be computed. Since the process is performed on the waveform data stored in the acquisition memory, it can be performed even when acquisition is stopped. Smoothing has the frequency characteristics shown in the following diagram with respect to the sample rate. The -3 dB point is at approximately 13% of the sample rate.

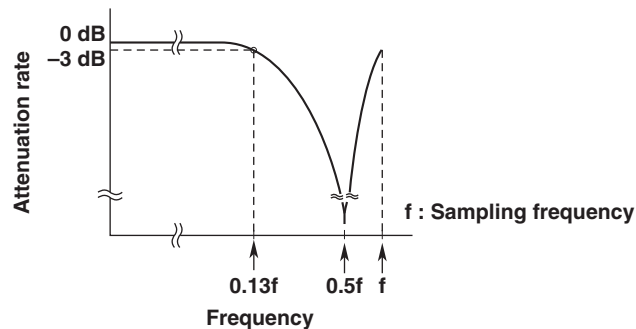

- You can select whether to perform computation using the smoothed waveform data for computed waveforms Math1 and Math2, separately.  
ON: Perform computation using the smoothed waveform data.  
OFF: Perform computation using the waveform data that is not smoothed.
- The smoothing setting applies to all computations of addition, subtraction, multiplication, binary computation, waveform inversion, differentiation, and integration. If the smoothing setting is changed on one of the computation settings, the change takes effect on all other computations (addition, subtraction, multiplication, binary computation, waveform inversion, differentiation, and integration). However, Math1 and Math2 can be set separately.

### Effects of Linear Scaling

If linear scaling is performed on the channel to be computed, computation is performed using linearly scaled values.

### Maximum Record Length That Can Be Computed

The maximum record lengths that can be computed on Math1 and Math2 are as follows:

- DL1720E: All record lengths can be computed
- DL1740E: All record lengths can be computed
- DL1740EL: When interleave is ON: 4 MWord  
When interleave mode is OFF: 2 MWord

### Computed Waveform Labels

Labels can be assigned to computed waveforms Math1 and Math2 using up to eight characters. For details, see section 9.1.

## 9.3 Performing Binary Computation

### Procedure

<For a description of this function, refer to page 2-21.>

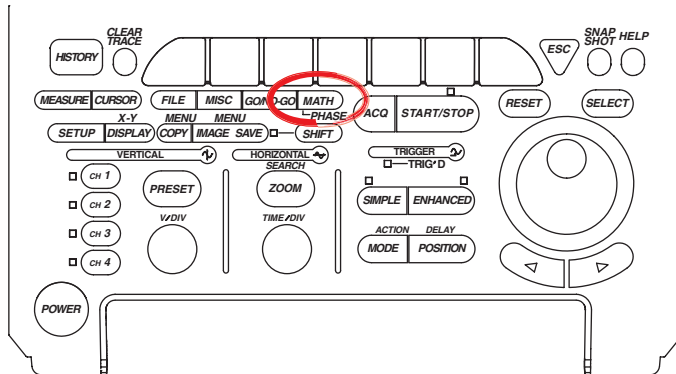

- To exit the menu during operation, press **ESC** located above the soft keys.
- In the procedural explanation below, the term **jog shuttle & SELECT** refers to the operation of selecting/setting items and entering values using the **jog shuttle** and **SELECT** and **RESET** keys. For details on this operation, see sections 4.1 and 4.2.
- For a description of the operation using a USB keyboard or a USB mouse, see section 4.3.

### Note

- Before carrying out the procedures in this section, you must first carry out the procedures for displaying and labeling computed waveforms in section 9.1.
- The setup procedures for computed waveform Math1 are described below. Perform similar steps for Math2.

- Press the **M1 Setup** soft key. The M1 Setup dialog box opens.

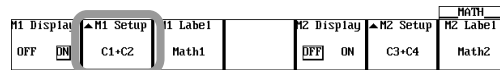

### Setting the Equation, Unit, Smoothing, and Threshold Level for Binary Computation

- Use **jog shuttle & SELECT** to select the operator for binary computation (Bin) and the waveform on which to perform computation.  
When the M1 Setup dialog box is closed by pressing **ESC** or another key, the specified equation appears in the M1 Setup menu column.
- Use **jog shuttle & SELECT** to set the unit, smoothing, and level when performing binary computation (convert into 0s and 1s) of computed waveform Math1.
- Press **ESC**. The M1 Setup dialog box closes.

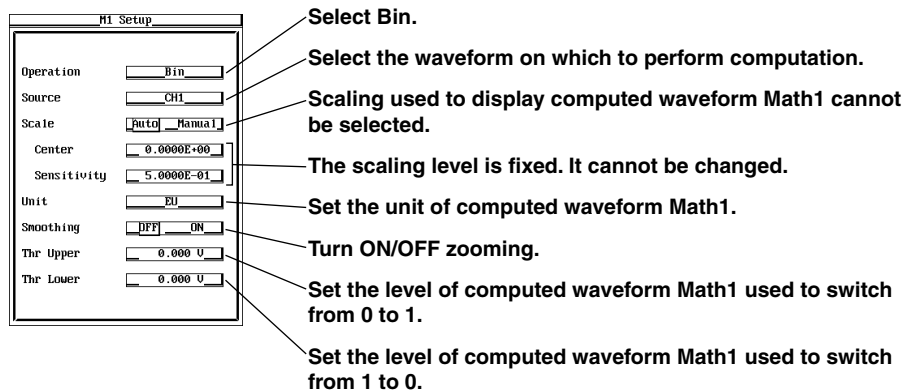

### Explanation

The waveform specified as CH1 to CH4 or Math1 (or waveform CH1-CH2 on the DL1720E) can be converted to a digital waveform of 0s and 1s with respect to the specified threshold level.

### Turning the Computed Waveform Display and Computed Waveform Label ON and OFF

See section 9.1.

#### Operator

Select the binary computation operator Bin as the operator of Math1 and Math2. The waveform to be computed can be converted to a digital waveform of 0s and 1s with respect to the specified threshold level.

#### Waveform to Be Computed

The waveforms on which computation can be performed are as follows:

- **For the DL1740E/DL1740EL**

Computation Name	Source
Math1	One channel from CH1 to CH4
Math2	One channel from CH1 to CH4 or Math1

- On the menu, CH1 to CH4 may be indicated as C1 to C4 and Math1 as M1.
- Math1 and Math2 can be computed simultaneously.

- **For the DL17420E**

Computation Name	Source
Math1	CH1 or CH2

- On the menu, CH1 to CH2 may be indicated as C1 and C2.

#### Scaling

Scaling is not available in binary computation. You can select Auto or Manual on the menu, but the computed result is not affected. The scaling level is fixed.

#### Unit of Computed Waveforms

The operation is the same as for addition, subtraction, and multiplication. See section 9.2.

#### Smoothing

The operation is the same as for addition, subtraction, and multiplication. See section 9.2.

#### Threshold Level for Binary Computation

You can set the level (voltage value if set to voltage) for setting the data values to 1 or 0 in binary computation for computed waveforms Math1 and Math2, separately (see the figure above). The selectable range is eight divisions within the screen. The resolution is 0.01 divisions.

Thr Upper: Set the level used to switch from 0 to 1.

Thr Lower: Set the level used to switch from 1 to 0.

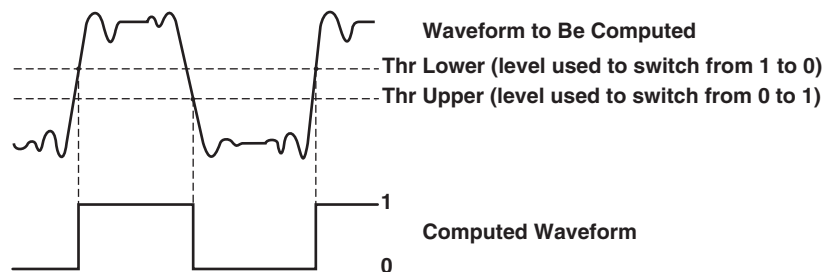

#### Effects of Linear Scaling

Even when linear scaling is performed on the channel to be computed, it does not affect the binary computation.

#### Maximum Record Length That Can Be Computed

The operation is the same as for addition, subtraction, and multiplication. See section 9.2.

## 9.4 Inverting Waveforms

### Procedure

<For a description of this function, refer to page 2-21.>

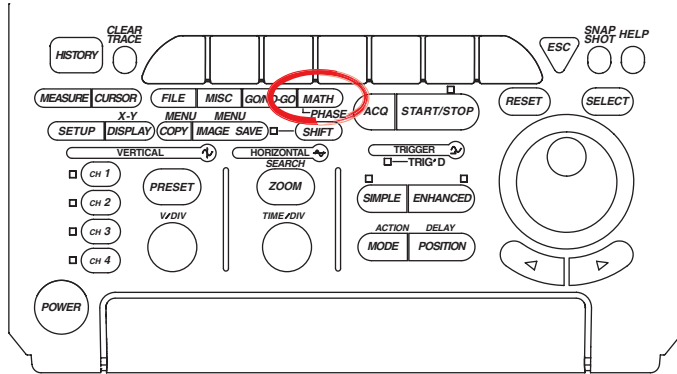

- To exit the menu during operation, press **ESC** located above the soft keys.
- In the procedural explanation below, the term **jog shuttle & SELECT** refers to the operation of selecting/setting items and entering values using the **jog shuttle** and **SELECT** and **RESET** keys. For details on this operation, see sections 4.1 and 4.2.
- For a description of the operation using a USB keyboard or a USB mouse, see section 4.3.

### Note

- Before carrying out the procedures in this section, you must first carry out the procedures for displaying and labeling computed waveforms in section 9.1.
- The setup procedures for computed waveform Math1 are described below. Perform similar steps for Math2.

- Press the **M1 Setup** soft key. The M1 Setup dialog box opens.

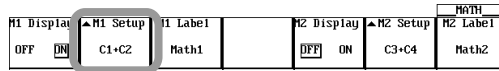

### Setting the Equation, Scaling, Unit, and Smoothing

- Use **jog shuttle & SELECT** to select the inversion operator (Invert) and the waveform on which to perform computation.  
When the M1 Setup dialog box is closed by pressing **ESC** or another key, the specified equation appears in the M1 Setup menu column.
- Use **jog shuttle & SELECT** to set the scaling, unit, and smoothing of computed waveform Math1.
- Press **ESC**. The M1 Setup dialog box closes.

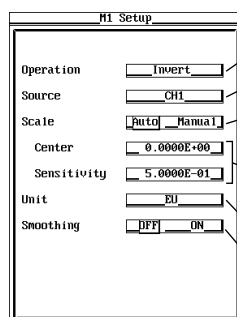

- Select **Invert**.
- Select the waveform on which to perform computation.
- Set the scaling used to display computed waveform Math1 to **Auto** (auto scaling) or **Manual** (manual scaling).
- If scaling is set to **Manual**, set the vertical center line level on the screen (voltage value if set to voltage) and the sensitivity (voltage per division if set to voltage).
- Set the unit of computed waveform Math1.
- Turn **ON/OFF** zooming.

**Explanation**

Turning the Computed Waveform Display and Computed Waveform Label ON and OFF  
See section 9.1.

**Operator**

Select the inversion operator Invert as the operator for Math1 and Math2. The waveform to be computed is inverted vertically (around the 0 level of the waveform) by multiplying the waveform data by  $-1$ .

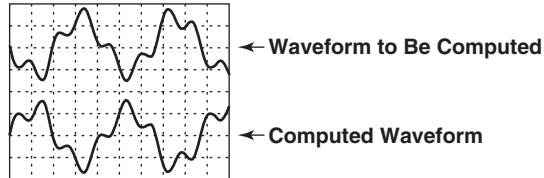
**Waveform to Be Computed**

The waveforms on which computation can be performed are as follows:

- **For the DL1740E/DL1740EL**

Computation Name	Source
Math1	One channel from CH1 to CH4
Math2	One channel from CH1 to CH4 or Math1

- On the menu, CH1 to CH4 may be indicated as C1 to C4 and Math1 as M1.
- Math1 and Math2 can be computed simultaneously.

- **For the DL17420E**

Computation Name	Source
Math1	CH1 or CH2

- On the menu, CH1 to CH2 may be indicated as C1 and C2.

**Scaling**

The operation is the same as for addition, subtraction, and multiplication. See section 9.2.

**Unit of Computed Waveforms**

The operation is the same as for addition, subtraction, and multiplication. See section 9.2.

**Smoothing**

The operation is the same as for addition, subtraction, and multiplication. See section 9.2.

**Effects of Linear Scaling**

The operation is the same as for addition, subtraction, and multiplication. See section 9.2.

**Maximum Record Length That Can Be Computed**

The operation is the same as for addition, subtraction, and multiplication. See section 9.2.

# 9.5 Differentiating and Integrating Waveforms

## Procedure

<For a description of this function, refer to page 2-21.>

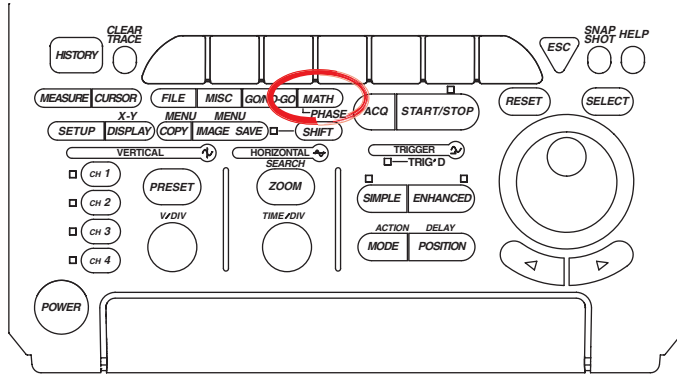

- To exit the menu during operation, press **ESC** located above the soft keys.
- In the procedural explanation below, the term **jog shuttle & SELECT** refers to the operation of selecting/setting items and entering values using the **jog shuttle** and **SELECT** and **RESET** keys. For details on this operation, see sections 4.1 and 4.2.
- For a description of the operation using a USB keyboard or a USB mouse, see section 4.3.

## Note

- Before carrying out the procedures in this section, you must first carry out the procedures for displaying and labeling computed waveforms in section 9.1.
- The setup procedures for computed waveform Math1 are described below. Perform similar steps for Math2.

1. Press the **M1 Setup** soft key. The M1 Setup dialog box opens.

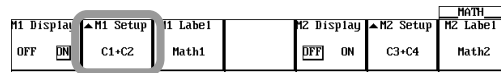

## Setting the Equation, Scaling, Unit, Smoothing, and Integration Start Point

2. Use **jog shuttle & SELECT** to select the differentiation or integration operator (Diff or Integ) and the waveform on which to perform computation.  
When the M1 Setup dialog box is closed by pressing **ESC** or another key, the specified equation appears in the M1 Setup menu column.
3. Use **jog shuttle & SELECT** to set the scaling, unit, and smoothing of computed waveform Math1.
4. If the integration operator Integ is selected, use **jog shuttle & SELECT** to set the start point of integration.
5. Press **ESC**. The M1 Setup dialog box closes.

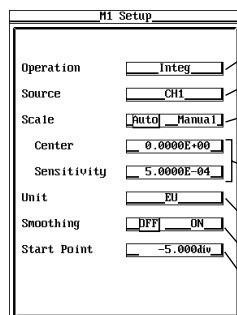

- Select Diff or Integ.
- Select the waveform on which to perform computation.
- Set the scaling used to display computed waveform Math1 to Auto (auto scaling) or Manual (manual scaling).
- If scaling is set to Manual, set the vertical center line level on the screen (voltage value if set to voltage) and the sensitivity (voltage per division if set to voltage).
- Set the unit of computed waveform Math1.
- Turn ON/OFF zooming.
- When performing integration (operator Integ), set the integration start point.  
This item does not appear when performing differentiation.



**Explanation**

Turning the Computed Waveform Display and Computed Waveform Label ON and OFF  
See section 9.1.

**Operator**

Select the differentiation operator Diff or integration operator Integ as the operator for Math1 and Math2. The waveform to be computed can be differentiated or integrated.

**Waveform to Be Computed**

The waveforms on which computation can be performed are as follows:

- **For the DL1740E/DL1740EL**

Computation Name	Source
Math1	One channel from CH1 to CH4
Math2	One channel from CH1 to CH4 or Math1

- On the menu, CH1 to CH4 may be indicated as C1 to C4 and Math1 as M1.
- Math1 and Math2 can be computed simultaneously.

- **For the DL17420E**

Computation Name	Source
Math1	CH1 or CH2

- On the menu, CH1 to CH2 may be indicated as C1 and C2.

**Scaling**

The operation is the same as for addition, subtraction, and multiplication. See section 9.2.

**Unit of Computed Waveforms**

The operation is the same as for addition, subtraction, and multiplication. See section 9.2.

**Smoothing**

The operation is the same as for addition, subtraction, and multiplication. See section 9.2.

**Integration Start Point**

You can set the start point of integration. The selectable range is  $\pm 5$  divisions, and the resolution is ten divisions  $\div$  display record length. For a description of the display record length, see appendix 1.

**Effects of Linear Scaling**

The operation is the same as for addition, subtraction, and multiplication. See section 9.2.

**Maximum Record Length That Can Be Computed**

The operation is the same as for addition, subtraction, and multiplication. See section 9.2.

## 9.6 Performing Power Spectrum Computation (FFT)

<For a description of this function, refer to page 2-22.>

### Procedure

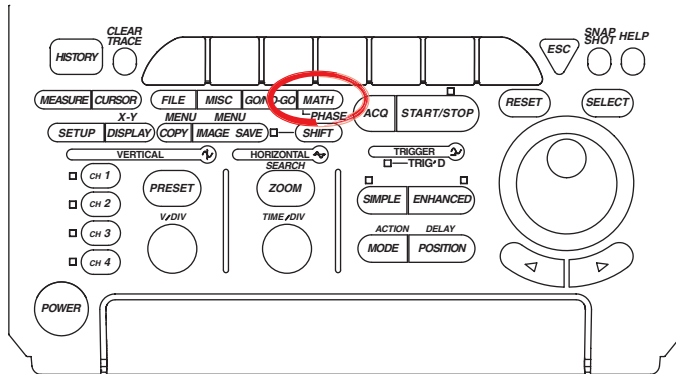

- To exit the menu during operation, press **ESC** located above the soft keys.
- In the procedural explanation below, the term **jog shuttle & SELECT** refers to the operation of selecting/setting items and entering values using the **jog shuttle** and **SELECT** and **RESET** keys. For details on this operation, see sections 4.1 and 4.2.
- For a description of the operation using a USB keyboard or a USB mouse, see section 4.3.

### Note

- Before carrying out the procedures in this section, you must first carry out the procedures for displaying and labeling computed waveforms in section 9.1.
- The setup procedures for computed waveform Math1 are described below. Perform similar steps for Math2.

- Press the **M1 Setup** soft key. The M1 Setup dialog box opens.

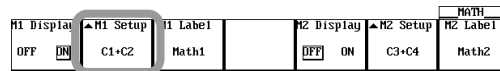

### Setting the Equation, Scaling, Unit, Integration Start Point, Number of Computed Points, and the Time Window

- Use **jog shuttle & SELECT** to select the power spectrum computation operator (PS) and the waveform on which to perform computation.
 

When the M1 Setup dialog box is closed by pressing **ESC** or another key, the specified equation appears in the M1 Setup menu column.
- Use **jog shuttle & SELECT** to set the scaling, unit, computation start point, the number of computed points, and the time window of computed waveform Math1.
- Press **ESC**. The M1 Setup dialog box closes.

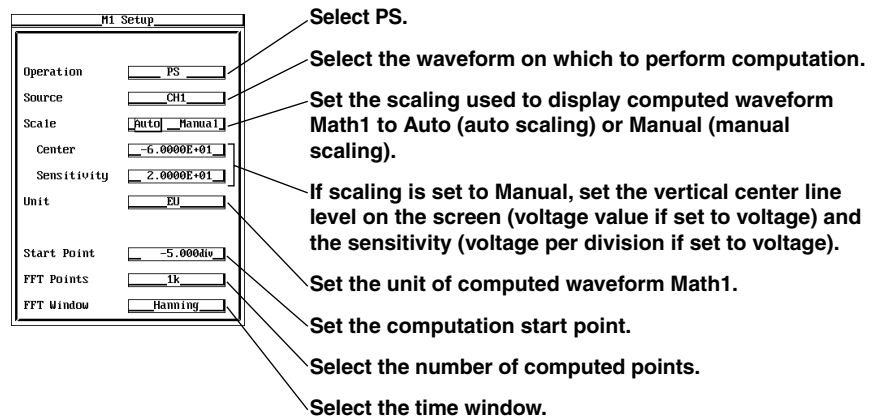

### Explanation

Turning the Computed Waveform Display and Computed Waveform Label ON and OFF. See section 9.1.

**Operator**

Select the power spectrum computation operator PS as the operator of Math1 and Math2. The power spectrum of the waveform to be computed can be determined by taking the FFT (Fast Fourier Transform).

**Waveform to Be Computed**

The waveforms on which computation can be performed are as follows:

- **For the DL1740E/DL1740EL**

Computation Name	Source
Math1	One channel from CH1 to CH4
Math2	One channel from CH1 to CH4 or Math1

- On the menu, CH1 to CH4 may be indicated as C1 to C4 and Math1 as M1.
- Math1 and Math2 can be computed simultaneously.

- **For the DL17420E**

Computation Name	Source
Math1	CH1 or CH2

- On the menu, CH1 to CH2 may be indicated as C1 and C2.

**Scaling**

The operation is the same as for addition, subtraction, and multiplication. See section 9.2.

**Unit of Computed Waveforms**

The operation is the same as for addition, subtraction, and multiplication. See section 9.2.

**Computation Start Point**

You can set the point where power spectrum computation is to start. The selectable range is  $\pm 5$  divisions, and the resolution is ten divisions  $\div$  display record length. For a description of the display record length, see appendix 1.

**Number of Computed Points**

You can select a range for power spectrum computation of 1 kWord or 10 kWord.

**Selecting the Time Window**

You can select the time window.

Rect (Rectangular): Best suited for transient signals that attenuate completely within the time window.

Hanning Window: Best suited for continuous and non-periodic signals.

Flattop Window: Best suited for improving the accuracy of the level even if the frequency resolution is to be compromised.

**Effects of Linear Scaling**

If linear scaling is performed on the channel to be computed, computation is performed using the linearly scaled values and affects the level of the power spectrum computation result.

**Maximum Record Length That Can Be Computed**

The operation is the same as for addition, subtraction, and multiplication. See section 9.2.

**Note**

- An asterisk is displayed at the upper left corner of the screen while power spectrum computation is in progress.
- The power spectrum cannot be computed if the displayed record length is less than number of computed points. In addition, it cannot be computed when the number of data points after the computation start point is less than the number of computed points.
- Power spectrum computation is performed on the data stored in the acquisition memory. For waveforms acquired in envelope mode, computation is performed on the maximum and minimum values per acquisition interval.

## 9.7 Smoothing Waveforms

### Procedure

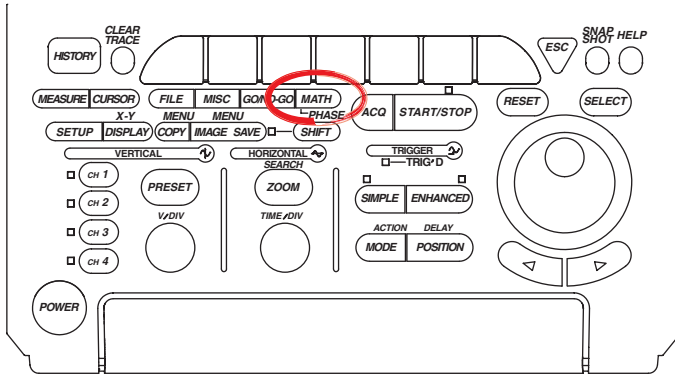

- To exit the menu during operation, press **ESC** located above the soft keys.
- In the procedural explanation below, the term **jog shuttle & SELECT** refers to the operation of selecting/setting items and entering values using the **jog shuttle** and **SELECT** and **RESET** keys. For details on this operation, see sections 4.1 and 4.2.
- For a description of the operation using a USB keyboard or a USB mouse, see section 4.3.

### Note

- Before carrying out the procedures in this section, you must first carry out the procedures for displaying and labeling computed waveforms in section 9.1.
- The setup procedures for computed waveform Math1 are described below. Perform similar steps for Math2.

- Press the **M1 Setup** soft key. The M1 Setup dialog box opens.

M1 Display	M1 Setup	M1 Label	M2 Display	M2 Setup	M2 Label	MATH
OFF	ON	C1+C2	Math1	OFF	ON	C3+C4
						Math2

### Setting the Equation, Scaling, Unit, and Smoothing

- Use **jog shuttle & SELECT** to select the Pass-Thru operator and the waveform on which to perform computation.
 

When the M1 Setup dialog box is closed by pressing ESC or another key, the specified equation appears in the M1 Setup menu column.
- Use **jog shuttle & SELECT** to set the scaling, unit, and smoothing of computed waveform Math1.
- Press **ESC**. The M1 Setup dialog box closes.

M1 Setup	
Operation	Pass-Thru
Source	CH1
Scale	Auto Manual
Center	0.0000E+00
Sensitivity	5.0000E-01
Unit	VU
Smoothing	OFF ON

- Select Pass-Thru.
- Select the waveform on which to perform computation.
- Set the scaling used to display computed waveform Math1 to Auto (auto scaling) or Manual (manual scaling).
- If scaling is set to Manual, set the vertical center line level on the screen (voltage value if set to voltage) and the sensitivity (voltage per division if set to voltage).
- Set the unit of computed waveform Math1.
- Turn ON/OFF zooming.

**Explanation**

Turning the Computed Waveform Display and Computed Waveform Label ON and OFF  
See section 9.1.

**Operator**

Select the operator Pass-Thru as the operator for Math1 and Math2. Select the Pass-Thru operator when displaying the waveform to be computed that has been simply scaled or smoothed. For details smoothing, see section 9.2.

- **When using the Pass-Thru operator and smoothing is ON**

The waveform to be computed is displayed after smoothing.

- **When using the Pass-Thru operator and smoothing is OFF**

The waveform to be computed is displayed without smoothing.

**Waveform to Be Computed**

The waveforms on which computation can be performed are as follows:

- **For the DL1740E/DL1740EL**

Computation Name	Source
Math1	One channel from CH1 to CH4
Math2	One channel from CH1 to CH4 or Math1

- On the menu, CH1 to CH4 may be indicated as C1 to C4 and Math1 as M1.
- Math1 and Math2 can be computed simultaneously.

- **For the DL17420E**

Computation Name	Source
Math1	CH1 or CH2

- On the menu, CH1 to CH2 may be indicated as C1 and C2.

**Scaling**

The operation is the same as for addition, subtraction, and multiplication. See section 9.2.

**Unit of Computed Waveforms**

The operation is the same as for addition, subtraction, and multiplication. See section 9.2.

**Smoothing**

The operation is the same as for addition, subtraction, and multiplication. See section 9.2.

**Effects of Linear Scaling**

If linear scaling is performed on the channel to be computed, computation is performed using linearly scaled values.

**Maximum Record Length That Can Be Computed**

The operation is the same as for addition, subtraction, and multiplication. See section 9.2.

## 9.8 Shifting the Phase

### Procedure

<For a description of this function, refer to page 2-21.>

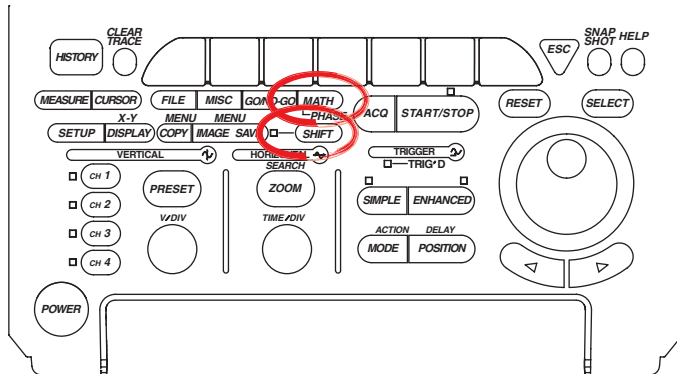

- To exit the menu during operation, press **ESC** located above the soft keys.
- In the procedural explanation below, the term **jog shuttle & SELECT** refers to the operation of selecting/setting items and entering values using the **jog shuttle** and **SELECT** and **RESET** keys. For details on this operation, see sections 4.1 and 4.2.
- For a description of the operation using a USB keyboard or a USB mouse, see section 4.3.

1. Press **SHIFT+MATH(Phase)**. The PHASE menu appears.

#### Turning the Phase-Shifted Waveforms ON and OFF

2. Press the **Mode** soft key to select ON or OFF.
  - When ON is selected, the phase of the displayed waveform is shifted. The amount of shift is specified in step 3 and subsequent steps.
  - When OFF is selected, the phase of the displayed waveform is not shifted.

Mode	CH1	CH2	CH3	CH4	PHASE
OFF ON	0.0%	0.0%	0.0%	0.0%	

#### You can set the amount of shift.

3. Press the **CH1 to CH4(2)** soft key to select the channel for setting the amount of shift.
 

CH3 and CH4 are not displayed on the DL1720E.
4. Use **jog shuttle & SELECT** to set the amount of shift.

Mode	CH1	CH2	CH3	CH4	PHASE
OFF ON	0.0%	0.0%	0.0%	0.0%	

## Explanation

This section explains the setup procedures for displaying the waveforms of CH1 to CH4(2) with the phase shifted.

### Turning the Phase-Shifted Waveforms ON and OFF

You can turn ON/OFF the display of the phase-shifted waveforms of CH1 to CH4(2).

ON: The phase-shifted waveform is displayed

OFF: The phase-shifted waveform is not displayed

### Target Channels for Phase Shifting

The target channels for phase shifting are CH1 to CH4 on the DL1740E/DL1740EL and CH1 to CH2 on the DL1720E.

### Amount of Shift

You can set the amount of shift.

- The selectable range is a time value in the range of  $-(\text{record length}/2)$  to  $(\text{record length}/2)$ .
- The resolution is  $1 \div \text{sample rate}^*$ .

\* The sample rate varies depending on the record length or T/div setting.  
For details on the sample rate, see appendix 1.

### Note

- If the waveforms to be computed that were selected in sections 9.2 to 9.7 and 9.9 are phase shifted, the phase-shifted waveforms are used in the computation.
- If you change T/div after setting the amount of shift, the amount of shift (time value) does not change. The displayed waveform is only expanded or reduced along the time axis.
- The selectable range and resolution of the amount of shift vary depending on the T/div setting. The behavior when you change T/div after setting the amount of shift is indicated below. If you change T/div back to the original setting without changing the amount of shift, the original amount of shift returns.
  - When T/div is set faster (the T/div value is decreased) and the specified amount of shift exceeds the selectable range of the amount of shift at the new T/div setting, the amount of shift is set to the maximum value of the selectable range at the new T/div setting.
  - When T/div is set slower (the T/div value is increased) and the specified resolution of the amount of shift falls below the resolution of the amount of shift at the new T/div setting, the resolution is set to the resolution of the amount of shift at the new T/div setting.

# 10.1 Displaying History Waveforms

<For a description of this function, refer to page 2-23.>

## Procedure

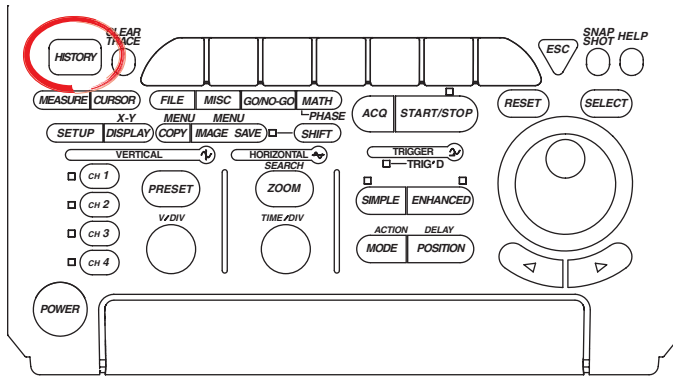

- To exit the menu during operation, press **ESC** located above the soft keys.
- For a description of the operation using a USB keyboard or a USB mouse, see section 4.3.

1. Press **HISTORY**. The HISTORY menu appears.

### Displaying History Waveforms One by One

2. Press the **Select Record** soft key.

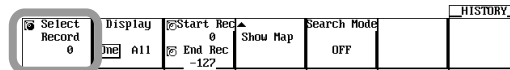

3. Turn the **jog shuttle** to select the number of the record to be displayed.  
You can select the record number in the range of Start Rec to End Rec shown on the menu.
4. Press the **Display** soft key to select One. Only the waveform of the record number indicated in Select Record on the menu is displayed.

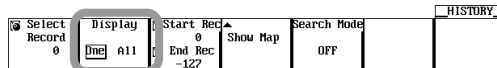

### Accumulating (Collectively Displaying) the History Waveforms

#### • Setting the Range to be Accumulated

2. Press the **Start Rec/End Rec** soft key to set the jog shuttle control to Start Rec or End Rec.
  - If you select Start Rec, you can select the record number for starting the accumulation.
  - If you select End Rec, you can select the record number for ending the accumulation.



3. Turn the **jog shuttle** to set the record number at which accumulation is to be started or ended.
4. Press the **Display** soft key to select All. The waveforms in the range between Start Rec and End Rec shown on the menu are accumulated on the screen.  
The waveform of the record number indicated in Select Record on the menu is highlighted.

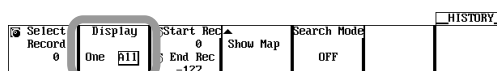



## 10.1 Displaying History Waveforms

### Selecting the Highlighted Waveform

- Press the **Select Record** soft key.

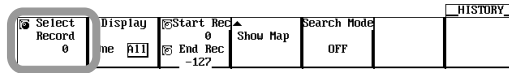

- Turn the **jog shuttle** to select the number of the record to be high lit. The waveform of the selected record number is highlighted.

### Selecting the Waveforms to be Displayed on the History Map

#### • Displaying the History Map

- Press the **Start Rec/End Rec** soft key to set the jog shuttle control to Start Rec or End Rec.
  - If you select Start Rec, you can select the first record number displayed on the history map.
  - If you select End Rec, you can select the last record number displayed on the history map.

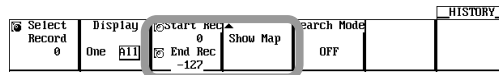

- Turn the **jog shuttle** to set the first or last record number displayed on the history map.
- Press the **Show Map** soft key. The record numbers and time stamps (time when acquisition was completed) of the waveforms in the range of Start Rec to End Rec on the menu are listed.

History Memory Map		
#-0059 15:19:31.99	#-0064 15:19:31.57	#-0109 15:19:31.15
#-0060 15:19:31.97	#-0065 15:19:31.55	#-0110 15:19:31.13
#-0061 15:19:31.95	#-0066 15:19:31.53	#-0111 15:19:31.11
#-0062 15:19:31.94	#-0067 15:19:31.52	#-0112 15:19:31.10
#-0063 15:19:31.92	#-0068 15:19:31.50	#-0113 15:19:31.08
#-0064 15:19:31.90	#-0069 15:19:31.48	#-0114 15:19:31.06
#-0065 15:19:31.89	#-0090 15:19:31.47	#-0115 15:19:31.05
#-0066 15:19:31.87	#-0091 15:19:31.45	#-0116 15:19:31.03
#-0067 15:19:31.85	#-0092 15:19:31.43	#-0117 15:19:31.01
#-0068 15:19:31.84	#-0093 15:19:31.42	#-0118 15:19:31.00
#-0069 15:19:31.82	#-0094 15:19:31.40	#-0119 15:19:30.98
#-0070 15:19:31.80	#-0095 15:19:31.38	#-0120 15:19:30.96
#-0071 15:19:31.79	#-0096 15:19:31.37	#-0121 15:19:30.95
#-0072 15:19:31.77	#-0097 15:19:31.35	#-0122 15:19:30.93
#-0073 15:19:31.75	#-0098 15:19:31.33	
#-0074 15:19:31.74	#-0099 15:19:31.32	
#-0075 15:19:31.72	#-0100 15:19:31.30	
#-0076 15:19:31.70	#-0101 15:19:31.28	
#-0077 15:19:31.69	#-0102 15:19:31.27	
#-0078 15:19:31.67	#-0103 15:19:31.25	
#-0079 15:19:31.65	#-0104 15:19:31.23	
#-0080 15:19:31.64	#-0105 15:19:31.22	
#-0081 15:19:31.62	#-0106 15:19:31.20	
#-0082 15:19:31.60	#-0107 15:19:31.18	
#-0083 15:19:31.58	#-0108 15:19:31.16	

#### • Selecting the Waveform to Be Displayed

- Use **jog shuttle & SELECT** to select the waveform to be displayed. The selected waveform is displayed, and the record number of the selected waveform is indicated in Select Record on the menu.
  - If Display is set to One, only the selected waveform is displayed.
  - If the Display is set to All, the selected waveform is highlighted.

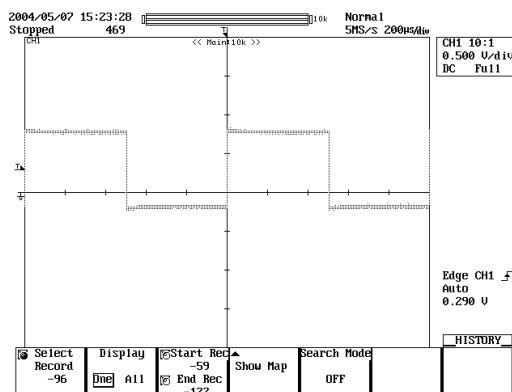

**Explanation**

This section describes the procedures for displaying history waveforms. The waveforms that have been sequentially stored can also be displayed in the same fashion.

**Number of History Waveforms**

The table below shows the number of history waveforms that can be stored and held in the acquisition memory according to the maximum record length and specified record length of each model. If a waveform is acquired when (a trigger is activated) causing this number to be exceeded, the oldest waveform is cleared.

Specified Record Length	DL1720E	DL1740E	DL1740EL
1 kWord	1-1024 (2048)	1-1024 (2048)	1-1024 (2048)
10 kWord	1-128 (256)	1-128 (256)	1-128 (256)
50 kWord	1-32 (64)	1-32 (64)	1-32 (64)
100 kWord	1-16 (32)	1-16 (32)	1-16 (32)
250 kWord	1-8 (16)	1-8 (16)	1-8 (16)
1 MWord	- (4)	1-2 (4)	1-2 (4)
2 MWord	-	- (2)	1 (2)
4 MWord	-	-	1 (1)
8 MWord	-	-	- (1)

- If the trigger count is 1, only the displayed waveform is held in the acquisition memory; past waveforms are not held.
- Values inside the parentheses are the number of waveforms when interleave mode is ON.
- When performing box averaging, acquisition is possible up to 250 MW on the DL1720E (or up to 500 MW when interleave mode is ON), up to 500 MW on the DL1740E (up to 1 MW when interleave mode is ON), and up to 2 MW on the DL1740EL (or up to 4 MW when interleave mode is ON).

**Selectable Range of History Waveforms**

- History waveforms have record numbers attached to them.
- The newest (current) waveform is 0, the waveform previous to that is -1, and so on.
- To select the waveform to be displayed, select the record number in the range of 0 to -(the number of history waveforms -1). The number of history waveforms varies depending on the specified record length as indicated in the table above.
- The default value is 0.

**Display Mode**

You can select the display mode.

- One: Displays only the waveform of the record number selected by Select Record from the range specified by Start Record and End Record.
- All: Displays accumulated all the waveforms in the range specified by Start Record and End Record. The waveform selected by Select Record is highlighted (displayed brightly).

**History Map: Show Map**

- The record numbers and time stamps (time when acquisition was completed displayed in hour:minute:second.1/100 second format) of the history waveforms are listed.
- The information of seventy-five waveforms is displayed on 1 screen.
- You can scroll and select the data to be displayed using the jog shuttle and display the selected waveform.

### **Note**

#### **Notes on Using the History Memory Function**

- The history memory function cannot be used if the acquisition mode is Average.
- The history memory function cannot be used when in repetitive sampling mode.
- If waveform acquisition is aborted, only the waveforms that have been acquired completely can be displayed.
- The history memory function cannot be used in roll mode. The display format is automatically set to roll mode depending on the time axis and record length settings (see appendix 1).
- If you stop the waveform acquisition and restart without changing the waveform acquisition conditions, the waveform acquisition count of the history waveforms is not reset, and the remaining number of acquisitions are stored and held as history waveforms. The history waveforms that have been held up to the point when the acquisition was stopped are retained.
- If you change the waveform acquisition conditions, history waveforms up to that point are cleared when you restart acquisition using the new settings.
- If you press the CLEAR TRACE key while waveform acquisition is in progress or if you stop waveform acquisition, press the CLEAR TRACE key, and restart acquisition, the history waveforms are cleared.

#### **Notes on Displaying History Waveforms**

- When the history memory menu is displayed, waveform acquisition stops. History waveforms cannot be displayed while waveform acquisition is in progress.
  - You can start waveform acquisition even when the history memory menu is displayed. However, while acquisition is in progress, you cannot change the settings of the history memory function such as Select Record.
  - Settings are restricted by the following condition: End Record  $\leq$  Select Record  $\leq$  Start Record.
  - If waveform data is loaded from a file stored on the specified storage medium, the history waveforms up to that point are cleared. The loaded waveform data is always recalled to the record number 0 position of the history memory. If a file containing multiple waveforms is loaded, the newest waveform is recalled in the record number 0 position, the next newest waveform in -1, and so on.
  - Computation and automated measurement of waveform parameters are performed on the waveform of the record number specified by Select Record. Computation and analysis of old waveforms is possible until the history waveforms are changed by restarting acquisition.
  - Past waveforms are held in roll mode. Only one waveform when acquisition is stopped is stored in the record number 0 position.
  - It may take some time to display all the history waveforms if the number of waveforms to be displayed is large. To abort, set the display mode to One.
  - Turning OFF the power clears the history waveforms.
-

## 10.2 Searching the History Waveforms Using Zones (History Search)

<For a description of this function, refer to page 2-23.>

### Procedure

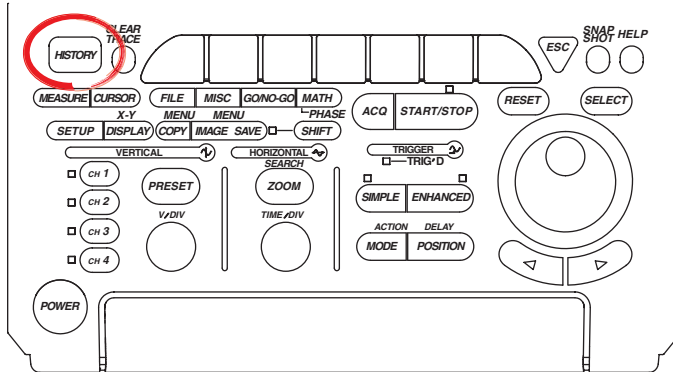

- To exit the menu during operation, press **ESC** located above the soft keys.
- For a description of the operation using a USB keyboard or a USB mouse, see section 4.3.

- Press **HISTORY**. The HISTORY menu appears.
- Press the **Search Mode** soft key. The Search Mode menu appears.

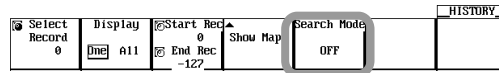

- Press the **Zone** soft key.

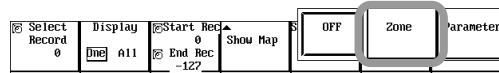

### Setting the Search Zone and Search Conditions

- Press the **Search Setup** soft key. The Search Setup menu appears.

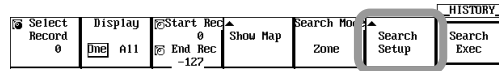

### Selecting the Zone for Registering Search Conditions

- Press the **Select Zone** soft key. The Select Zone menu appears.

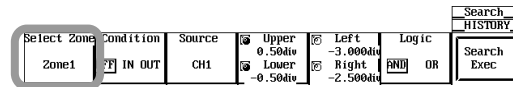

- Press any of the **Zone1** to **Zone4** soft keys to select the parameter in which search conditions are to be registered.

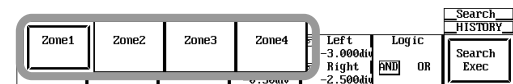

### Selecting Conditions of the Waveform to Search for in the Search Zone

- Press the **Condition** soft key to select OFF, IN, or OUT.  
If you select IN or OUT and select a displayed waveform in step 9, the search zone (rectangular frame) is displayed.

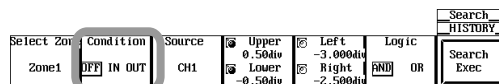

## 10.2 Searching the History Waveforms Using Zones (History Search)

### Selecting the Search Target Waveform

- Press the **Source** soft key. The Source menu appears.

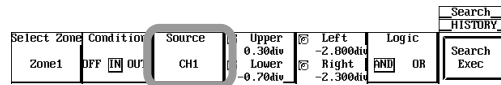

- Press the **CH1 to CH4(2)**, **Math1**, or **Math2** soft key to select the search target waveform.

- CH3, CH4, and Math2 are not displayed on the DL1720E.
- If you select a displayed waveform as a search target and select IN or OUT in step 7, the search zone (rectangular frame) is displayed.

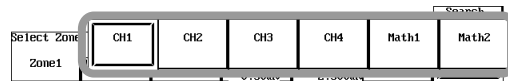

### Setting the Range of the Search Zone

- Press the **Upper/Lower** soft key to set the jog shuttle control to Upper, Lower, or both Upper and Lower.
  - If you select Upper, you can move the top edge of the zone.
  - If you select Lower, you can move the bottom edge of the zone.
  - If you select both Upper and Lower, you can move the position of the zone vertically without changing the spacing between the top and bottom edges of the zone. The value of the digit being specified by Upper changes.
- Turn the **jog shuttle** to set the top and bottom edges of the zone.
- Press the **Left/Right** soft key to set the jog shuttle control to Left, Right, or both Left and Right.
  - If you select Left, you can move the left edge of the zone.
  - If you select Right, you can move the right edge of the zone.
  - If you select both Left and Right, you can move the position of the zone horizontally without changing the spacing between the left and right edges of the zone. The value of the digit being specified by Left changes.

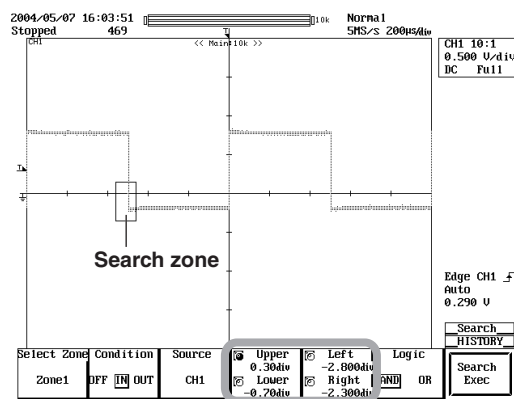

- Turn the **jog shuttle** to set the left and right edges of the zone.
- Repeat steps 5 to 13 to set Zone1 to Zone4.

### Selecting the Search Logic

- Press the **Logic** soft key to select AND or OR.

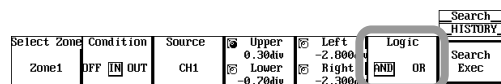

**Executing/Aborting the Search**

16. Press the **Search Exec** soft key. The search is executed, and the words Search Exec change to Search Abort.

To abort the search, press the **Search Abort** soft key. The search is aborted, and the words Search Abort change to Search Exec.

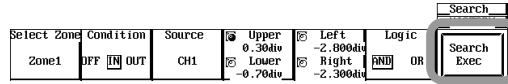

**Displaying the Found Waveform**

17. Press **ESC**. The screen returns to the HISTORY menu.

18. Display the waveform according to the procedure given in section 10.1.

The history map lists the record numbers and time stamps of the searched waveforms.

**Resetting the Search Results**

19. Set the Search Mode to OFF in the HISTORY menu, or turn OFF Zone1 to Zone4 and execute the search. The search result is reset.

**Explanation**

This section explains the setup procedures for searching history waveforms that pass or do not pass a specified search zone.

**Search Zone: Select Zone**

You can register up to four search zones, Zone1 to Zone4. For each search zone, you can set the search conditions below. You can also set whether to use AND or OR logic of the search conditions of the four search parameters to perform the search (see “Search Logic” described later).

- Status of the search parameter for the searched waveform
- Waveform to search
- Search zone range

**Status of the Search Parameter for the Searched Waveform: Condition**

You can select the condition of the target waveform to be searched in the search zone.

OFF: No search is performed.

IN: Searches waveforms that pass through the specified search zone. Also searches cases when the waveforms pass through the boundary lines.

OUT: Searches waveforms that do not pass through the specified search zone.

**Waveform to Search: Source**

You can select the search target waveform. If a waveform that meets the search condition is found, other history waveforms at the same time as the found waveform are also displayed.

- **For the DL1740E/DL1740EL**  
You can select the target waveform from CH1 to CH4, Math1, and Math2.
- **For the DL1720E**  
You can select from CH1 to CH2, and Math1.

## 10.2 Searching the History Waveforms Using Zones (History Search)

---

### Range of the Search Zone (Rectangular Frame)

You can set the top, bottom, left, and right edges of the search zone.

Top and Bottom Edges: The selectable range is  $\pm 4$  divisions, and the resolution is 0.01 divisions. The top edge (Upper) must be greater than or equal to the bottom edge (Lower)

Left and Right Edges: The selectable range is  $\pm 5$  divisions, and the resolution is ten divisions  $\div$  display record length. The right edge must be greater than or equal to the left edge. For a description of the display record length, see appendix 1.

### Search Logic

You can select the AND logic or OR logic of the search conditions of the four search parameters in performing the search.

AND: Searches for waveforms that meet all search conditions of Zone1 to Zone4.

OR: Searches for waveforms that meet one of the search conditions of Zone1 to Zone4.

### Search Range

You can search the history waveforms in the range specified by Start Rec and End Rec of the HISTORY menu (see section 10.1)

### Search Method

Search is performed in order from the newest history waveform.

### Post-Search History Map (Search Results)

The record numbers and time stamps of the waveforms that are found can be listed on the history map. If you set the Search Mode to OFF in the HISTORY menu, or turn OFF Zone1 to Zone4 and execute the search, the search result is reset.

### Note

---

If you wish to search for a computed waveform whose computation conditions were changed during or after waveform acquisition, you must first change the display mode to All.

---

# 10.3 Searching the History Waveforms Using Automatic Measurement of Parameters (History Search)

<For a description of this function, refer to page 2-23.>

## Procedure

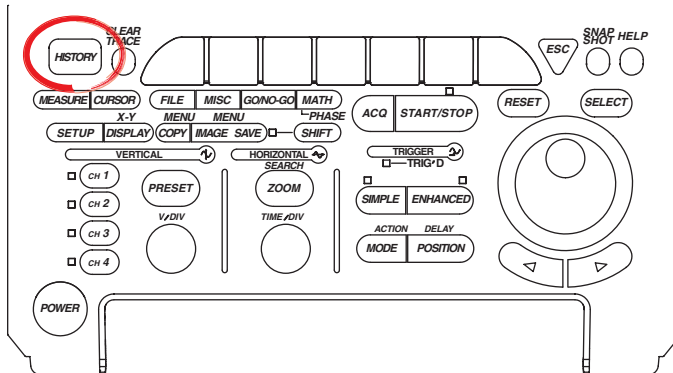

- To exit the menu during operation, press **ESC** located above the soft keys.
- For a description of the operation using a USB keyboard or a USB mouse, see section 4.3.

1. Press **HISTORY**. The HISTORY menu appears.
2. Press the **Search Mode** soft key. The Search Mode menu appears.

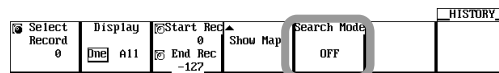

3. Press the **Parameter** soft key.

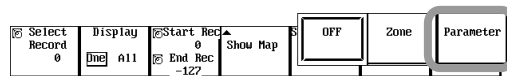

### Setting the Search Parameters and Search Conditions

4. Press the **Search Setup** soft key. The Search Setup menu appears.

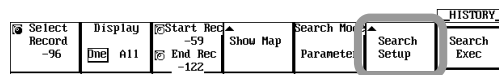

### Selecting the Parameters for Registering Search Conditions

5. Press the **Select Param** soft key. The Select Param menu appears.

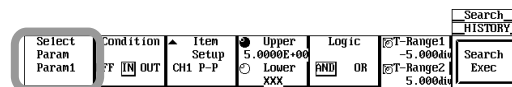

6. Press any of the **Param1** to **Param4** soft keys to select the parameter in which search conditions are to be registered.

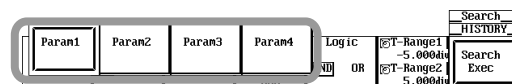

### Selecting the Condition of the Waveform to Search in the Search Parameters

7. Press the **Condition** soft key to select OFF, IN, or OUT.

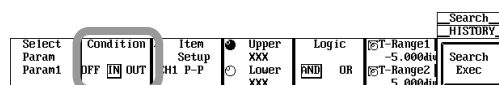



### 10.3 Searching the History Waveforms Using Automatic Measurement of Parameters (History Search)

#### Selecting the Search Target Waveform/Search Measurement Item

- Press the **Item Setup** soft key. The Item Setup dialog box opens.

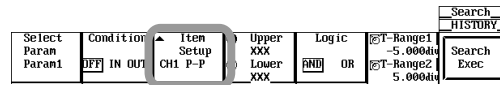

- Press the **CH1 to CH4(2)**, **Math1**, or **Math2** soft key to select the search target waveform.

CH3, CH4, and Math2 are not displayed on the DL1720E.

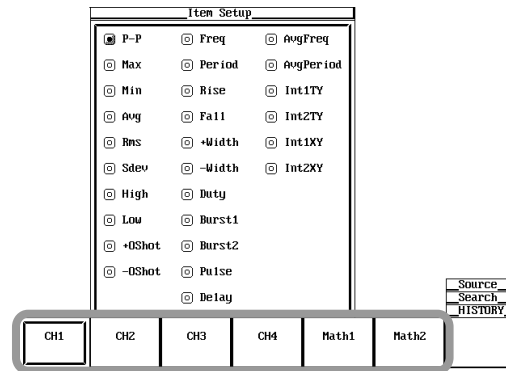

- Turn the **jog shuttle** to select the measurement parameter to be used as a search condition.
- Press **SELECT**. The mark to the left of the measurement parameter is highlighted. The measurement item whose mark to the left of the item is highlighted is the measurement item used as a search condition. You can set one measurement parameter to one search parameter.
- Press **ESC**. The Item Setup dialog box closes.

#### Setting the Determination Range of the Measured Value of the Search Measurement Parameter

- Press the **Upper/Lower** soft key to set the jog shuttle control to Upper or Lower.
  - If you select Upper, you can move the upper limit of the determination range.
  - If you select Lower, you can move the lower limit of the determination range.

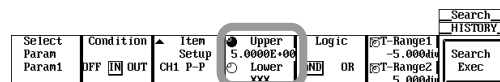

- Turn the **jog shuttle** to set the upper and lower limits of the determination range.
- Repeat steps 5 to 14 to set Param1 to Param4.

#### Selecting the Search Logic

- Press the **Logic** soft key to select AND or OR.

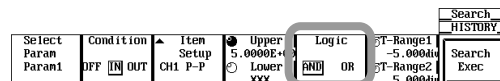

## 10.3 Searching the History Waveforms Using Automatic Measurement of Parameters (History Search)

### Setting the Search Range

17. Press the **T-Range1/T-Range2** soft key to set the jog shuttle control to T-Range1, T-Range2, or both T-Range1 and T-Range 2.
  - If you select T-Range1, you can set the left edge of the search range.
  - If you select T-Range2, you can set the right edge of the search range.
  - If you select both T-Range1 and T-Range2, you can move the search range without changing the spacing between the two. The value of the digit being specified by T-Range1 changes.
18. Turn the **jog shuttle** to set the search range.

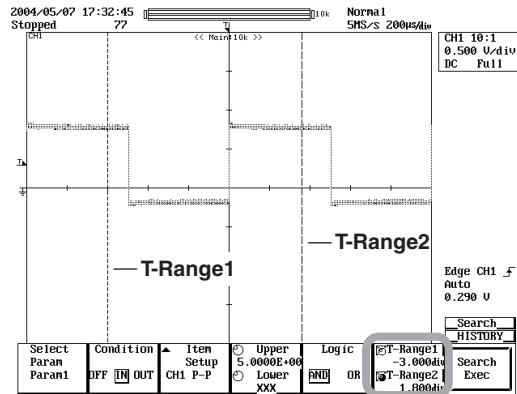

### Executing/Aborting the Search

19. Press the **Search Exec** soft key. The search is executed, and the words Search Exec change to Search Abort.  
To abort the search, press the **Search Abort** soft key. The search is aborted, and the words Search Abort change to Search Exec.

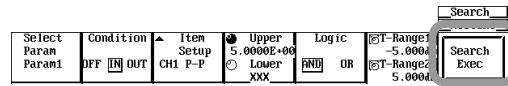

### Displaying the Searched Waveform

20. Press **ESC**. The screen returns to the HISTORY menu.
21. Display the waveform according to the procedure given in section 10.1.  
The history map lists the record numbers and time stamps of the searched waveforms.

### Resetting the Search Results

22. Set the Search Mode to OFF in the HISTORY menu, or turn OFF Param1 to Param4 and execute the search. The search result is reset.

## 10.3 Searching the History Waveforms Using Automatic Measurement of Parameters (History Search)

---

### **Explanation**

This section explains the setup procedures for searching history waveforms that meet or do not meet the specified search parameter conditions.

#### **Search Parameters**

You can register up to four search parameters, Param1 to Param4. For each search parameter, you can set the search conditions below. You can also set whether to use AND or OR logic of the search conditions of the four search parameters to perform the search (see "Search Logic" described later).

- Status of the search parameter for the searched waveform
- Target waveform/search measurement item
- Determination range of the measured value of the search measurement parameter
- Search range

#### **Status of the Search Parameters for the Searched Waveform: Condition**

You can select from the following.

OFF: No search is performed.

IN: Searches for waveforms whose measured value of the search and measurement parameter is within the determination range of the specified search parameter. Search is also made on boundary values.

OUT: Searches for waveforms whose measured value of the search and measurement parameter is not within the determination range of the specified search parameter.

#### **Selecting the Search Target Waveform/Search Measurement Item**

You can select the target waveform and the measurement parameter to be used as a search condition. If a waveform that meets the search condition is found, other history waveforms at the same time as the found waveform are also displayed.

#### **Waveform to Search**

- **For the DL1740E/DL1740EL**  
You can select the target waveform from CH1 to CH4, Math1, and Math2.
- **For the DL1720E**  
You can select from CH1 to CH2, and Math1.

#### **Search Measurement Items**

Same as the measurement parameters of the automated measurement of waveform parameters. See section 10.6.

#### **Determination Range of the Measured Value of the Search Measurement Parameter**

You can set the upper and lower limits of the determination range. The selectable range is  $-9.9999\text{E}+30$  to  $9.9999\text{E}+30$ . The upper limit (Upper) must be greater than or equal to the lower limit (Lower)

#### **Search Logic**

You can select the AND logic or OR logic of the search conditions of the four search parameters in performing the search.

AND: Searches for waveforms that meet all search conditions of Param1 to Param4.

OR: Searches for waveforms that meet one of the search conditions of Param1 to Param4.

#### **Search Range: T-Range1/T-Range2**

The selectable range is  $\pm 5$  divisions, and the resolution is ten divisions  $\div$  display record length. The right end of the search range (T-Range2) must be greater than or equal to the left end of the search range (T-Range1).

---

### 10.3 Searching the History Waveforms Using Automatic Measurement of Parameters (History Search)

#### History Waveform Range

You can search the history waveforms in the range specified by Start Rec and End Rec of the HISTORY menu (see section 10.1)

#### Search Method

Search is performed in order from the newest history waveform.

#### Post-Search History Map (Search Results)

The record numbers and time stamps of the waveforms that are found can be listed on the history map. If you set the Search Mode to OFF in the HISTORY menu, or turn OFF Param1 to Param4 and execute the search, the search result is reset.

#### Note

---

If you wish to search for a computed waveform whose computation conditions were changed during or after waveform acquisition, you must first change the display mode to All.

---

# 10.4 Searching Waveforms Using the Search and Zoom Function

<For a description of this function, refer to page 2-24.>

## Procedure

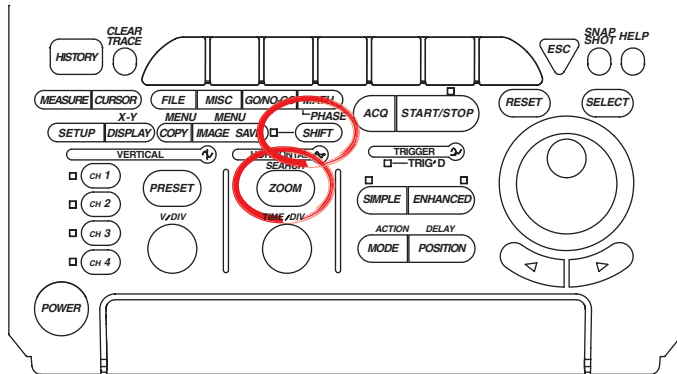

- To exit the menu during operation, press **ESC** located above the soft keys.
- In the procedural explanation below, the term **jog shuttle & SELECT** refers to the operation of selecting/setting items and entering values using the **jog shuttle** and **SELECT** and **RESET** keys. For details on this operation, see sections 4.1 and 4.2.
- For a description of the operation using a USB keyboard or a USB mouse, see section 4.3.

When waveform acquisition is stopped, you can search the displayed waveforms (within the display record length, see appendix 1) and display the waveforms that match the search conditions expanded on the screen.

The following five search modes are available. For the setup procedures of each type, see the pages indicated below.

- Edge -> Page 10-14
- Serial pattern -> Page 10-16
- Parallel pattern -> Page 10-18
- Pulse width -> Page 10-20
- Auto scroll -> Page 10-22

## Edge Search

1. Press **SHIFT+ZOOM (SEARCH)**. The SEARCH menu appears.

### Selecting the Search Method

2. Press the **Type** soft key. The Type menu appears.

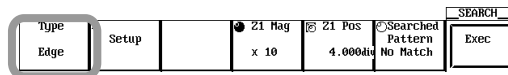

3. Press the **Edge** soft key.

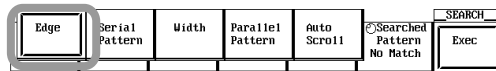

### Setting the Search Condition

4. Press the **Setup** soft key. The Setup dialog box opens.

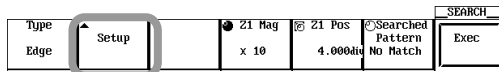

**Setting the Search Target Waveform, Level, Slope, and Hysteresis for Detecting Edges**

5. Use **jog shuttle & SELECT** to select the search target waveform (Source box).
6. Use **jog shuttle & SELECT** to set the level for detecting the edge (Level box).
7. Use **jog shuttle & SELECT** to select which slope edge, rising or falling, is to be detected (Polarity box).
8. Use **jog shuttle & SELECT** to set the hysteresis (width of the level for detecting the edge, Hysteresis box).

**Setting the Edge Detection Count and the Search Start Point**

9. Use **jog shuttle & SELECT** to set the edge detection count (Count box).
10. Use **jog shuttle & SELECT** to set the search start point (Start Point box).
11. Press **ESC**. The Setup dialog box closes.

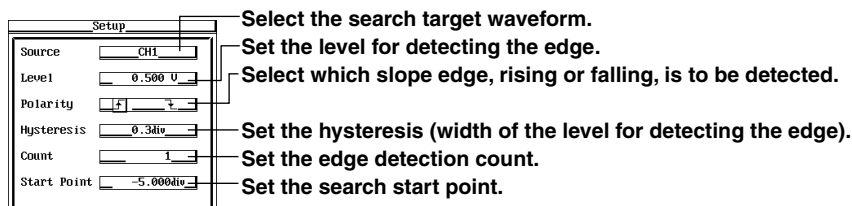

**Selecting the Window for Displaying the Searched Waveform (Zoom Waveform Display Frame)**

This menu appears only when the zoom waveform display mode is set to Z1&Z2 or Main&Z1&Z2. For all other modes, the menu does not appear, because the selection is not necessary.

12. Press the **Result Window** soft key to select Z1 or Z2.

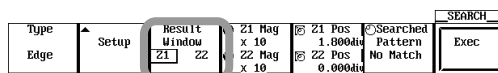

**Executing/Aborting the Search**

13. Press the **Exec** soft key. The search is executed, and the word Exec changes to Abort. Each time a waveform that matches the search condition is detected, the search is aborted, and the word Abort changes to Exec. To abort the search, press the **Abort** soft key. The search is aborted, and the word Abort changes to Exec.

When a waveform that matches the search condition is detected, the zoom box moves to that position and the zoom waveform display frame (the zoom waveform display frame selected in step 12 if the zoom waveform display mode is Z1&Z2 or Main&Z1&Z2) shows the detected waveform zoomed.

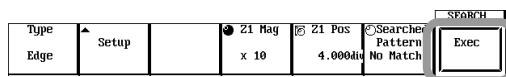

14. To search the next waveform using the same search condition, repeat step 13. The search can be repeated to the right edge of the screen or up to 1000 detections.

## 10.4 Searching Waveforms Using the Search and Zoom Function

### Redisplaying the Detected Waveforms

15. Press the **Searched Pattern** soft key.
16. Turn the **jog shuttle** to select the number (same as the detection count) of the detected waveform to be displayed. The zoom box moves to the position of the detected waveform of the selected number, and the zoom waveform display frame (the zoom waveform display frame selected in step 12 if the zoom waveform display mode is Z1&Z2 or Main&Z1&Z2) shows the detected waveform zoomed. The numbers get larger as the detected waveforms become newer (detected waveforms to the right have larger numbers than those to the left).

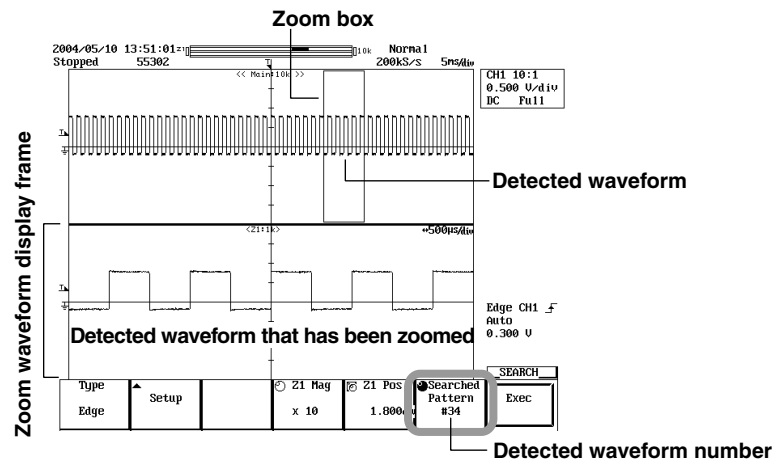

### Changing the Zoom Rate and Zoom Position of the Detected Waveforms

17. Change the zoom rate and zoom position of the waveform according to the procedures given in section 8.4.

### Serial Pattern (Serial Status Pattern) Search

1. Press **SHIFT+ZOOM (SEARCH)**. The SEARCH menu appears.

#### Selecting the Serial Pattern Search Method

2. Press the **Type** soft key. The Type menu appears.

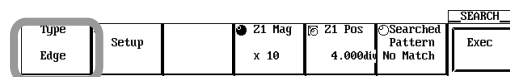

3. Press the **Serial Pattern** soft key.

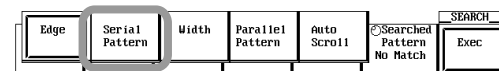

#### Setting the Search Condition

4. Press the **Setup** soft key. The Setup dialog box opens.

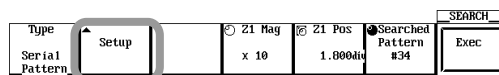

**Setting the Timing for Detecting the Status Pattern**

5. Use **jog shuttle & SELECT** to select None (detect the patterns at a certain interval), or a channel from CH1 to CH4(2) (synchronize to the selected channel signal, Clock CH box).
  - If you select None, proceed to step 6.
  - If you select CH1 to CH4(2), proceed to step 7.

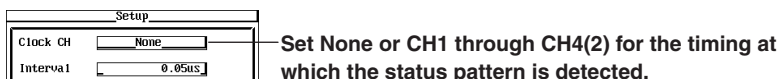

• **Setting the Interval for Detecting Patterns (When None Is Selected)**

6. Use **jog shuttle & SELECT** to set the interval for detecting the pattern (Interval box). Proceed to step 10.

**When Clock CH is set to None**

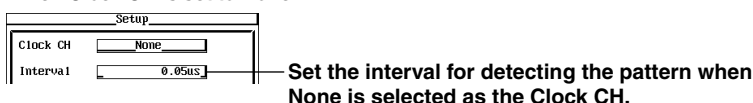

• **Setting the Detection Slope, Level, and Hysteresis of the Selected Synchronization Clock Signal (When CH1 to CH4(2) Is Selected)**

7. Use **jog shuttle & SELECT** to set the level for detecting the synchronization clock (Level box).
8. Use **jog shuttle & SELECT** to select the slope, rising or falling, for detecting the synchronization clock (Polarity box).
9. Use **jog shuttle & SELECT** to set the hysteresis (width of the level for detecting the synchronization clock, Hysteresis box).

**When Clock CH is set to CH1 to CH4 (2)**

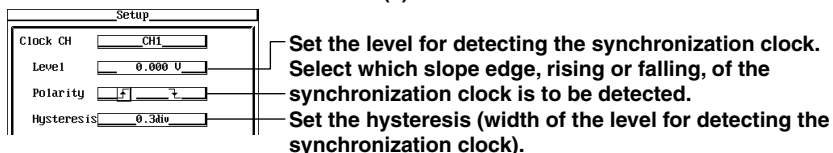

**Setting the Search Target Waveform and Level for Determining Statuses**

10. Use **jog shuttle & SELECT** to select the search target waveform (Source box).
11. Use **jog shuttle & SELECT** to set the level used to determine whether the status is high (Thr Upper box).
12. Use **jog shuttle & SELECT** to set the level used to determine whether the status is low (Thr Lower box).
  - When the search target waveform exceeds the specified level (Thr Upper), it is determined to be high.
  - When the search target waveform is below the specified level (Thr Lower), it is determined to be low.
  - For a description of the determination of the status when the search target waveform is between the levels specified by Thr Upper and Thr Lower (including the Thr Upper and Thr Lower values), see the explanation given below.

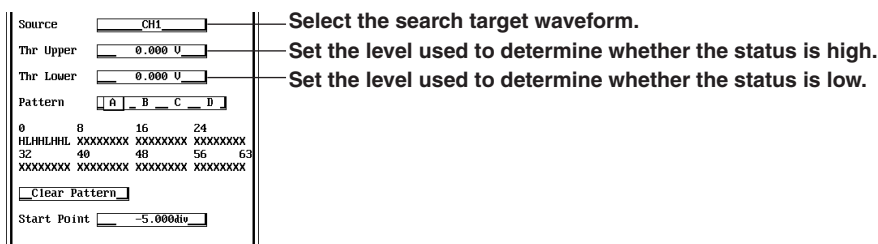



## 10.4 Searching Waveforms Using the Search and Zoom Function

### Setting the Status Determination Pattern and Search Start Point

13. Use **jog shuttle & SELECT** to select the preset status determination pattern of sixty-four points from A to D (Pattern box).
14. As necessary, use **jog shuttle & SELECT** to change the status determination pattern A to D by selecting the status of points 0 to 63 from H, L, and X. If Clear Pattern is executed using jog shuttle & SELECT, all points are set to X.
15. Use **jog shuttle & SELECT** to set the search start point (Start Point box).

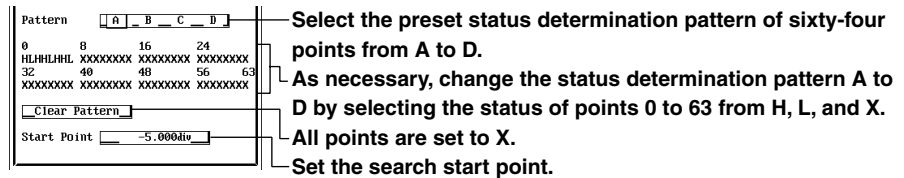

16. Press **ESC**. The Setup dialog box closes.

### Selecting the Window for Displaying the Searched Waveform (Zoom Waveform Display Frame)

17. The procedure is the same as step 12 on page 10-15.

### Executing/Aborting the Search

18. The procedure is the same as step 13 and 14 on page 10-15.

### Redisplaying the Detected Waveforms

19. The procedure is the same as step 15 and 16 on page 10-16.

### Changing the Zoom Rate and Zoom Position of the Detected Waveforms

20. Change the zoom rate and zoom position of the waveform according to the procedures given in section 8.4.

## Parallel Pattern (Parallel Status Pattern) Search

1. Press **SHIFT+ZOOM (SEARCH)**. The SEARCH menu appears.

### Selecting the Parallel Pattern Search Method

2. Press the **Type** soft key. The Type menu appears.

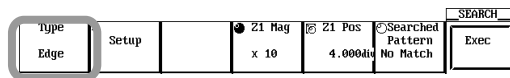

3. Press the **Parallel Pattern** soft key.



### Setting the Search Condition

4. Press the **Setup** soft key. The Setup dialog box opens.

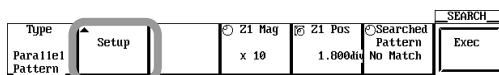

**Setting the Timing for Detecting the Status Pattern**

5. Use **jog shuttle & SELECT** to select None (detect the patterns of all waveforms), or a channel from CH1 to CH4(2) (synchronize to the selected channel signal and detect the patterns of all other waveforms, Clock CH box).
  - If you select None, proceed to step 9.
  - If you select CH1 to CH4(2), proceed to step 6.

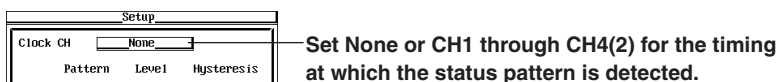

**Setting the Detection Slope, Level, and Hysteresis of the Selected Synchronization Clock Signal (When CH1 to CH4(2) Is Selected)**

6. Use **jog shuttle & SELECT** to select the slope, rising or falling, for detecting the synchronization clock (Pattern box).
7. Use **jog shuttle & SELECT** to set the level for detecting the synchronization clock (Level box).
8. Use **jog shuttle & SELECT** to set the hysteresis (width of the level for detecting the synchronization clock, Hysteresis box).

**When Clock CH is set to CH1 to CH4 (2)**

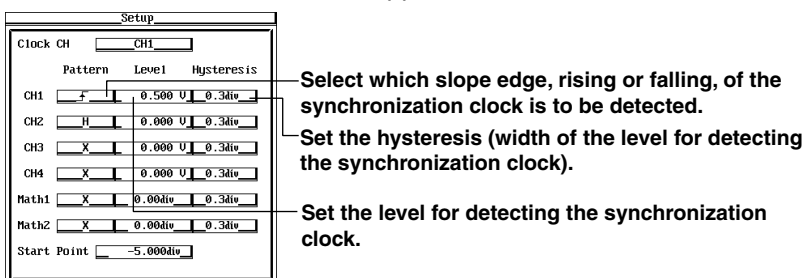

**Setting the Determination Pattern, Level, and Hysteresis of the Status of Waveforms (CH and Math) Other Than the Waveform of the Channel Selected as the Synchronization Clock Signal**

9. Use **jog shuttle & SELECT** to select the status determination pattern from H, L, and X (Pattern box).
10. Use **jog shuttle & SELECT** to set the level for determining whether the status is high or low (Level box).
11. Use **jog shuttle & SELECT** to set the hysteresis (width of the level for detecting high or low) (Hysteresis box).
  - When the search target waveform exceeds the specified upper limit of hysteresis, it is determined to be high.
  - When the search target waveform is below the specified lower limit of hysteresis, it is determined to be low.
  - For a description of the determination of the status when the search target waveform is within the specified hysteresis (including the upper and lower limits of hysteresis), see the explanation given below.

**Set the status determination pattern/level/hysteresis for waveforms other than those on channels selected as synchronized clock signals (CH or Math).**

**Select a status of H, L, or X.**

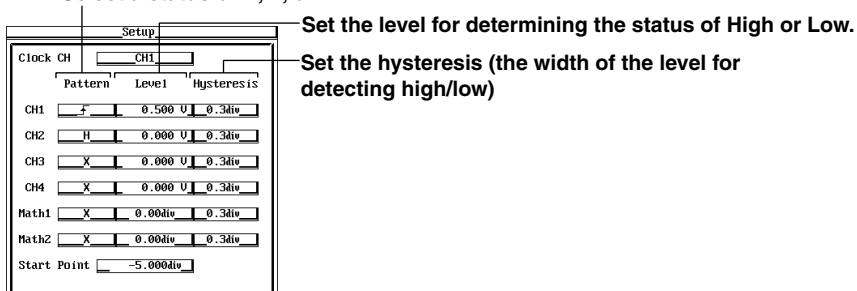

## 10.4 Searching Waveforms Using the Search and Zoom Function

### Setting the Search Start Point

- Use **jog shuttle & SELECT** to set the search start point (Start Point box).

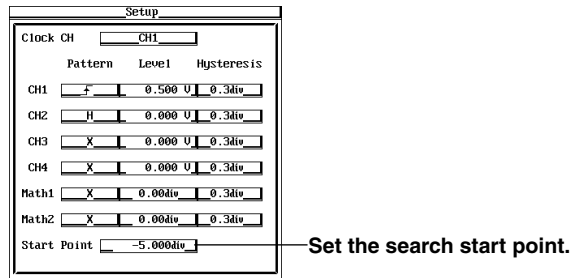

- Press **ESC**. The Setup dialog box closes.

### Selecting the Window for Displaying the Searched Waveform (Zoom Waveform Display Frame)

- The procedure is the same as step 12 on page 10-15.

### Executing/Aborting the Search

- The procedure is the same as step 13 and 14 on page 10-15.

### Redisplaying the Detected Waveforms

- The procedure is the same as step 15 and 16 on page 10-16.

### Changing the Zoom Rate and Zoom Position of the Detected Waveforms

- Change the zoom rate and zoom position of the waveform according to the procedures given in section 8.4.

## Pulse Width Search

- Press **SHIFT+ZOOM (SEARCH)**. The SEARCH menu appears.

### Selecting the Width Search Method

- Press the **Type** soft key. The Type menu appears.

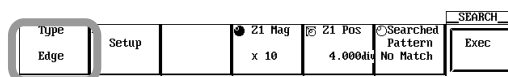

- Press the **Width** soft key.



### Setting the Search Condition

- Press the **Setup** soft key. The Setup dialog box opens.

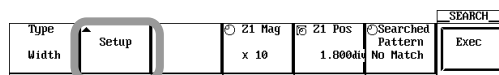

### Setting the Pulse Width Determination Type, Search Target Waveform, Level, Polarity, Hysteresis, Pulse Width, and Search Start Point

- Use **jog shuttle & SELECT** to select the determination type (Type box).
- Use **jog shuttle & SELECT** to select the search target waveform (Source box).
- Use **jog shuttle & SELECT** to set the level for determining whether the polarity is high or low (Level box).

8. Use **jog shuttle & SELECT** to select the polarity, high or low, used to perform determination (Polarity box).
9. Use **jog shuttle & SELECT** to set the hysteresis (width of the level for detecting the edge, Hysteresis box).
  - The interval from the point where the level of the search target waveform passes from below the specified lower limit of hysteresis to above and including the upper limit of hysteresis to the point where the level changes from above the specified upper limit of hysteresis to below and including the lower limit of hysteresis is determined to be the high pulse width.
  - The interval from the point where the level of the search target waveform passes from above the specified upper limit of hysteresis to below and including the lower limit of hysteresis to the point where the level changes from below the specified lower limit of hysteresis to above and including the upper limit of hysteresis is determined to be the low pulse width.
  - For the determination of the polarity when the change in the search target level does not apply to high or low conditions described above, see the explanation given later.
10. Use **jog shuttle & SELECT** to set the pulse width (determination time) used as the determination reference (Time box).
11. Use **jog shuttle & SELECT** to set the search start point (Start Point box).

When the determination type is set to Pulse<Time, Pulse>Time, or Time out

Select the search target waveform.

Set the level used to determine whether the polarity is high or low.

Select the polarity, high or low, used to perform determination.

Set the hysteresis (width of the level for detecting the edge).

Set the pulse width used as a determination reference.

Set the search start point.

When the determination type is T1<Pulse<T2.

Select the search target waveform.

Set the level used to determine whether the polarity is high or low.

Select the polarity, high or low, used to perform determination.

Set the hysteresis (width of the level for detecting the edge).

Set the pulse width used as a determination reference.

Set both the upper and lower limits of the time width.

Set the search start point.

12. Press **ESC**. The Setup dialog box closes.

#### Selecting the Window for Displaying the Searched Waveform (Zoom Waveform Display Frame)

13. The procedure is the same as step 12 on page 10-15.

#### Executing/Aborting the Search

14. The procedure is the same as step 13 and 14 on page 10-15.

#### Redisplaying the Detected Waveforms

15. The procedure is the same as step 15 and 16 on page 10-16.

#### Changing the Zoom Rate and Zoom Position of the Detected Waveforms

16. Change the zoom rate and zoom position of the waveform according to the procedures given in section 8.4.

## 10.4 Searching Waveforms Using the Search and Zoom Function

### Auto Scroll Search

1. Press **SHIFT+ZOOM (SEARCH)**. The SEARCH menu appears.

#### Selecting the Auto Scroll Search Method

2. Press the **Type** soft key. The Type menu appears.

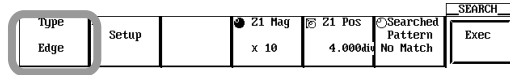

3. Press the **Auto Scroll** soft key.

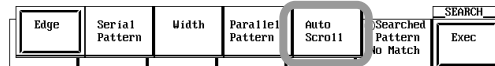

#### Setting the Auto Scroll Conditions

4. Press the **Direction** soft key to set the auto scroll direction to << or >>.
5. Press the **Speed** soft key.
6. Turn the **jog shuttle** to set the auto scroll speed.

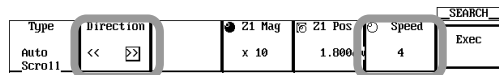

#### Selecting the Window for Displaying the Auto-Scrolled Waveform (Zoom Waveform Display Frame)

7. The procedure is the same as step 12 on page 10-15.

#### Executing/Aborting Auto Scroll

8. Press the **Exec** soft key. Auto scroll is executed, and the word Exec changes to Abort.

To abort auto scroll, press the **Abort** soft key. Auto scroll is aborted, and the word Abort changes to Exec.

When auto scroll is executed, the zoom box moves in the direction selected in step 4, and the zoom waveform display frame (the zoom waveform display frame selected in step 12 if the zoom waveform display mode is Z1&Z2 or Main&Z1&Z2) shows the waveform zoomed.



#### Changing the Zoom Rate and Zoom Position of the Detected Waveforms

9. Change the zoom rate and zoom position of the waveform according to the procedures given in section 8.4.

### Explanation

This section explains the setup procedures for searching the displayed waveforms (within the display record length, see appendix 1) and displaying the waveforms that match the search conditions expanded on the screen when waveform acquisition is stopped.

#### Search Method: Type

You can select from the following six search types.

- **Edge**

Search is performed on the number of times the waveform goes above or below (rising or falling) a specified level.

- **Serial Pattern**  
Search is performed on whether the serial status pattern of the waveform (status pattern of the waveform that changes over time) is the same as the pattern set using High (H), Low (L), and Don't Care (X).
- **Parallel Pattern**  
Search is performed on whether the parallel status pattern of the waveforms (status pattern of the waveforms at the same point) is the same as the pattern set using High (H), Low (L), and Don't Care (X).
- **Pulse Width**  
Search is performed on whether the pulse width of the waveform above or below a specified level is shorter or longer than the specified determination time.
- **Auto Scroll**  
The zoom position automatically moves (auto scroll) in the specified direction. You can confirm the zoomed waveform and stop the scroll operation at an arbitrary position.

### Edge Search Conditions

The following conditions can be specified.

#### Waveform to Search: Source

You can select the search target waveform.

- **For the DL1740E/DL1740EL**  
You can select the target waveform from CH1 to CH4, Math1, and Math2.
- **For the DL1720E**  
You can select from CH1 to CH2, and Math1.

#### Level

You can set the level for detecting the rising or falling edge. The selectable range is eight divisions within the screen. The resolution is 0.01 divisions.

#### Slope: Polarity

You can select which slope edge, rising or falling, is to be detected.

- ↗: Rising slope
- ↘: Falling slope

#### Hysteresis

You can set the hysteresis. The selectable range is 0.3 divisions to 4.0 divisions. The resolution is 0.one divisions.

- When the level of the search target waveform changes from below the specified lower limit of hysteresis to above and including the upper limit of hysteresis, it is detected as a rising edge.
- When the level of the search target waveform changes from above the specified upper limit of hysteresis to below and including the lower limit of hysteresis, it is detected as a falling edge.
- For all other cases, it is not detected as an edge.

#### Detection Count

- You can set the edge detection count. The available setting range is 1 to 1000000.
- If the search is aborted in the middle of the operation and the next search is resumed, the rising or falling edge of the previous detection position is counted as the 1st edge detection count.

### Search Start Point

You can set the search start point. The selectable range is  $\pm 5$  divisions. The resolution is ten division  $\div$  display record length. For a description of the display record length, see appendix 1.

### Example of an Edge Search

When the edge is set to rising and the detection count is set to 2

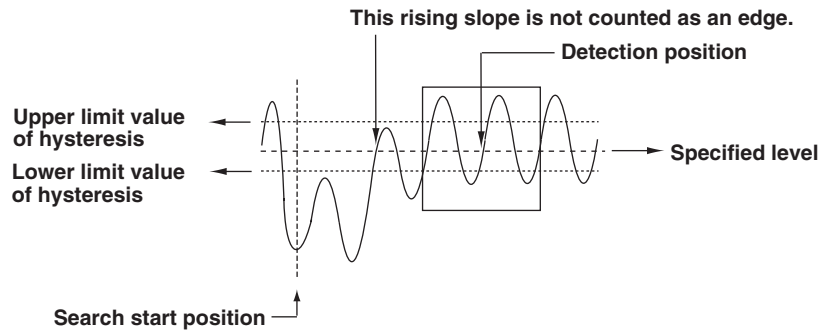

### Serial Pattern Search Conditions

The following conditions can be specified.

#### Clock Channel: Clock CH

Detects the status pattern in sync with the selected clock signal (clock channel).

- **For the DL1740E/DL1740EL**  
You can select from CH1 to CH4, and None.
- **For the DL1720E**  
You can select from CH1 to CH2, and None.

#### When the Clock Channel Is Set to None

##### • Detection Interval

You can set the interval for detecting the pattern.

#### When the Clock Channel Is Set to CH1 to CH4(2)

You can set the detection level, slope, and hysteresis of the selected synchronization clock signal.

##### • Level

You can set the level for detecting the synchronization clock. The selectable range is eight divisions within the screen. The resolution is 0.01 divisions.

##### • Slope: Polarity

You can select which slope edge, rising or falling, of the synchronization clock is to be detected.

- ↗: Rising slope
- ↘: Falling slope

##### • Hysteresis

You can set the hysteresis. The selectable range is 0.3 divisions to 4.0 divisions. The resolution is 0.one divisions.

- When the level of the search target waveform changes from below the specified lower limit of hysteresis to above and including the upper limit of hysteresis, it is detected as a synchronization clock.
- When the level of the search target waveform changes from above the specified upper limit of hysteresis to below and including the lower limit of hysteresis, it is detected as a synchronization clock.
- For all other cases, it is not detected as a synchronization clock.

**Waveform to Search: Source**

You can select the search target waveform.

- **For the DL1740E/DL1740EL**  
You can select the target waveform from CH1 to CH4, Math1, and Math2.
- **For the DL1720E**  
You can select from CH1 to CH2, and Math1.

**Level for Determining Status: Thr Upper/Thru Lower**

You can set the level for determining the status of the search target waveform. The selectable range is eight divisions within the screen. The resolution is 0.01 divisions. The resolution is 0.01 V/div. Thr Upper must be greater than or equal to Thr Lower.

- **Level for Determining High (Thr Upper)**  
You can set the level for determining the high status. When the search target waveform exceeds the specified level, it is determined to be high.
- **Level for Determining Low (Thr Lower)**  
You can set the level for determining the low status. When the search target waveform is below the specified level, it is determined to be low.
- **Between Thr Upper and Thr Lower**  
The status when the search target waveform is between the levels specified by Thr Upper and Thr Lower (including the Thr Upper and Thr Lower values) (A and B in the figure below) is determined to be the same status (true) as the status at the same point of the determination pattern specified on the next page and is handled as a section where the search condition is met.

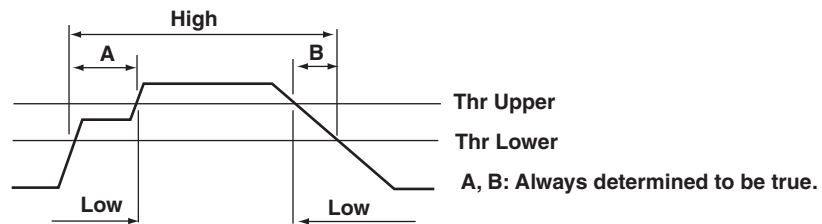

**Status Determination Pattern**

You can set four types, A to D, of status determination patterns. The status of sixty-four points can be specified using the H (High), L (Low), and X (Don't Care) designations.

- H: Status When Thru Upper Is Exceeded
- L: Status When Thr Lower is Not Reached
- X: No determination.

\* If you execute Clear Pattern, all sixty-four points are set to Xs.



## 10.4 Searching Waveforms Using the Search and Zoom Function

### Search Start Point

You can set the search start point. The selectable range is  $\pm 5$  divisions. The resolution is ten division  $\div$  display record length. For a description of the display record length, see appendix 1.

However, when Clock CH is set to None, the start point for searches is defined as follows.

- Taking the first rising or falling edge located to the right of the specified Start Point on the screen as the reference point, the search start point is set to the point 1/2 the specified interval to the right of the reference point.

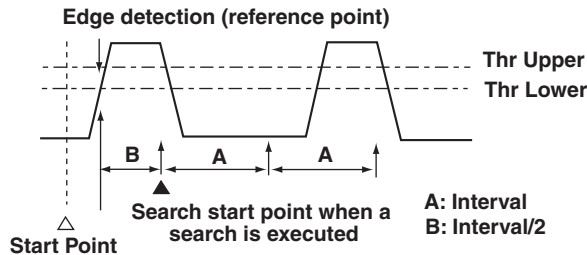

- When the interval between the Start Point and the search start position defined above is greater than the detection interval, the search start point is set by moving the point back by intervals specified by Interval so that the interval between the Start Point and the search start point is within Interval and the Start Point is not exceeded (the search start point shall not be to the left of the Start Point on the screen).

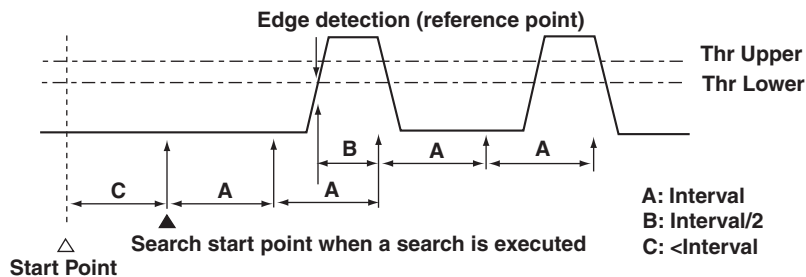

- Rising and falling edges are not detected in the hysteresis range (including the upper and lower limits of hysteresis) of the Clock CH.

### Parallel Pattern Search Conditions

The following conditions can be specified.

#### Clock Channel

Detects the status pattern in sync with the selected clock signal (clock channel).

- **For the DL1740E/DL1740EL**  
You can select from CH1 to CH4, and None.
- **For the DL1720E**  
You can select from CH1 to CH2, and None.

#### When the Clock Channel Is Set to None

The status patterns of all waveforms are determined.

**When the Clock Channel Is Set to CH1 to CH4(2)**

You can set the detection slope, level, and hysteresis of the selected synchronization clock signal.

- **Slope**

You can select which slope edge, rising or falling, of the synchronization clock is to be detected.

↗: Rising slope

↘: Falling slope

- **Level**

You can set the level for detecting the synchronization clock. The selectable range is eight divisions within the screen. The resolution is 0.01 divisions.

- **Hysteresis**

You can set the hysteresis. The selectable range is 0.3 divisions to 4.0 divisions. The resolution is 0.one divisions.

- When the level of the search target waveform changes from below the specified lower limit of hysteresis to above and including the upper limit of hysteresis, it is detected as a synchronization clock.
- When the level of the search target waveform changes from above the specified upper limit of hysteresis to below and including the lower limit of hysteresis, it is detected as a synchronization clock.
- For all other cases, it is not detected as a synchronization clock.

**Waveform to Search**

The search target waveforms are all the waveforms that are not selected as the clock channel. For each waveform, you can set the determination status (Pattern) and the level and hysteresis for determining the status.

- **Determination Status**

The status of each waveform can be specified using the H (High), L (Low), and X (Don't Care) symbols.

H: Status When Thru Upper Is Exceeded

L: Status When Thr Lower is Not Reached

X: No determination.

- **Level**

You can set the level used to determine whether the status is high or low. The selectable range is eight divisions within the screen. The resolution is 0.01 divisions.

- **Hysteresis**

You can set the hysteresis. The selectable range is 0.3 divisions to 4.0 divisions. The resolution is 0.one divisions.

- When the search target waveform exceeds the specified upper limit of hysteresis, it is determined to be high.
- When the search target waveform is below the specified lower limit of hysteresis, it is determined to be low.
- The status when the search target waveform is within the specified hysteresis (including the upper and lower limits of hysteresis), A and B in the figure below) is determined to be the same status (true) as the determination status (Pattern) described two sections earlier, and is handled as a level where the search condition is met.

**Search Start Point**

You can set the search start point. The selectable range is  $\pm 5$  divisions. The resolution is ten division  $\div$  display record length. For a description of the display record length, see appendix 1.

**Pulse Width Search Conditions**

The following conditions can be specified.

**Determination Type**

You can select the type used to determine the relationship between the pulse width of the search target waveform and the specified determination time.

- Pulse<Time: Searches the section where the pulse width of the search target waveform is shorter than the specified determination time.
- Pulse>Time: Searches the section where the pulse width of the search target waveform is longer than the specified determination time.
- T1<Pulse<T2: Searches the section where the pulse width of the search target waveform is within the range of the specified determination time.
- Time Out: Searches the section where the pulse width of the search target waveform exceeds the specified determination time. The displayed position in the zoom display differs from the Pulse>Time case.

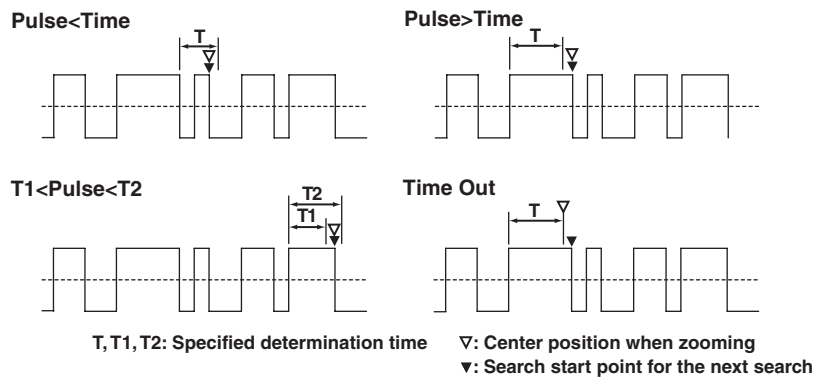

**Search Target Waveform**

You can select the search target waveform.

- **For the DL1740E/DL1740EL**  
 You can select the target waveform from CH1 to CH4, Math1, and Math2.
- **For the DL1720E**  
 You can select from CH1 to CH2, and Math1.

**Level**

You can set the level used to determine whether the polarity of the search target waveform is high or low. The selectable range is eight divisions within the screen. The resolution is 0.01 divisions.

**Polarity**

You can select the polarity, high or low, used to perform determination.

- High: Uses the pulse width of the waveform that is greater than or equal to the specified level (including the hysteresis condition) in the determination.
- Low: Uses the pulse width of the waveform that is less than or equal to the specified level (including the hysteresis condition) in the determination.

### Hysteresis

You can set the hysteresis. The selectable range is 0.3 divisions to 4.0 divisions. The resolution is 0.1 divisions.

- The interval from the point where the level of the search target waveform passes from below the specified lower limit of hysteresis to above and including the upper limit of hysteresis to the point where the level changes from above the specified upper limit of hysteresis to below and including the lower limit of hysteresis is determined to be the high pulse width.
- The interval from the point where the level of the search target waveform passes from above the specified upper limit of hysteresis to below and including the lower limit of hysteresis to the point where the level changes from below the specified lower limit of hysteresis to above and including the upper limit of hysteresis is determined to be the low pulse width.
- When the change in the search target level does not apply to high or low conditions described above, it is not detected as a high or low pulse width.

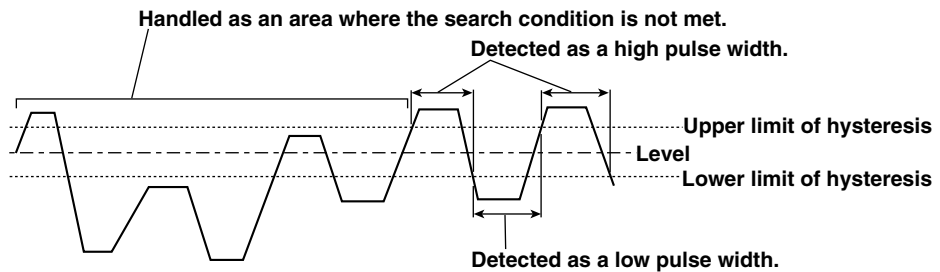

### Determination Time: Time, Time1/Time2

You can set the time used as a determination reference. The value specified here and the pulse width detected by the specified search condition are compared, and determination is made as to whether the result matches the selected type. The selectable range is (1/sample rate) to the display range. For a description of the sample rate, see appendix 1.

### Search Start Point

You can set the search start point. The selectable range is  $\pm 5$  divisions. The resolution is ten division  $\div$  display record length. For a description of the display record length, see appendix 1.

## Auto Scroll Search Conditions

The following conditions can be specified.

When auto scroll is in progress, you can only set the direction and speed of the auto scroll operation.

### Auto Scroll Direction

You can select the auto scroll direction.

<<: The zoom box automatically scrolls to the left. It can scroll up to the left end of the screen.

>>: The zoom box automatically scrolls to the right. It can scroll up to the right end of the screen.

### Speed

You can set the auto scroll speed. The available setting range is 1 to 7. The larger the value, the faster the scrolling.

### Window for Displaying the Found Waveform

When the zoom waveform display mode is Z1&Z2 or Main&Z1&Z2, you can select the zoom waveform display frame, Z1 or Z2, where the waveforms that are found are to be displayed. For all other modes, the menu does not appear, because the selection is not necessary.

### Detection Count and Redisplay of the Detected Waveform

#### Detection Count

For serial pattern, parallel pattern, and pulse width searches, the search can be repeated using the same search conditions up to the right end of the screen or up to 1000 detections.

#### Redisplaying the Detected Waveforms

For serial pattern, parallel pattern, and pulse width searches, the waveforms detected in the past can be displayed.

#### Zoom Rate and Zoom Position of the Detected Waveforms

The detected waveforms are displayed in the zoom waveform display frame. The zoom rate and the zoom position of these waveforms can be changed. For a description of the procedure, see section 8.4.

#### Note

---

- Searching is not possible while waveform acquisition is in progress.
  - A search cannot be performed on the results of the power spectrum computation.
  - The search results become invalid when you perform the following operations.
  - When waveform acquisition is started.
  - When Search Setup is changed.
  - When the phase of the search target waveform (Source) or synchronization clock signal (Clock CH) is shifted.
  - When the computation settings are changed.
  - Searching is not possible in interleave mode when Clock CH is set to multiple channels.
  - Searching is not possible if all the patterns are set to X.
  - Only the patterns of waveforms that are displayed are searched.
  - In the determination of serial pattern search, the points between Thr Upper and Thr Lower are always determined as True (match the specified status). If such points are included at the time the status pattern is detected, this fact is displayed as a message.
  - Points within the hysteresis (including the upper and lower limits of the hysteresis) in the determination when using the parallel pattern for the search are always determined as True (match the specified determination status). If such points are included, this fact is displayed as a message.
-

# 10.5 Cursor Measurements

<For a description of this function, refer to page 2-27.>

## Procedure

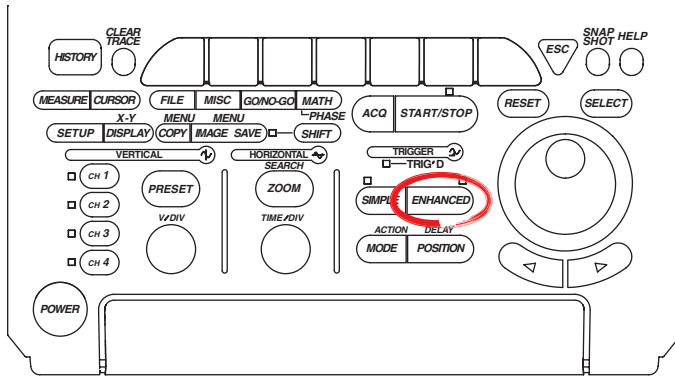

- To exit the menu during operation, press **ESC** located above the soft keys.
- In the procedural explanation below, the term **jog shuttle & SELECT** refers to the operation of selecting/setting items and entering values using the **jog shuttle** and **SELECT** and **RESET** keys. For details on this operation, see sections 4.1 and 4.2.
- For a description of the operation using a USB keyboard or a USB mouse, see section 4.3.

## Measuring Waveforms Using Horizontal Cursors

- Press **CURSOR**. The CURSOR menu appears.

### Selecting the Horizontal Cursor

- Press the **Type** soft key. The Type menu appears.



- Press the **Horizontal** soft key.

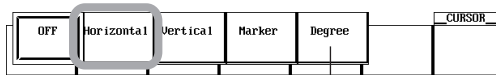

When X-Y waveforms are displayed, Degree is not available.

### Selecting the Waveform to Measure

- When X-Y Waveforms Are Not Displayed

- Press the **Trace** soft key. The Trace menu appears.

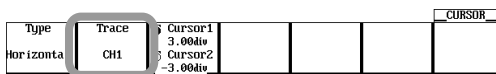

- Press the **CH1 to CH4(2)**, **Math1**, or **Math2** soft key to select the waveform to measure.

- On the DL1740E/DL1740EL, you can select from CH1 to CH4, Math1, and Math2.
- On the DL1720E, you can select CH1, CH2, and Math1.

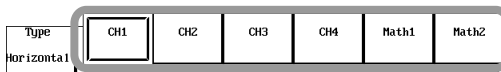

- When X-Y Waveforms Are Displayed

- Press the **Trace** soft key to select XY1 or XY2. Proceed to step 6.

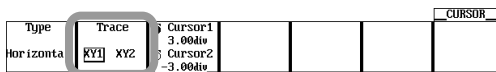

**Moving Cursors**

6. Press the **Cursor1/Cursor2** soft key to set the jog shuttle control to Cursor1, Cursor2, or both Cursor1 and Cursor2.
  - Select Cursor1 to move Cursor1.
  - Select Cursor2 to move Cursor2.
  - If you select both Cursor1 and Cursor2, you can move Cursor1 and Cursor2 vertically without changing the spacing between the two. The value of the digit being specified by Cursor1 changes.

When X-Y waveforms are not displayed.



When X-Y waveforms are displayed.



7. Turn the **jog shuttle** to move the cursor.

**Measuring Waveforms Using Vertical Cursors**

1. Press **CURSOR**. The CURSOR menu appears.

**Selecting the Vertical Cursor**

2. Press the **Type** soft key. The Type menu appears.

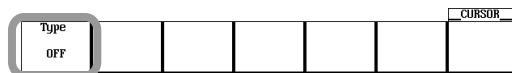

3. Press the **Vertical** soft key.



When X-Y waveforms are displayed, Degree is not available.

**Selecting the Waveform to Measure**

• **When X-Y Waveforms Are Not Displayed**

4. Press the **Trace** soft key. The Trace menu appears.



5. Press the **All, CH1 to CH4(2), Math1, or Math2** soft key to select the waveform to measure.

- On the DL1740E/DL1740EL, you can select from All, CH1 to CH4, Math1, and Math2.
- On the DL1720E, you can select All, CH1, CH2, and Math1.



• **When X-Y Waveforms Are Displayed**

4. Press the **Trace** soft key to select XY1 or XY2.  
Proceed to step 6.

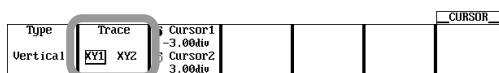

**Moving Cursors**

- Press the **Cursor1/Cursor2** soft key to set the jog shuttle control to Cursor1, Cursor2, or both Cursor1 and Cursor2.
  - Select Cursor1 to move Cursor1.
  - Select Cursor2 to move Cursor2.
  - If you select both Cursor1 and Cursor2, you can move Cursor1 and Cursor2 horizontally without changing the spacing between the two. The value of the digit being specified by Cursor1 changes.

When X-Y waveforms are not displayed.



When X-Y waveforms are displayed.



- Turn the **jog shuttle** to move the cursor.

**Jumping the Cursor to the Zoom Waveform Display Frame (When X-Y Waveforms Are Not Displayed)**

- Press the **Cursor Jump** soft key. The Cursor Jump menu appears.



- Press the **C1 to Z1**, **C1 to Z2**, **C2 to Z1**, or **C2 to Z2** soft key to select the cursor and the jump destination.



- Press the **Jump Exec** soft key. The cursor jumps to the specified zoom waveform display frame.



**Measuring Waveforms Using Marker Cursors**

- Press **CURSOR**. The CURSOR menu appears.

**Selecting the Marker Cursor**

- Press the **Type** soft key. The Type menu appears.



- Press the **Marker** soft key.



When X-Y waveforms are displayed, Degree is not available.



**Selecting the Waveform to Measure**

• **When X-Y Waveforms Are Not Displayed**

4. Press the **Select** soft key to select the marker from M1 to M4.

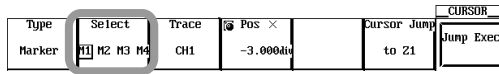

5. Press the **Trace** soft key. The Trace menu appears.

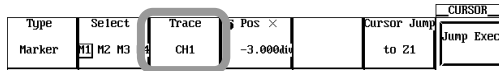

6. Press the **CH1 to CH4(2), Math1, or Math2** soft key to select the waveform to measure.

- On the DL1740E/DL1740EL, you can select from CH1 to CH4, Math1, and Math2.
- On the DL1720E, you can select CH1, CH2, and Math1.

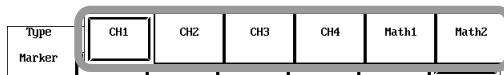

• **When X-Y Waveforms Are Displayed**

4. Press the **Trace** soft key to select XY1 or XY2.

Proceed to step 7.

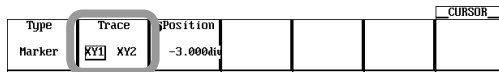

**Moving Cursors**

7. Turn the **jog shuttle** to move the cursor. The Position value changes.

**When X-Y waveforms are not displayed.**



**When X-Y waveforms are displayed.**



**Jumping the Cursor to the Zoom Waveform Display Frame (When X-Y Waveforms Are Not Displayed)**

8. Press the **Cursor Jump** soft key. The Cursor Jump menu appears.

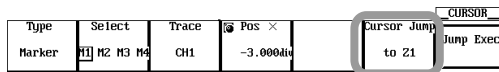

9. Press the **to Z1** or **to Z2** soft key to select the jump destination of the cursor.

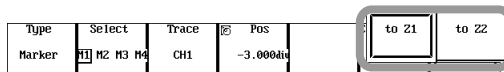

10. Press the **Jump Exec** soft key. The cursor jumps to the specified zoom waveform display frame.

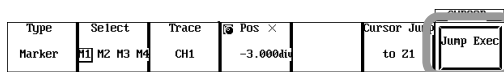

### Measuring Waveforms Using Angle Cursors (When X-Y Waveforms Are Not Displayed)

1. Press **CURSOR**. The CURSOR menu appears.

#### Selecting the "Degree" Angle Cursor

2. Press the **Type** soft key. The Type menu appears.

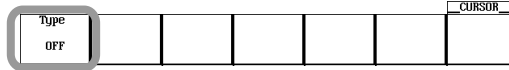

3. Press the **Degree** soft key.

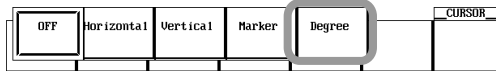

#### Selecting the Waveform to Measure

4. Press the **Trace** soft key. The Trace menu appears.

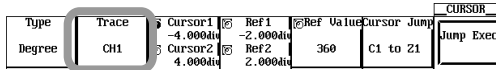

5. Press the **All, CH1 to CH4(2), Math1, or Math2** soft key to select the waveform to measure.
  - On the DL1740E/DL1740EL, you can select from All, CH1 to CH4, Math1, and Math2.
  - On the DL1720E, you can select All, CH1, CH2, and Math1.

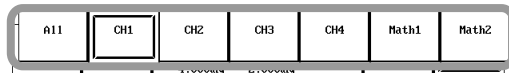

#### Setting the Cursor, Reference Cursor, and Reference Angle

##### • Moving Cursors

6. Press the **Cursor1/Cursor2** soft key to set the jog shuttle control to Cursor1, Cursor2, or both Cursor1 and Cursor2.
  - Select Cursor1 to move Cursor1.
  - Select Cursor2 to move Cursor2.
  - If you select both Cursor1 and Cursor2, you can move Cursor1 and Cursor2 horizontally without changing the spacing between the two. The value of the digit being specified by Cursor1 changes.

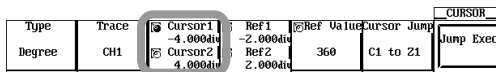

7. Turn the **jog shuttle** to move the cursor.

##### • Moving Reference Cursors

8. Press the **Ref1/Ref2** soft key to set the jog shuttle control to Ref1, Ref2, or both Ref1 and Ref2.
  - Select Ref1 to move Ref1.
  - Select Ref2 to move Ref2.
  - If you select both Ref1 and Ref2, you can move Ref1 and Ref2 horizontally without changing the spacing between the two. The value of the digit being specified by Ref1 changes.

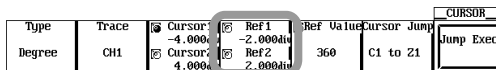

9. Turn the **jog shuttle** to move the reference cursor.

## 10.5 Cursor Measurements

- **Setting the Reference Angle**

10. Press the **Ref Value** soft key.

Type	Trace	Cursor1	Ref1	Ref Value	Cursor Jump	CURSOR
Degree	CH1	-4.000d	-2.000d	360	C1 to Z1	Jump Exec
		4.000d	2.000d			

11. Turn the **jog shuttle** to set the reference angle.

### Jumping the Cursor to the Zoom Waveform Display Frame

12. Press the **Cursor Jump** soft key. The Cursor Jump menu appears.

Type	Trace	Cursor1	Ref1	Ref Value	Cursor Jump	CURSOR
Degree	CH1	-4.000d	-2.000d	360	C1 to Z1	Jump Exec
		4.000d	2.000d			

13. Press the **C1 to Z1**, **C1 to Z2**, **C2 to Z1**, or **C2 to Z2** soft key to select the cursor and the jump destination.

Type	Trace	Cursor1	C1 to Z1	C1 to Z2	C2 to Z1	C2 to Z2
Degree	CH1	-4.000d				
		4.000d				

14. Press the **Jump Exec** soft key. The cursor jumps to the specified zoom waveform display frame.

Type	Trace	Cursor1	Ref1	Ref Value	Cursor Jump	CURSOR
Degree	CH1	-4.000d	-2.000d	360	C1 to Z1	Jump Exec
		4.000d	2.000d			

### Explanation

This section explains the setup procedures for placing cursors on the displayed waveform (within the display record length, see appendix 1) and displaying various types of measured values at the cross point of the cursor and waveform. The following four types of cursors are available.

- Horizontal cursors
- Vertical cursors
- Marker cursors
- Angle cursors

### Limitations

Cursor measurements cannot be made on the following waveforms.

- Snapshot waveforms
- Accumulated waveforms (however, measurement is possible on the accumulated waveform acquired last).

### Cursor Measurement Parameters

The table below shows the parameters that can be measured and displayed using each type of cursors.

#### • When X-Y Waveforms Are Not Displayed

##### Horizontal cursors

Measures the Y-axis value at the cursor position.

Y1	Y-axis (vertical axis) value of Cursor1
Y2	Y-axis value of Cursor2
DY	The difference between the Y-axis values of Cursor1 and Cursor2

##### Vertical cursors

Measures the X-axis and Y-axis values at the cursor position.

X1	X-axis (vertical axis) value of Cursor1
X2	X-axis value of Cursor2
DX	The difference between the X-axis values of Cursor1 and Cursor2
1/DX	The inverse of the difference between the X-axis values of Cursor1 and Cursor2
Y1	Y-axis value at the cross point of Cursor1 and the waveform
Y2	Y-axis value at the cross point of Cursor2 and the waveform
DY	The difference between the Y-axis values of Cursor1 and Cursor2

##### Marker cursors

Measures the X-axis value and Y-axis value of the waveform. Marker cursors move along the waveform. M1 (Marker 1) to M4 (Marker 4) can be set on different waveforms.

X1-X4	X-axis values of M1 to M4
DX2	The difference between the X-axis values of M1 and M2
DX3	The difference between the X-axis values of M1 and M3
DX4	The difference between the X-axis values of M1 and M4
Y1-Y4	Y-axis values of M1 to M4
DY2	The difference between the Y-axis values of M1 and M2
DY3	The difference between the Y-axis values of M1 and M3
DY4	The difference between the Y-axis values of M1 and M4

##### Angle cursors (Degree)

Measurements can be made by converting the time axis values into angles. The zero point (position of reference cursor Ref1) and the end point (position of the reference cursor Ref2) are set on the X-axis and an angle (reference angle) is assigned to the width of Ref1 and Ref2. The positions of the two angle cursors (Cursor1 and Cursor2) are converted into angles from the specified reference angle and measured.

X1	Angle of Cursor1 from Ref1
X2	Angle of Cursor2 from Ref1
DX	The angle difference between Cursor1 and Cursor2
Y1	Y-axis value at the cross point of Cursor1 and the waveform
Y2	Y-axis value at the cross point of Cursor2 and the waveform
DY	The difference between the Y-axis values of Cursor1 and Cursor2
Setting Range of the Reference Angle	1-720°

#### • When X-Y Waveforms Are Displayed

##### Horizontal cursor: Measures the Y-axis value at the cursor position.

Y1	Y-axis value of Cursor1
Y2	Y-axis value of Cursor2
DY	The difference between the Y-axis values of Cursor1 and Cursor2

##### Vertical cursor: Measures the X-axis value at the cursor position.

X1	X-axis value of Cursor1
X2	X-axis value of Cursor2
DX	The difference between the X-axis values of Cursor1 and Cursor2

##### Marker cursor: Measures the X-axis value and Y-axis value of the waveform.

T	Time of the cursor from the trigger point
X	X-axis value of the cursor
Y	Y-axis value of the cursor

### Movement Range of Cursors

- **When X-Y Waveforms Are Not Displayed**

---

#### Horizontal cursors

The movement range is  $\pm 4$  divisions. The resolution is 0.01 divisions.

---

#### Vertical cursors, marker cursors, and angle cursors

The movement range is  $\pm 5$  divisions. The resolution is ten division  $\div$  display record length. For a description of the display record length, see appendix 1.

---

- **When X-Y Waveforms Are Displayed**

---

#### Horizontal cursors and vertical cursors

The movement range is  $\pm 4$  divisions. The resolution is 0.01 divisions.

---

#### Marker cursors

The movement range is  $\pm 5$  divisions. The resolution is ten division  $\div$  display record length. For a description of the display record length, see appendix 1.

---

### Jumping the Cursor to the Zoom Waveform Display Frame (When X-Y Waveforms Are Not Displayed)

You can jump M1 to M4 (marker cursors) and Cursor1 and Cursor2 (vertical cursors or angle cursors) to the zoom waveform display frame. The cursors can be jumped in the following manner.

- **Marker Cursors**

to Z1: Make the selected marker jump to the Z1 window.

to Z2: Make the selected marker jump to the Z2 window.

- **Vertical Cursors and Angle Cursors**

C1 to Z1: Make Cursor1 jump to the Z1 window.

C1 to Z2: Make Cursor1 jump to the Z2 window.

C2 to Z1: Make Cursor2 jump to the Z1 window.

C2 to Z2: Make Cursor2 jump to the Z2 window.

### Note

---

- The measured values of the X-axis (horizontal axis and time axis) are displayed relative to the trigger position.
  - If measurement is not possible, \*\*\* is displayed in the measured value display area.
  - When the T/div setting is not repetitive sampling mode and the acquisition mode is not averaging mode, sampled data may not exist at the vertical cursor position in the interpolation display1 area. The measured value of the vertical cursor in this case is the value of the sampled data closest to the cursor on the right. On the contrary, marker cursors always move over the sampled data.
    - \* Interpolation display is used when there are less than 500 points of sampled data in ten divisions along the X-axis or when the zoom waveform display format is Main&Z1&Z2 and there are less than 250 points of sampled data in the zoom waveform display frame.
-

# 10.6 Automated Measurement of Waveform Parameters

<For a description of this function, refer to page 2-28.>

## Procedure

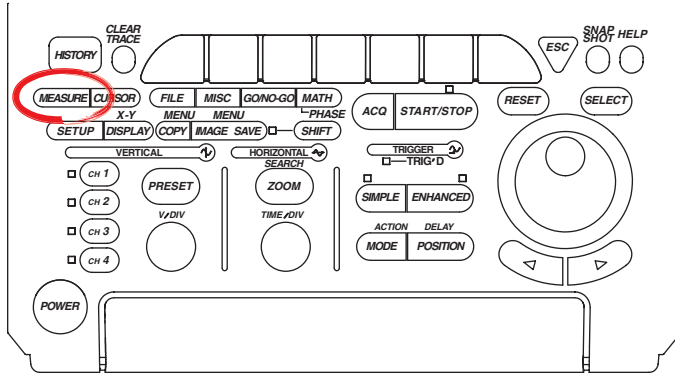

- To exit the menu during operation, press **ESC** located above the soft keys.
- In the procedural explanation below, the term **jog shuttle & SELECT** refers to the operation of selecting/setting items and entering values using the **jog shuttle** and **SELECT** and **RESET** keys. For details on this operation, see sections 4.1 and 4.2.
- For a description of the operation using a USB keyboard or a USB mouse, see section 4.3.

- Press **MEASURE**. The MEASURE menu appears.
- Press the **Mode** soft key. The Mode menu appears.

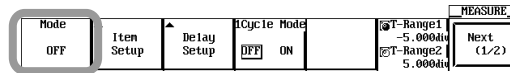

- Press the **ON** soft key.

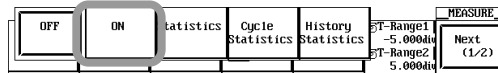

### Selecting the Measurement Item

- Press the **Item Setup** soft key. The Item Setup menu and Item Setup dialog box appear.

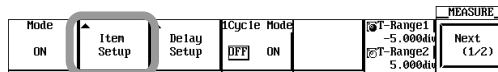

- Press the **CH1 to CH4(2), Math1, or Math2** soft key to select the waveform to measure.
  - On the DL1740E/DL1740EL, you can select from CH1 to CH4, Math1, and Math2.
  - On the DL1720E, you can select CH1, CH2, and Math1.

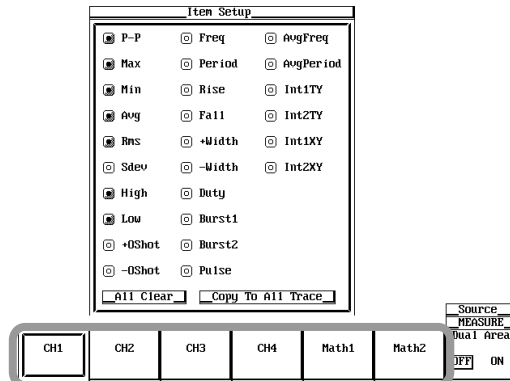

## 10.6 Automated Measurement of Waveform Parameters

6. Turn the **jog shuttle** to select the parameter to be measured.
7. Press **SELECT**. The mark to the left of the measurement parameter is highlighted.
  - The measurement parameter whose mark to the left of the parameter is highlighted is the parameter to be measured.
  - If you execute All Clear using **jog shuttle & SELECT**, all the highlighted displays are cleared, and all parameters are not measured.
  - If you execute Copy To All Trace using **jog shuttle & SELECT**, the settings in the current Item Setup dialog box are copied to the Item Setup dialog boxes of all waveforms.
8. Press **ESC**. The Item Setup dialog box closes.

### Setting the Delay Measurement between Waveforms

9. Press the **Delay Setup** soft key. The Delay Setup dialog box opens.



### Setting the Measurement Mode and Detection Conditions of the Waveform to Be Measured

10. Use **jog shuttle & SELECT** to select the measurement mode (Mode box).
11. Press the **CH1 to CH4(2)**, **Math1**, or **Math2** soft key to select the waveform to measure.
  - On the DL1740E/DL1740EL, you can select from CH1 to CH4, Math1, and Math2.
  - On the DL1720E, you can select CH1, CH2, and Math1.

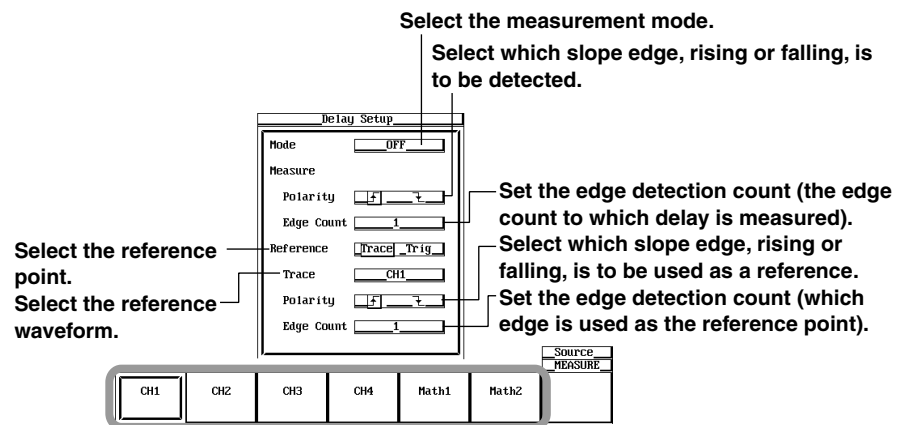

12. Use **jog shuttle & SELECT** to select which slope edge, rising or falling, of the waveform being measured is to be detected (Polarity box under Measure).
13. Use **jog shuttle & SELECT** to set the edge detection count (the edge count to which delay is measured, Edge Count box under Measure).

### Setting the Reference Point

14. Use **jog shuttle & SELECT** to select the reference point (Reference box).  
If you select Trig for the reference point, the succeeding steps are not necessary.
15. Use **jog shuttle & SELECT** to select the reference waveform (Trace box under Reference).
16. Use **jog shuttle & SELECT** to select which slope edge, rising or falling, of the reference waveform to be the reference (Polarity box under Reference).
17. Use **jog shuttle & SELECT** to set the edge detection count (the edge count to be the reference point, Edge Count box under Reference).
18. Press **ESC**. The Delay Setup dialog box closes.

**Turning 1 Cycle Mode ON and OFF**

19. Press the **1Cycle Mode** soft key to select ON or OFF.

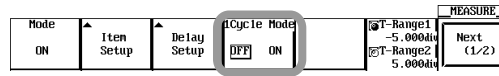

**Setting the Measurement Range**

20. Press the **T-Range1/T-Range2** soft key to set the jog shuttle control to T-Range1, T-Range2, or both T-Range1 and T-Range 2.

- If you select T-Range1, you can move T-Range1.
- If you select T-Range2, you can move T-Range2.
- If you select both T-Range1 and T-Range2, you can move T-Range1 and T-Range2 horizontally without changing the spacing between the two. The value of the digit being specified by T-Range1 changes.

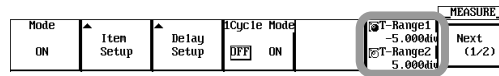

21. Turn the **jog shuttle** to set the measurement range.

**Setting the Distal, Mesial, and Proximal Values**

22. Press the **Next (1/2)** soft key. The page 2 menu appears.

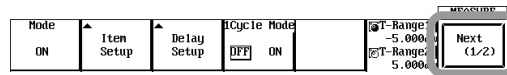

**Selecting the Waveform to Set**

23. Press the **Trace** soft key. The Trace menu appears.

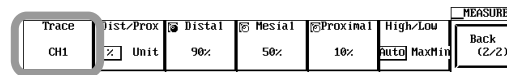

24. Press the **CH1 to CH4(2), Math1, or Math2** soft key to select the waveform to set.

- On the DL1740E/DL1740EL, you can select from CH1 to CH4, Math1, and Math2.
- On the DL1720E, you can select CH1, CH2, and Math1.

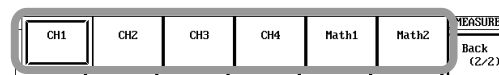

**Setting Distal, Mesial, and Proximal Unit and Values**

25. Press the **Dist/Prox Mode** soft key to select % or Unit.

- If you select %, you can set the distal, mesial, and proximal values in percentages by taking the high level and low level of the waveform to be set to be 100% and 0%, respectively.
- If you select Unit, you can set the distal, mesial, and proximal values in the range corresponding to V/div\_8 divisions within the screen.

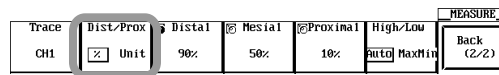

26. Press the **Distal** soft key. Distal becomes the item under jog shuttle control.

27. Turn the **jog shuttle** to set the distal value.

28. Press the **Mesial** soft key. Mesial becomes the item under jog shuttle control.

29. Turn the **jog shuttle** to set the mesial value.



## 10.6 Automated Measurement of Waveform Parameters

30. Press the **Proximal** soft key. Proximal becomes the item under jog shuttle control.
31. Turn the **jog shuttle** to set the proximal value.

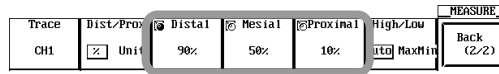

### Setting the High and Low Values

32. Press the **High/Low Mode** soft key to select Auto or MAX-MIN.
  - If you select Auto, the higher amplitude level is set to high and lower level is set to low by taking into account the frequency of occurrence of the voltage level of the waveform being measured within the measurement range and the effects of ringing and spikes.
  - If you select MAX-MIN, the maximum value (MAX) and minimum value (MIN) within the range are set to high and low values, respectively.

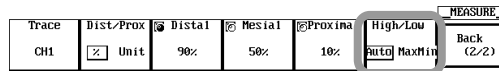

### Explanation

This section explains the setup procedures for performing automated measurement on various measurement parameters on the displayed waveform (within the display record length, see appendix 1). Up to 24000 data points of the results of automated measurements can be saved to a file (see section 12.8).

#### Limitations

Automated measurement of waveform parameters cannot be performed on the following waveforms.

- Snapshot waveforms
- Accumulated waveforms (however, measurement is possible on the accumulated waveform acquired last).

#### Automated Measurement Mode

The following modes are available in automated measurement of waveform parameters.

OFF: Automated measurement is not performed.

ON: Measures the specified parameters.

Statistics, Cycle Statistics, and History Statistics:

Performs statistical processing on the measured results of the specified parameters. See section 10.7.

#### Number of Measurement Parameters

Measurements can be made on twenty-six types of parameters and delay between waveforms. Up to 24000 data points of measurement parameters of all waveforms can be saved.

#### Number of Parameters That Can Be Displayed

Automated Measurement Mode	Number of Display Items
ON	Displays up to twelve parameters of all waveforms. The order in which the waveforms are listed is the same as the order in which the waveforms appear in the menu used to select the waveforms to be measured. The order in which the parameters are listed is the same as the order in which the parameters appear in the Item Setup dialog box.
Statistics	Displays up to two statistical values of the measurement parameters of all waveforms. The order in which the waveforms and parameters is listed is the same as the ON case.
Cycle Statistics	Same as Statistics.
History Statistics	Same as Statistics.

**Voltage-Axis Parameters**

- P-P: P-P value (Max – Min) [V]
- Max: Max Voltage [V]
- Min: Min Voltage [V]
- Rms: Rms value  $(1/\sqrt{n})(\sum(xi)^2)^{1/2}$  [V]
- Avg: Average voltage  $(1/n)\sum xi$  [V]
- Sdev: Standard deviation
- (SDv)\*:  $(1/n(\sum xi^2 - (\sum xi)^2/n))^{1/2}$
- OShot: Amount of undershoot
- (-vr)\*:  $(Low - Min)/(High - Low) \times 100$  [%]
- +OShot: Amount of overshoot
- (+Ovr)\*:  $(Max - High)/(High - Low) \times 100$  [%]
- High: High voltage [V]
- Low: Low voltage [V]

\* The characters inside the parentheses are measurement parameter names used when displaying the measured values.

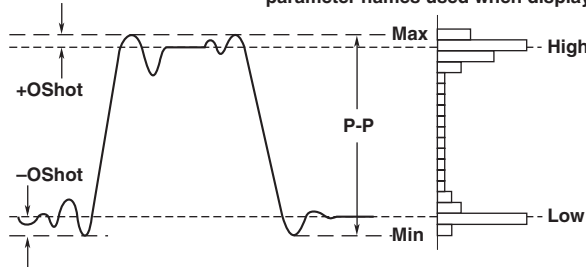

**Time-Axis Parameters**

- Rise: Rise time [s]
- Fall: Fall time [s]
- Freq: Frequency [Hz] 1/Period
- Period: Period [s]
- (Prod)\*
- AvgFreq: Average frequency within the measurement range [Hz]
- (FR-A)\*
- AvgPeriod: Average period within the measurement range [Hz]
- (PR-A)\*
- +Width: Time width above the mesial value [s]
- (+Wd)\*
- Width: Time width below the mesial value [s]
- (-Wd)\*
- Duty: Duty cycle + Width/Period  $\times 100$  [%]

\* The characters inside the parentheses are measurement parameter names used when displaying the measured values.

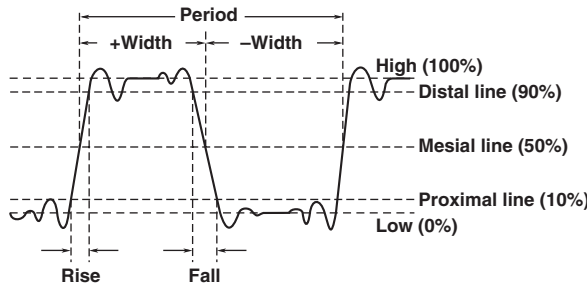

**Pulse: Pulse count (PlsN)**

Set the measurement range (Time Range) according to the pulse you wish to measure.

When Pulse=3

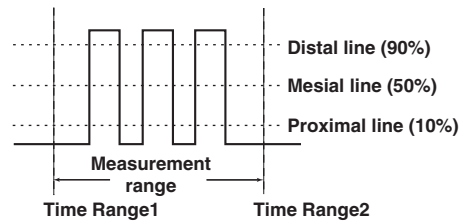

**Burst1, Burst2: Burst width [s] (Bst1, Bst2)**

Set the measurement range (Time Range) according to the burst width you wish to measure.

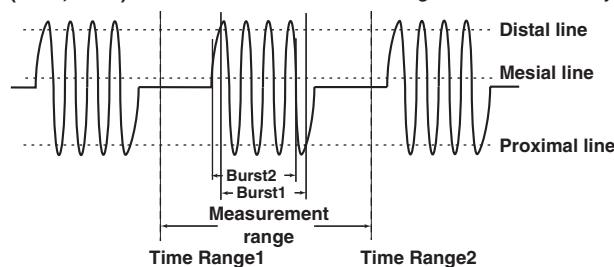

**Area Parameters**

Int1TY: The area under the positive amplitude

Int2TY: The area under the positive amplitude – the area under the negative amplitude

Int1XY: The summation of the triangular area of the X-Y waveform

Int2XY: The summation of the trapezoidal area of the X-Y waveform

\* For details on the derivation of the area, see appendix 2.

**Delay between Waveforms**

The time difference between the rising or falling edge between waveforms and the time difference from the trigger point to the rising or falling edge of waveforms can be measured.

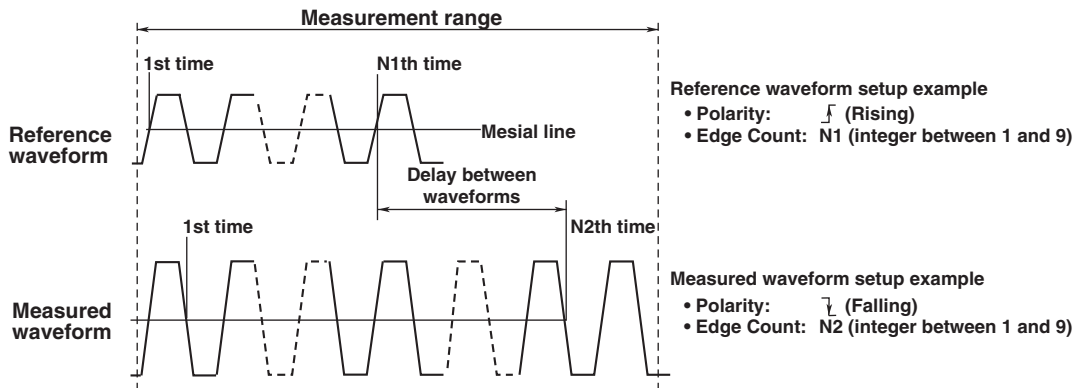

• **Measurement Mode**

You can select the measurement mode.

OFF: Delay between waveforms is not measured.

Time: Displays the delay between waveforms using time.

Degree: Displays the delay between waveforms using angles.

Converting equation  $\text{Angle} = \text{Delay (s)} / \text{Period (s)} \times 360 \text{ (deg)}$ . The period is that of a reference waveform.

• **Reference point**

You can select the reference point used when measuring the delay between waveforms.

Trace: The reference point is set to the edge of the reference waveform.

Trig: The reference point is set to the trigger position.

• **Slope: Polarity**

You can select which slope, rising or falling, of the waveform to be measured or reference waveform is to be detected.

$\uparrow$ : Rising slope

$\downarrow$ : Falling slope

• **Detection Count: Edge Count**

Set which edge (count) is to be the reference point or measurement point. The selectable range is an integer from 1 to 9.

• The level at the detection point is the mesial point.

• The measurement parameter name when displaying the measured value is Dly.

**1 Cycle Mode**

This mode is used determine the waveform cycle and calculate measurement values related to the vertical axis or area within the cycle. This mode is suited to measurement parameters such as Rms and Avg that produce errors depending on the measurement range. This mode does not affect the measurement parameters related to the time axis or the area of the X-Y waveforms.

**Measurement Range: T-Range1/T-Range2**

The selectable range is  $\pm 5$  divisions, and the resolution is ten divisions  $\div$  display record length. The right end of the measurement range (T-Range2) must be greater than or equal to the left end of the measurement range (T-Range1).

**Distal, Mesial, and Proximal Values**

You can select the method of assigning the three levels that are used as references in measurements such as the rise and fall times. The distal value must be greater than or equal to the mesial value, and the proximal value must be greater than or equal to the mesial value.

**%:** Taking the high and low levels to be 100% and 0%, respectively, you can set the distal, mesial, and proximal values of each waveform in the range of 0% to 100%. The resolution is 1%.

**Unit:** You can set the distal, mesial, and proximal values of each waveform in the range corresponding to  $V/\text{div} \times (8 \text{ divisions within the screen})$ . The resolution is 0.01 divisions.

**Method of Setting High and Low**

High indicates the 100% level in measurements such as the rise or fall time, and Low indicates the 0% level. You can select the method for setting High and Low.

**Auto:** The higher amplitude level is set to high and lower level is set to low by taking into account the frequency of occurrence of the voltage level of the waveform being measured within the measurement range and the effects of ringing and spikes. This method is best-suited when measuring rectangular waveforms and pulse waveforms.

**MAX-MIN:** The maximum value (MAX) and the minimum value (MIN) in the measurement range are set to high and low values, respectively. Applies to such waves as sine waves and saw tooth waves. It does not apply to waveforms with ringing or spikes.

**Note**

- If measurement is not possible, \*\*\* is displayed in the measured value display area.
- If the measurement mode is Degree and the reference point is Trig, \*\*\* is displayed in the measured value display area.
- For waveforms of small amplitude, correct measurements may not be possible.
- If there are two or more periods of waveform in the measurement range, the automatic measurement of Fall, Freq, Period, +Width, .Width, and Duty is performed on the first waveform.

# 10.7 Statistical Processing of the Automated Measurement Values of Waveform Parameters

<For a description of this function, refer to page 2-28.>

## Procedure

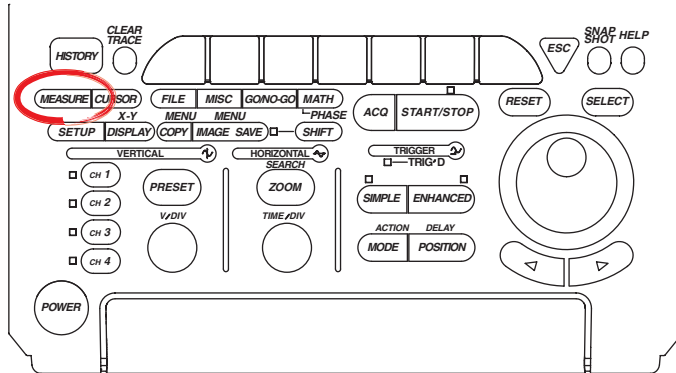

- To exit the menu during operation, press **ESC** located above the soft keys.
- For a description of the operation using a USB keyboard or a USB mouse, see section 4.3.

1. Press **MEASURE**. The MEASURE menu appears.
2. Press the **Mode** soft key. The Mode menu appears.

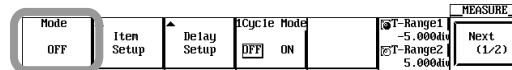

## Measuring Waveform Parameters and Performing Statistical Processing (Normal Statistical Processing)

3. Press the **Statistics** soft key. The waveforms are measured and statistical processing is performed. Then, statistics are displayed.



### Display example of statistics

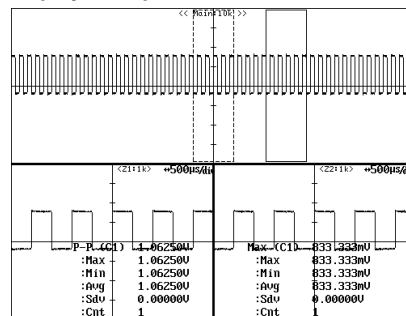

4. Perform the following setup procedures as necessary. For the operating procedure, see section 10.6.
  - Selecting the measurement parameters (steps 4 to 8 on page 10-39).
  - Setting the delay measurement between waveforms (steps 9 to 18 on page 10-40).
  - Turning ON/OFF 1 cycle mode (step 19 on page 10-41).
  - Setting the measurement range (steps 20 and 21 on page 10-41).
  - Setting distal, mesial, and proximal values (steps 22 to 31 on page 10-41).
  - Setting high and low values (step 32 on page 10-42).

### Measurement per Cycle and Statistical Processing within the Measurement Range

3. Press the **Cycle Statistics** soft key.



4. Perform the following setup procedures as necessary. For the operating procedure, see section 10.6.
  - Selecting the measurement parameters (steps 4 to 8 on page 10-39).
  - Setting the measurement range (steps 20 and 21 on page 10-41).
  - Setting distal, mesial, and proximal values (steps 22 to 31 on page 10-41).
  - Setting high and low values (step 32 on page 10-42).

#### Selecting the Waveform for Determining the Cycle

5. Press the **Cycle Trace** soft key. The Cycle Trace menu appears.

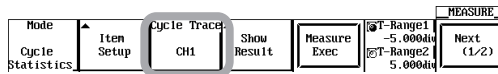

6. Press the **Own, CH1 to CH4(2), Math1, or Math2** soft key to select the waveform used to determine the cycle.
  - On the DL1740E/DL1740EL, you can select from Own, CH1 to CH4, Math1, and Math2.
  - On the DL1720E, you can select Own, CH1, CH2, and Math1.



#### Executing/Aborting Measurement per Cycle and Statistical Processing within the Measurement Range

7. Press the **START/STOP** key to stop waveform acquisition.
8. Press the **Measure Exec** soft key. Measurement per cycle and statistical processing within the measurement range are performed on the displayed waveform from the left end to the right end of the screen (from the oldest waveform). The words Measure Exec change to Measure Abort. To abort the measurement and statistical processing, press the **Measure Abort** soft key. The measurement and statistical processing are aborted, and the words Measure Abort change to Measure Exec.

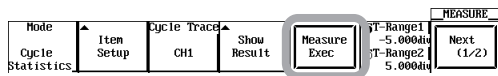

Statistical values display example

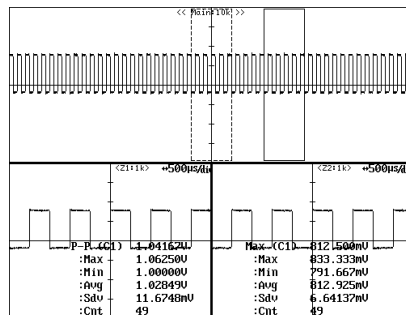

## 10.7 Statistical Processing of the Automated Measurement Values of Waveform Parameters

### Displaying Measured Values

- Press the **Show Result** soft key. The Measure Parameter List window appears and the measured values are listed.

Measured values with assigned numbers #00001, #00002, and so on are displayed in the measured order. The smallest assigned number corresponds to the measured value of the waveform at the left end of the screen (oldest waveform).

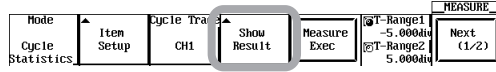

- List Scroll**

- Turn the **jog shuttle** to scroll the list up and down.

The Measure Parameter List window displays up to 25 measured values at once in the order of occurrence. By scrolling the list up and down using the jog shuttle, measured values beyond 25 data points can be displayed.

- Press the < or > key (arrow key) to scroll the list left and right.

The Measure Parameter List window displays up to four measurement parameters at once in the order of parameters that are specified to be measured in the Item Setup dialog box (see page 10-39). By scrolling the list left and right using < and >, measured parameters beyond four parameters can be displayed.

**Scroll left and right using < or >.**

← Measurement parameters →

Measure Parameter List

	P-P (C1)	Max (C1)	Min (C1)	Avg (C1)
#00001	1.02083U	812.500mV	↑-200.333mV	294.880mV
#00002	1.02083U	812.500mV	-200.333mV	↑ 297.471mV
#00003	1.02083U	812.500mV	-200.333mV	294.672mV
#00004	1.04167U	812.500mV	↓-229.167mV	295.398mV
#00005	1.04167U	812.500mV	-229.167mV	294.465mV
#00006	1.02083U	812.500mV	-200.333mV	293.636mV
#00007	1.04167U	812.500mV	-229.167mV	295.398mV
#00008	1.04167U	812.500mV	-229.167mV	293.843mV
#00009	1.02083U	812.500mV	-200.333mV	294.983mV
#00010	1.02083U	812.500mV	-200.333mV	295.007mV
#00011	1.02083U	812.500mV	-200.333mV	293.947mV
#00012	1.04167U	812.500mV	-229.167mV	294.776mV
#00013	1.04167U	↑ 833.333mV	-200.333mV	294.672mV
#00014	1.02083U	812.500mV	-200.333mV	296.124mV
#00015	1.02083U	812.500mV	-200.333mV	295.916mV
#00016	1.02083U	812.500mV	-200.333mV	293.947mV
#00017	1.02083U	812.500mV	-200.333mV	294.983mV
#00018	1.04167U	812.500mV	-229.167mV	294.983mV
#00019	1.04167U	812.500mV	-229.167mV	294.362mV

↑ Measured values

↓ Measured values

Max/Min  
Item1

Max/Min  
Item2

Max/Min  
Item3

Max/Min  
Item4

Utility

MEASURE

Sort

FWD

REV

• Searching the Maximum or Minimum Values of the Four Measurement Parameters Being Displayed

12. Press the **Max/Min Item1** soft key. The measured values of the 1st measurement parameter from the left of the list are searched, and the cursor (highlight) moves to the measured value with the maximum or minimum mark (↑ or ↓).
13. Press the **Max/Min Item2** soft key. The measured values of the 2nd measurement parameter from the left of the list are searched, and the cursor moves to the measured value with the maximum or minimum mark (↑ or ↓).
14. Likewise, press the **Max/Min Item3** and **Max/Min Item4** soft keys. The cursor moves to the corresponding measured values.

The cursor does not move if there is no maximum or minimum value.

Item1	Item2	Item3	Item4
Measure Parameter List			
P-P (C1)	Max (C1)	Min (C1)	Avg (C1)
#00001	1.02083U	812.500mV	↑-200.333mV
#00002	1.02083U	812.500mV	↑ 297.471mV
#00003	1.02083U	812.500mV	-200.333mV
#00004	1.04167U	812.500mV	↓-229.167mV
#00005	1.04167U	812.500mV	↓ 295.390mV
#00006	1.02083U	812.500mV	-200.333mV
#00007	1.04167U	812.500mV	-229.167mV
#00008	1.04167U	812.500mV	-229.167mV
#00009	1.02083U	812.500mV	-200.333mV
#00010	1.02083U	812.500mV	-200.333mV
#00011	1.02083U	812.500mV	-200.333mV
#00012	1.04167U	812.500mV	-229.167mV
#00013	1.04167U	↑ 833.333mV	-200.333mV
#00014	1.02083U	812.500mV	-200.333mV
#00015	1.02083U	812.500mV	-200.333mV
#00016	1.02083U	812.500mV	-200.333mV
#00017	1.02083U	812.500mV	-200.333mV
#00018	1.04167U	812.500mV	-229.167mV
#00019	1.04167U	812.500mV	-229.167mV

Utility  
MEASURE  
Sort  
FWD REV

Max/Min Item1   Max/Min Item2   Max/Min Item3   Max/Min Item4

Mark indicating the maximum value  
Mark indicating the minimum value

• Sorting the Measured Values in Ascending or Descending Order

15. Press the **Sort** soft key to select FWD or REV.

If FWD is selected, the measured values are sorted in ascending order (left to right on the screen).

Measure Parameter List			
P-P (C1)	Max (C1)	Min (C1)	Avg (C1)
#00001	1.02083U	812.500mV	↑-200.333mV
#00002	1.02083U	812.500mV	↑ 297.471mV
#00003	1.02083U	812.500mV	-200.333mV
#00004	1.04167U	812.500mV	↓-229.167mV
#00005	1.04167U	812.500mV	↓ 295.390mV
#00006	1.02083U	812.500mV	-200.333mV
#00007	1.04167U	812.500mV	-229.167mV
#00008	1.04167U	812.500mV	-229.167mV
#00009	1.02083U	812.500mV	-200.333mV
#00010	1.02083U	812.500mV	-200.333mV
#00011	1.02083U	812.500mV	-200.333mV
#00012	1.04167U	812.500mV	-229.167mV
#00013	1.04167U	↑ 833.333mV	-200.333mV
#00014	1.02083U	812.500mV	-200.333mV
#00015	1.02083U	812.500mV	-200.333mV
#00016	1.02083U	812.500mV	-200.333mV
#00017	1.02083U	812.500mV	-200.333mV
#00018	1.04167U	812.500mV	-229.167mV
#00019	1.04167U	812.500mV	-229.167mV

Utility  
Sort  
FWD REV

Max/Min Item1   Max/Min Item2   Max/Min Item3   Max/Min Item4

If REV is selected, the measured values are sorted in descending order (right to left on the screen).

Measure Parameter List			
P-P (C1)	Max (C1)	Min (C1)	Avg (C1)
#00049	1.04167U	812.500mV	-229.167mV
#00048	1.02083U	812.500mV	-200.333mV
#00047	1.02083U	812.500mV	-200.333mV
#00046	1.02083U	812.500mV	-200.333mV
#00045	1.02083U	812.500mV	-200.333mV
#00044	1.02083U	791.667mV	-229.167mV
#00043	1.04167U	812.500mV	-229.167mV
#00042	1.00000U	↑ 791.667mV	-200.333mV
#00041	1.02083U	812.500mV	-200.333mV
#00040	1.04167U	812.500mV	-229.167mV
#00039	1.02083U	812.500mV	-200.333mV
#00038	1.02083U	812.500mV	-200.333mV
#00037	1.02083U	812.500mV	-200.333mV
#00036	1.02083U	812.500mV	-200.333mV
#00035	1.02083U	812.500mV	-200.333mV
#00034	↑ 1.06250U	833.333mV	-229.167mV
#00033	1.02083U	812.500mV	-200.333mV
#00032	1.02083U	812.500mV	-200.333mV
#00031	1.02083U	812.500mV	-200.333mV

Utility  
Sort  
FWD REV

Max/Min Item1   Max/Min Item2   Max/Min Item3   Max/Min Item4



### Measurement and Statistical Processing of History Waveforms

3. Press the **History Statistics** soft key.

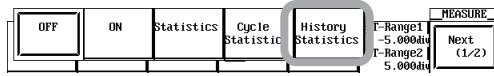

4. Perform the following setup procedures as necessary. For the operating procedure, see section 10.6.
  - Selecting the measurement parameters (steps 4 to 8 on page 10-39).
  - Setting the delay measurement between waveforms (steps 9 to 18 on page 10-40).
  - Setting the measurement range (steps 20 and 21 on page 10-41).
  - Setting distal, mesial, and proximal values (steps 22 to 31 on page 10-41).
  - Setting high and low values (step 32 on page 10-42).

### Executing/Aborting Measurement and Statistical Processing of History Waveforms

5. Press the **START/STOP** key to stop waveform acquisition.
6. Press the **Measure Exec** soft key. Measurement and statistical processing are executed on the history waveforms. The words Measure Exec change to Measure Abort.

To abort the measurement and statistical processing, press the **Measure Abort** soft key. The measurement and statistical processing are aborted, and the words Measure Abort change to Measure Exec.

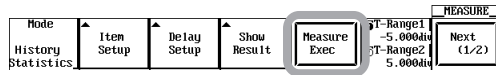

#### Statistical values display example

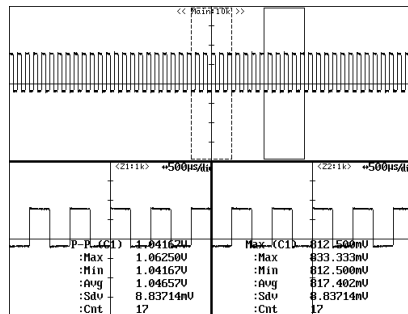

### Displaying Measured Values

7. The procedure is the same as steps 9 to 15 on page 10-48.

### Explanation

This section explains the setup procedures for performing measurement and statistical processing on the same measurement parameters as the automated measurement of waveform parameters. The following five statistics can be displayed on the measured values of two measurement parameters.

- Max: Maximum value
- Min: Minimum value
- Avg: Average value
- Sdv: Standard deviation
- Cnt: Number of measured values used in the statistical processing

For example, if you selected P-P of CH1 as a measurement parameter, the maximum, minimum, average, standard deviation, and the number of measured values used in the statistical processing of the P-P of CH1 are displayed.

### Target Waveform

The waveform on which measurement and statistical processing are performed is CH1 to CH4(2), Math1, or Math2. Statistical processing is performed on the measurement target waveform that was selected in section 10.6.

- \* On the DL1740E/DL1740EL, the waveform is CH1 to CH4, Math1, or Math2. On the DL1720E, you can select CH1, CH2, and Math1.

### Measurement Parameters on Which Statistical Processing Is Performed

- Measurement and statistical processing can be performed on the same measurement parameters as those of the automated measurement of waveform parameters.
- In the normal measurement and statistical processing and the measurement and statistical processing of history waveforms, statistical processing can be performed on the computed parameters of the automated measurement of waveform parameters on dual areas.
- The statistics that can be displayed are two parameters of the selected measurement parameters (see page 10-39) in either type of measurement and statistical processing. If you selected three or more measurement parameters, the first two parameters in the order of parameters that are specified to be measured (P-P, Max, Min, ... , Init1XY, and Init2XY) in the Item Setup dialog box (see page 10-39) from the smallest channel are displayed. For example, if you selected P-P of CH1, Min of CH2, and Max of CH3, P-P of CH1 and Min of CH2 are displayed. The statistics that are not displayed can be loaded into a PC using the communication function. For details, see the *Communication Interface User's Manual (IM701730-17E)*.

### Measurement Range

The measurement range is the same as the measurement range specified in the automated measurement of waveform parameters. See section 10.6 or 10.8.

### Methods of Measurement and Statistical Processing

The following three types of measurement and statistical processing are available.

#### Normal Measurement and Statistical Processing

Measurement and statistical processing of the selected measurement parameters are performed on all acquired waveforms while acquiring waveforms.

- If you stop waveform acquisition and start it again, measurement and statistical processing continues from where it left off.
- Measurement and statistical processing are performed on the selected measurement parameters that are not displayed. Therefore, if you disable the measurement and statistical processing of a displayed measurement parameter while waveform acquisition is in progress, the statistics of the next selected measurement parameter in line to be displayed are displayed. The number of measured values used in the measurement and statistical processing (Cnt) is the number of measured values measured up to that point.
- If you add measurement and statistical processing on a new measurement parameter while waveform acquisition is in progress or when it is stopped, the number of measured values used in the measurement and statistical processing (Cnt) is the number of measured values measured since the parameter was added.

#### Measurement per Cycle and Statistical Processing within the Measurement Range

The cycle of the displayed waveform is determined in order from the oldest data, the selected parameters for automated measurement are measured on the data within the cycle, and statistical processing is performed. The cycle is determined in the same fashion as the Period for the waveform parameter. You can select whether to apply the cycle of the specified waveform to all waveforms or determine the cycle for each waveform. Measurement and statistical processing can be performed on a single history waveform selected by Select Record. For the procedure of selecting history waveforms, see section 10.1.

## 10.7 Statistical Processing of the Automated Measurement Values of Waveform Parameters

---

### CH1 to CH4 (2), Math1, Math2

Performs automated measurement of waveform parameters on all target waveforms per cycle of the specified channel, and performs statistical processing. You can select up to CH2 and Math1 on the DL1720E and up to CH4 and Math2 and Math2 on the DL1740E/DL1740EL, respectively.

---

### Own

Determines the cycle for each target waveform, performs automated measurement of waveform parameters for each cycle, and performs statistical processing. However, if signals of different cycles are applied to multiple channels, automated measurement of waveform parameters and statistical processing are performed for the number of cycles of the channel whose cycle is the slowest on all other channels.

---

- **The following parameters cannot be measured.**
- 

### Waveform Used to Determine the Cycle

(If you selected "Own" for the method of determining the cycle described earlier, all the waveforms are "waveforms used to determine the cycle").

Avg Freq (average frequency), Avg Period (average period), Pulse (pulse count), Int1XY (area), Int2XY (area), and Delay.

---

### Other Waveforms

Int1XY (area), Int2XY (area), and Delay.

---

- Cannot be used simultaneously with 1 cycle mode (see page 10-44).
- 

### Measurement and Statistical Processing of History Waveforms

Measurement and statistical processing of the selected parameters are performed on the history waveform. Measurement and statistical processing are performed from the oldest data. The range of the history waveform on which measurement and statistical processing are performed is the waveform displayed on the history map (see section 10.1).

### Displaying a List of Measured Values

When measurement per cycle and statistical processing within the measurement range as well as measurement and statistical processing of history waveforms are executed, the measured values of the selected measurement parameters can be listed. Numbers are assigned in order from the left end to the right end of the screen (from the oldest waveform) as #00001, #00002, and so on and the corresponding measured values are displayed.

- The maximum and minimum values of each measurement parameter are displayed using ↑ (maximum) and ↓ (minimum). If there are multiple points that are of the same value, the maximum and minimum values are marked on the oldest of the measured values.
- The maximum number of measured values that can be listed is 24000.
  - If this value is exceeded in the measurement and statistical processing of history waveforms, the most recent 24000 measured values are displayed. If the number of measured values exceed 24000, and the maximum or minimum value resides outside the list display, ↑ (maximum) and ↓ (minimum) are not displayed.
  - In the measurement and statistical processing per cycle, measurement and statistical processing are performed on the 24000 values that can be listed, and measurement and statistical processing are not performed on the rest of the waveform.
- In the list of the measurement and statistical processing of history waveforms, you can select a number using the jog shuttle and press SELECT to display the history waveform of the selected number.
- In the list of the measurement per cycle and statistical processing within the measurement range, you can select a number using the jog shuttle and press SELECT to display the waveform (1 cycle) of the selected number zoomed.

### Note

---

- All soft keys except the "Measure Abort" soft key are disabled while the measurement and statistical processing are in progress.
  - Measurement per cycle and statistical processing within the measurement range are not possible in automated measurement of waveform parameters on dual areas (see section 10.8).
-

# 10.8 Performing Automated Measurements of Waveform Parameters on Dual Areas

<For a description of this function, refer to page 2-29.>

## Procedure

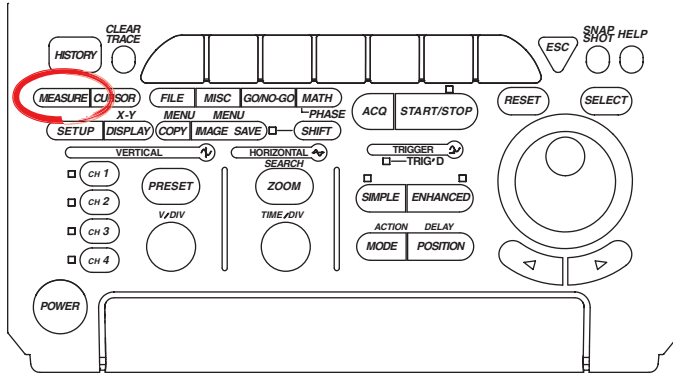

- To exit the menu during operation, press **ESC** located above the soft keys.
- In the procedural explanation below, the term **jog shuttle & SELECT** refers to the operation of selecting/setting items and entering values using the **jog shuttle** and **SELECT** and **RESET** keys. For details on this operation, see sections 4.1 and 4.2.
- For a description of the operation using a USB keyboard or a USB mouse, see section 4.3.

- Press **MEASURE**. The MEASURE menu appears.
- Press the **Mode** soft key. The Mode menu appears.

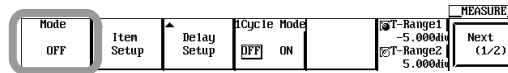

### Entering a Menu for Automatic Measurement of Dual Areas of Waveform Parameters

- Press the **ON, Statistics, or History Statistics** soft key.



- Press the **Item Setup** soft key. The Item Setup menu and Item Setup dialog box appear.

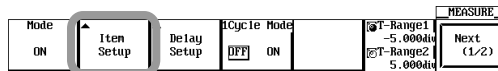

- Press the **Dual Area** soft key to select ON. The Dual Area menu appears.

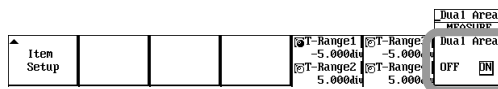

- Press the **Item Setup** soft key. The Item Setup dialog box opens.

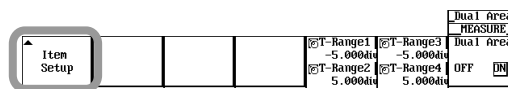

## 10.8 Performing Automated Measurements of Waveform Parameters on Dual Areas

### Setting Computation Parameters

7. Use **jog shuttle & SELECT** to set the following items of computation item User1.
  - Turn the display of the computed items ON or OFF (Mode Box).
  - For the first waveform/constant to be measured, you can select from CH1 to CH4, Math1, Math2, None, or Const1 to Const4 (Trace box for Area1).
  - Select the first measurement parameter (Item box for Area1)
  - Select the operator from +, -, \*, and / (Open box).
  - For the second waveform/constant to be measured, you can select from CH1 to CH4, Math1, Math2, None, or Const1 to Const4 (Trace box for Area2).
  - Select the Second Measurement Parameter (Item Box for Area2)
  - Set the units as necessary (Unit box).
  - \* On the DL1740E/DL1740EL, you can select from CH1 to CH4, Math1, Math2, None or Const1 to Const4. On the DL1720E, you can select from CH1 to CH2, Math1, None or Const1 to Const2.
8. Repeat step 7 to set computation items User2 through User4.
9. Use **jog shuttle & SELECT** to set Const1 to Const4.

The screenshot shows the 'Item Setup' dialog box with the following fields and annotations:

- Mode:** [OFF] [ON] - Annotation: Turn the display of the computed items ON or OFF.
- Area1:**
  - Trace: [CH1] [P-P] - Annotation: For the first waveform/constant to be measured, you can select from CH1 to CH4, Math1, Math2, None, or Const1 to Const4.
  - Item: [P-P] - Annotation: Select the first measurement parameter.
- Area2:**
  - Trace: [CH1] [P-P] - Annotation: For the second waveform/constant to be measured, you can select from CH1 to CH4, Math1, Math2, None, or Const1 to Const4.
  - Item: [P-P] - Annotation: Select the second measurement parameter.
  - Unit: [ ] - Annotation: Set the units as necessary.
- Operator:** [ + ] - Annotation: Select the operator from +, -, \*, and /.

The dialog box contains rows for User1 through User4 and Const1 through Const4. The 'Const' rows have numerical values in the Trace and Item fields.

10. Press **ESC**. The Item Setup dialog box closes.

### Setting the Measurement Range Area1 of the First Measurement Parameter

11. Press the **T-Range1/T-Range2** soft key to set the jog shuttle control to T-Range1, T-Range2, or both T-Range1 and T-Range 2.
  - If you select T-Range1, you can move T-Range1.
  - If you select T-Range2, you can move T-Range2.
  - If you select both T-Range1 and T-Range2, you can move T-Range1 and T-Range2 horizontally without changing the spacing between the two. The value of the digit being specified by T-Range1 changes.

The screenshot shows the 'Dual Area MEASURE' screen. The 'Area1 Area' section is highlighted, showing the following values:

T-Range1	T-Range2	T-Range3	T-Range4
-5.000div	5.000div	-5.000div	5.000div

The 'Dual Area MEASURE' header is also visible.

12. Turn the **jog shuttle** to set the Area1 measurement range.

**Setting the Measurement Range Area2 of the Second Measurement Parameter**

13. Press the **T-Range3/T-Range4** soft key to set the jog shuttle control to T-Range3, T-Range4, or both T-Range3 and T-Range4.
  - If you select T-Range3, you can move T-Range3.
  - If you select T-Range4, you can move T-Range4.
  - If you select both T-Range3 and T-Range4, you can move T-Range3 and T-Range4 horizontally without changing the spacing between the two. The value of the digit being specified by T-Range3 changes.

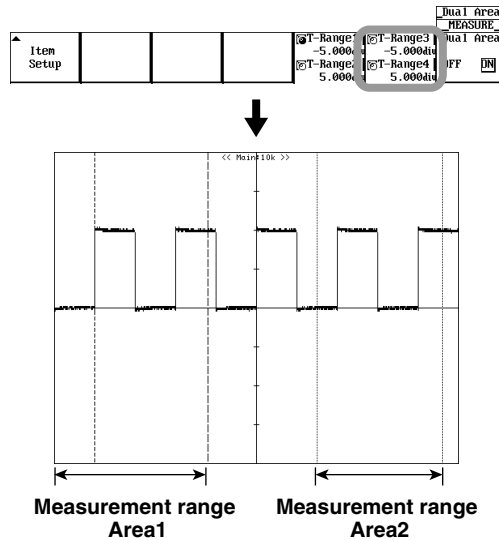

14. Turn the **jog shuttle** to set the Area2 measurement range.

**Setting the Distal, Mesial, and Proximal Values and High and Low Values**

15. The procedure is the same as steps 22 to 32 on page 10-41 to 10-42.

**Explanation**

This section explains the setup procedures for performing automated measurement of various measurement parameters (waveform parameters) on dual areas simultaneously or performing computation using the measured values on the displayed waveform (within the display record length, see appendix 1).

**Limitations**

Automated measurement of waveform parameters cannot be performed on the following waveforms.

- Snapshot waveforms
- Accumulated waveforms (however, measurement is possible on the accumulated waveform acquired last).

**Automated Measurement Mode**

The following modes are available in automated measurement of waveform parameters. To perform automated measurement of waveform parameters on dual areas, select ON, Statistics, or History Statistics mode.

OFF: Automated measurement is not performed.

ON: Measures the specified parameters.

Statistics, Cycle Statistics, and History Statistics:

Performs statistical processing on the measured results of the specified parameters. See section 10.7. However, measurement and statistical processing of Cycle Statistics cannot be performed using automated measurement of waveform parameters on dual areas.

### Measurement Parameters

Twenty-six types of parameters and delay between waveforms can be selected as operands of computation parameters. For details on the measurement parameters, see section 10.6.

### Computation Parameters

- Four parameters, User1 to User4, can be computed and displayed.
- Computation can be performed by setting the measurement parameters of the two areas of the measurement target waveform as operands and using operators +, -, \*, or /. The results are displayed as computation parameters User1 to User4.

- **Equation**

For example, the equation of computation parameter User1 is as follows:

User1 = M1 operator M2

M1: Measurement parameter of Area 1 of the measurement target waveform

M2: Measurement parameter of Area 2 of the measurement target waveform

Operator: +, -, \*, or /

The measurement target waveforms of M1 and M2 can be selected from CH1 to CH4(2)\*, Math1, Math2, None or Const1 to Const4.

\* On the DL1740E/DL1740EL, you can select from CH1 to CH4, Math1, Math2, None or Const1 to Const4. On the DL1720E, you can select from CH1 to CH2, Math1, None or Const1 to Const2.

- If one of the measurement target waveform is set to None, the measured value of the other measurement parameter is displayed.
- If both measurement target waveforms are set to None, the measurement value display area shows ....

### Turning the Computation Parameters ON and OFF

The display of the computation parameters User1 to User4 can be turned ON/OFF separately.

ON: Displays the measurement parameter.

OFF: Does not display the measurement parameter.

### Unit of Computation Parameters

Units can be assigned to computation parameters User1 to User4 using up to four characters.

- The type of characters that can be used are those displayed on the keyboard.
- The specified unit is displayed when the display of the measurement parameter is turned ON.

## 10.8 Performing Automated Measurements of Waveform Parameters on Dual Areas

### Measurement Range

The selectable range is  $\pm 5$  divisions, and the resolution is ten divisions  $\div$  display record length. The right end of the measurement range (T-Range2) must be greater than or equal to the left end of the measurement range (T-Range1), and the right end of the measurement range (T-Range4) must be greater than or equal to the left end of the measurement range (T-Range3).

- Separate measurement ranges (Area1 and Area2) can be specified for measurement parameter 1 and 2.
- The measurement range of dual areas may overlap.

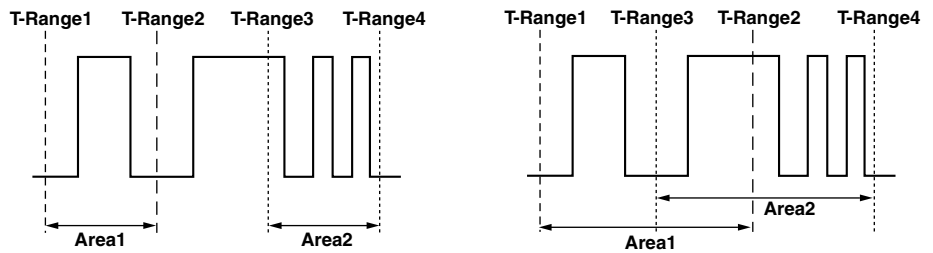

### Setting the Distal, Mesial, and Proximal Values and High and Low Values

The procedure is the same as with the normal automated measurement of waveform parameters on a single area. See section 10.6.

### Note

- If measurement is not possible, \*\*\* is displayed in the measured value display area.
- If the measurement mode is Degree and the reference point is Trig, \*\*\* is displayed in the measured value display area.
- For waveforms of small amplitude, correct measurements may not be possible.
- If there are two or more periods of waveform in the measurement range, the measurement is performed on the first period.



# 10.9 Performing GO/NO-GO Determination Using Zones

<For a description of this function, refer to page 2-29.>

## Procedure

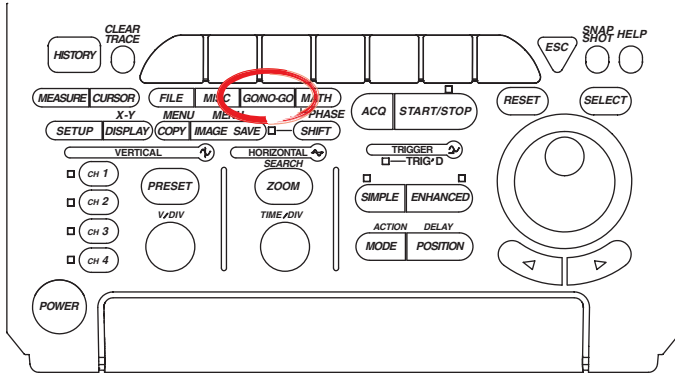

- To exit the menu during operation, press **ESC** located above the soft keys.
- In the procedural explanation below, the term **jog shuttle & SELECT** refers to the operation of selecting/setting items and entering values using the **jog shuttle** and **SELECT** and **RESET** keys. For details on this operation, see sections 4.1 and 4.2.
- For a description of the operation using a USB keyboard or a USB mouse, see section 4.3.

1. Press **GO/NOGO**. The GO/NO-GO menu appears.
2. Press the **Mode** soft key. The Mode menu appears.

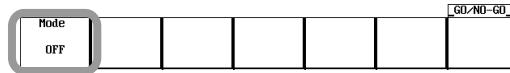

### Entering the GO/NO-GO Determination Setup Menu

3. Press the **Zone** soft key. The Zone menu appears.

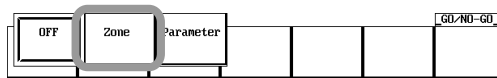

### Creating Determination Zones

Stop waveform acquisition after displaying the reference waveform, and then create the zone.

4. Press the **To EditMenu** soft key. The To Edit menu appears.

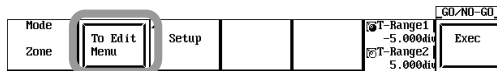

### Creating a New Zone

5. Press the **New** soft key. The Trace menu appears.



6. Press the **CH1 to CH4(2)**, **Math1**, or **Math2** soft key to select the waveform to be the reference for creating the zone. The Edit menu appears.

- On the DL1740E/DL1740EL, select CH1 to CH4, Math1, or Math2.
- On the DL1720E, you can select the CH1-CH2 or Math1 soft key.

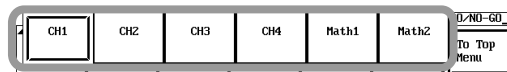

• **Editing the Entire Zone**

7. Press the **Edit** soft key to select Whole.

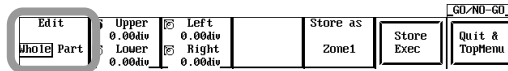

8. Press the **Upper/Lower** or **Left/Right** soft key to set the jog shuttle control to Upper, Lower, Left, or Right.

- If you select Upper, you can edit the zone upward with respect to the reference waveform.
- If you select Lower, you can edit the zone downward with respect to the reference waveform.
- If you select Left, you can edit the zone toward the left with respect to the reference waveform.
- If you select Right, you can edit the zone toward the right with respect to the reference waveform.



9. Turn the **jog shuttle** to edit the entire zone.

• **Editing Parts of Zones**

10. Press the **Edit** soft key to select Part.

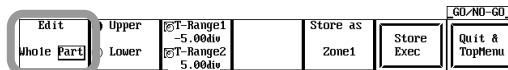

11. Press the **T-Range1/T-Range2** soft key to set the jog shuttle control to T-Range1 or T-Range2.

- If you select T-Range1, you can move T-Range1.
- If you select T-Range2, you can move T-Range2.

12. Turn the **jog shuttle** to set the range of the partial zone to be edited.

13. Press the **Upper/Lower** soft key to set the jog shuttle control to Upper or Lower.

- If you select Upper, you can edit the zone upward with respect to the reference waveform in the range between T-Range1 and T-Range2.
- If you select Lower, you can edit the zone downward with respect to the reference waveform in the range between T-Range1 and T-Range2.



14. Turn the **jog shuttle** to edit part of the zone.

• **Registering the Edited Zone**

15. Press the **Store as** soft key. The Store as menu appears.



16. Press one of the soft keys from **Zone1** to **Zone6** to select the registration destination.

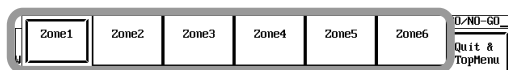

17. Press the **Store Exec** soft key. The edited zone is registered to the selected destination.

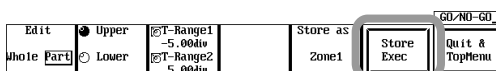

## 10.9 Performing GO/NO-GO Determination Using Zones

### • Exiting the Zone Editing

18. Press the **Quit & To TopMenu** soft key. The screen returns to the menu shown in step 3.

If you press the Quit & To TopMenu soft key without registering the edited zone in steps 15 to 17, the editing up to that point is discarded, and the screen returns to the menu of step 3.

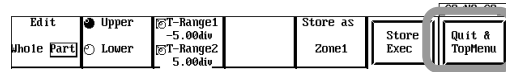

### • Modifying the Registered Zone

Turn on the display of the reference waveform that was selected when the zone was created, and then correct the zone.

19. At step 5, press the **Redraw** soft key. A menu for selecting the registered zone appears.

20. Repeat steps 7 and 18 to modify the registered zone.

The corrected zone can be registered to a different destination.

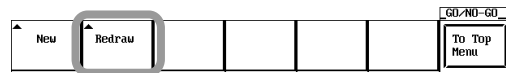

### Setting the Determination Conditions

21. At step 4, press the **Setup** soft key. The Setup dialog box opens.



22. Use **jog shuttle & SELECT** to set the following items of determination zone Zone1.
- Select the determination target waveform from CH1 to CH4 (2), Math1, or Math2 (Trace box).
  - Select whether to perform determination at the corresponding determination zone (ON/OFF) (Mode box).
  - Select whether the waveform exiting the determination zone (OUT) or entering the determination zone (IN) (Condition box).
- \* On the DL1740E/DL1740EL, you can select from CH1 to CH4, Math1, and Math2. On the DL1720E, you can select CH1, CH2, and Math1.
23. Repeat step 22 to set determination zones Zone2 to Zone6.
24. Use **jog shuttle & SELECT** to set the determination logic to AND or OR (Logic box).
25. Use **jog shuttle & SELECT** to set the determination operation to Single or Continue (Sequence box).
26. Use **jog shuttle & SELECT** to set the waveform acquisition count (ACQ Count box).
27. Use **jog shuttle & SELECT** set the instrument action when the condition is met (Action box).

Select the determination target waveform from CH1 to CH4 (2), Math1, or Math2.

Select whether to perform determination at the corresponding determination zone (ON/OFF).

Select which condition when the waveform exits the determination zone (OUT) or when the waveform enters the determination zone (IN) is considered true.

Determination zone Zone1  
Determination zone Zone2  
Determination zone Zone3  
Determination zone Zone4  
Determination zone Zone5  
Determination zone Zone6

	Trace	Mode	Condition
Zone1	CH1	OFF	OUT
Zone2	CH2	OFF	IN
Zone3	CH3	OFF	IN
Zone4	CH4	OFF	IN
Zone5	Math1	OFF	IN
Zone6	Math2	OFF	IN
Logic	AND OR		
Sequence	Single Continue		
ACQ Count	Infinite		
Action	<input type="checkbox"/> Buzzer <input type="checkbox"/> Save to File <input type="checkbox"/> Hard Copy <input type="checkbox"/> Image Save <input type="checkbox"/> Send Mail   Mail Count: 100		

Set the determination logic to AND or OR.

Set the determination operation to Single or Continue.

Set the number of waveform acquisitions.

Set the action taken by the instrument when the condition is met.

28. Press **ESC**. The Setup dialog box closes.

**Setting the Determination Range**

29. Press the **T-Range1/T-Range2** soft key to set the jog shuttle control to T-Range1, T-Range2, or both T-Range1 and T-Range 2.
- If you select T-Range1, you can move T-Range1.
  - If you select T-Range2, you can move T-Range2.
  - If you select both T-Range1 and T-Range2, you can move T-Range1 and T-Range2 horizontally without changing the spacing between the two. The value of the digit being specified by T-Range1 changes.

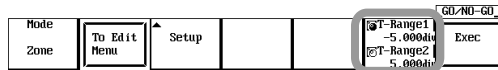

**Executing/Aborting the Determination**

30. Press the **Exec** soft key. GO/NO-GO determination is executed. The Exec soft key changes to the Abort soft key.
- To abort GO/NO-GO determination, press the **Abort** soft key or press **START/STOP**. GO/NO-GO determination is aborted, and the word Abort changes to Exec.

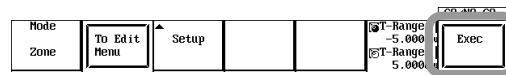

**Determination count**

Exec Count: 10  
Result: 000X--

NG Count: 10

Number of times the condition is met  
When all the conditions including the determination logic are met, it is counted as NG (NO-GO).

The image shows the control panel displaying the determination count results. The 'Exec Count' is 10 and the 'Result' is 000X--. The 'NG Count' is 10. The 'GO/NO-GO' button is highlighted with a red box.

Displays the determination results of each determination zone in the order Zone1 to Zone6 (Displays the determination results of determination zones whose Mode is ON)

**Zone1 determination results**

Zone2  
Zone3  
000X--  
Zone6  
Zone5  
Zone4

When the conditions of the determination zone are not met: O  
When the conditions of the determination zone are met: X  
When the mode is not turned ON: -

### Explanation

This section explains the setup procedures for creating determination zones based on a reference waveform and performing GO/NO-GO determination on whether the waveform exits or enters the determination zones.

#### Determination Target Waveform

The waveform on which GO/NO-GO determination is performed is CH1 to CH4(2)\*, Math1, or Math2.

- \* On the DL1740E/DL1740EL, the waveform is CH1 to CH4, Math1, or Math2. On the DL1720E, you can select CH1, CH2, and Math1.

#### Determination Zones

- The reference waveform for creating the zone is selected from the displayed waveforms, and six determination zones, Zone1 to Zone6, are created and registered. The selectable range of the zone is as follows:  
Selectable range in the up and down direction:  
8 divisions above and below the reference waveform.  
Selectable range in the left and right direction:  
5 divisions to the left and right from the screen center.
- You can select the reference waveform for creating determination zones from CH1 to CH4(2)\*, Math1, and Math2.
  - \* On the DL1740E/DL1740EL, you can select from CH1 to CH4, Math1, and Math2. On the DL1720E, you can select CH1, CH2, and Math1.
- The zone can be edited entirely or partially with respect to the reference waveform.
- Registered zones can be modified.

#### Determination Condition and Instrument Action When the Condition Is Met

For each determination zone, you can select the following items.

- Determination target waveform (see “Determination Target Waveform” described above.)
- Enable or disable determination (ON/OFF).
- Select which condition when the waveform exits the determination zone (OUT) or when the waveform enters the determination zone (IN) is considered true.

#### Determination Logic

You can select the AND logic or OR logic of the determination conditions of the six determination zones in performing the search.

AND: Condition is considered to be true when all the determination conditions of Zone1 to Zone6 are met.

OR: Condition is considered to be true when any of the determination conditions of Zone1 to Zone6 is met.

#### Determination Operation: Sequence

You can select whether to repeat the determination operation.

Single: Performs the determination operation once.

Continue: Repeats the determination operation until the waveform acquisition count (described below) is reached. If the waveform acquisition count is set to Infinite, determination operation repeats until it is aborted.

#### Waveform Acquisition Count: ACQ Count

You can set the number of waveform acquisitions.

Infinite: Continues until waveform acquisition is aborted using the START/STOP key or Abort soft key.

1-65536: Waveform acquisition and determination operation stop when the specified number of waveforms are acquired.

**Instrument Action When the Condition Is Met**

You can select the action that instrument takes when the condition is met. When the condition is met, it is counted as a failure.

Buzzer: Sounds a buzzer.

Save to File: Saves data to the storage medium (floppy disk, PC card, Net Drive\*, or USB storage) specified in the FILE menu.

Hard Copy: Outputs the screen image data to the destination (built-in, USB, or Net Print1\*) specified by "Copy to" in the COPY menu.

Image Save: Saves screen image data to the storage medium (floppy disk, PC card, Net Drive\*, or USB storage) specified in the IMAGE menu.

Send Mail: Sends a mail message. Set the mail send count in the range from 1 to 1000. For details, see section 13.5.

\* When the Ethernet interface option is installed

- **Save to File/Hard Copy/Image Save Operation**

The operation follows the settings specified on the FILE, PRINT, or Image Save menu.

- **File Name When Save to File or Image Save Is Specified**

The file is saved using Auto Name under the File menu or the Image Save menu. For details, see section 12.5 or 12.9.

**Determination Range: T-Range1/T-Range2**

The selectable range is  $\pm 5$  divisions, and the resolution is ten divisions  $\div$  display record length. The right end of the determination range (T-Range2) must be greater than or equal to the left end of the determination range (T-Range1).

**Executing/Aborting GO/NO-GO Determination**

- When executed, the determination count (Exe Count), the number of times the condition is met (NG Count), and the determination result of each determination zone are displayed on the screen.
- All keys other than the START/STOP key and the Abort soft key are disabled while determination is in progress.

**Note**

- When GO/NO-GO determination is executed, the trigger mode is automatically set to "Single."
- Determination is not possible when the acquisition mode is set to Average.
- The determination zones that you create are stored as setup data to the storage medium or built-in memory.

# 10.10 Performing GO/NO-GO Determination Using Automated Measurement of Waveform Parameters

<For a description of this function, refer to page 2-29.>

## Procedure

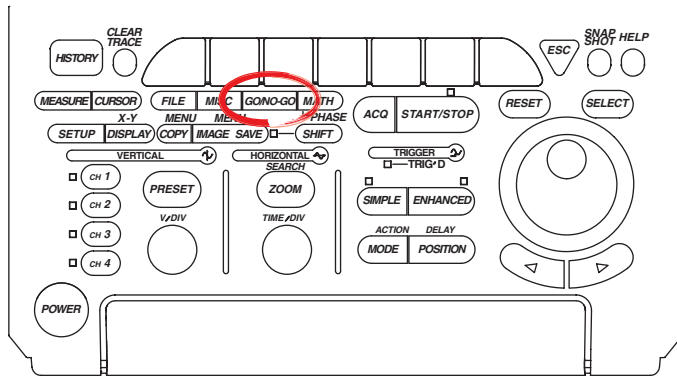

- To exit the menu during operation, press **ESC** located above the soft keys.
- In the procedural explanation below, the term **jog shuttle & SELECT** refers to the operation of selecting/setting items and entering values using the **jog shuttle** and **SELECT** and **RESET** keys. For details on this operation, see sections 4.1 and 4.2.
- For a description of the operation using a USB keyboard or a USB mouse, see section 4.3.

- Press **GO/NO-GO**. The GO/NO-GO menu appears.
- Press the **Mode** soft key. The Mode menu appears.



### Entering the GO/NO-GO Determination Setup Menu

- Press the **Parameter** soft key. The Parameter menu appears.

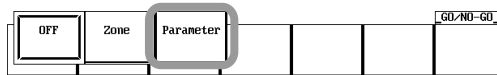

### Setting the Determination Conditions

- Press the **Setup** soft key. The Setup dialog box opens.



- Use **jog shuttle & SELECT** to set the following items of determination parameter Param1.
  - Select whether to perform determination at the corresponding determination parameter (ON/OFF) (Mode box).
  - Select the determination target waveform from CH1 to CH4 (2), Math1, or Math2 (Trace box).
  - Select the measurement parameter (Item box).
  - Set the upper and lower limits used to determine the measured value (Upper and Lower box).
  - Select whether the measured value exiting the range defined by the upper and lower limits (OUT) or entering the range (IN) (Condition box) makes the condition true.
    - \* On the DL1740E/DL1740EL, you can select from CH1 to CH4, Math1, and Math2. On the DL1720E, you can select CH1, CH2, and Math1.
- Repeat step 5 to set determination parameters Param2 to Param4.
- Use **jog shuttle & SELECT** to set the determination logic to AND or OR (Logic box).
- Use **jog shuttle & SELECT** to set the determination operation to Single or Continue (Sequence box).

## 10.10 Performing GO/NO-GO Determination Using Automated Measurement of Waveform Parameters

9. Use **jog shuttle & SELECT** to set the waveform acquisition count (ACQ Count box).
10. Use **jog shuttle & SELECT** to set the instrument action when the condition is met (Action box).

The screenshot shows the 'Setup' dialog box for GO/NO-GO determination. It contains the following fields and callouts:

- Determination parameter Param1** to **Param4**: Labels for the four parameter columns.
- Mode**: OFF, DN, OFF, DN, OFF, DN, OFF, DN. Callout: "Select whether to perform determination using the corresponding determination parameter (ON/OFF)."
 

Param1	Param2	Param3	Param4
OFF	DN	OFF	DN
OFF	DN	OFF	DN
OFF	DN	OFF	DN
OFF	DN	OFF	DN
- Trace**: CH1, CH1, CH2, CH2. Callout: "Select the determination target waveform from CH1 to CH4 (2), Math1, or Math2."
 

Param1	Param2	Param3	Param4
CH1	CH1	CH2	CH2
- Item**: Max, Min, Rms, Avg. Callout: "Select the measurement parameter."
 

Param1	Param2	Param3	Param4
Max	Min	Rms	Avg
- Upper**: 2.0000E+00, 0.0000E+00, XXX, XXX. Callout: "Set the upper and lower limits used to determine the true/false condition of the measure values."
 

Param1	Param2	Param3	Param4
2.0000E+00	0.0000E+00	XXX	XXX
- Lower**: -1.0000E+00, -6.0000E+00, XXX, XXX. Callout: "Select which condition when the measured value exits the range defined by the upper and lower limits (OUT) or when the waveform enters the range (IN) is considered true."
 

Param1	Param2	Param3	Param4
-1.0000E+00	-6.0000E+00	XXX	XXX
- Condition**: OUT, IN, OUT, IN, OUT, IN, OUT, IN. Callout: "Set the determination logic to AND or OR."
 

Param1	Param2	Param3	Param4
OUT	IN	OUT	IN
OUT	IN	OUT	IN
OUT	IN	OUT	IN
OUT	IN	OUT	IN
- Logic**: AND, OR. Callout: "Set the determination operation to Single or Continue."
 

Param1	Param2	Param3	Param4
AND	OR		
- Sequence**: Single, Continue. Callout: "Set the number of waveform acquisitions."
 

Param1	Param2	Param3	Param4
Single	Continue		
- ACQ Count**: 10. Callout: "Set the action taken by the instrument when the condition is met."
 

Param1	Param2	Param3	Param4
10			
- Action**: Buzzer, Save to File, Hard Copy, Image Save, Send Mail, Mail Count, 100. Callout: "Set the action taken by the instrument when the condition is met."
 

Param1	Param2	Param3	Param4
Buzzer	Save to File	Hard Copy	
Image Save	Send Mail	Mail Count	100

11. Press **ESC**. The Setup dialog box closes.

### Setting the Determination Range

12. Press the **T-Range1/T-Range2** soft key to set the jog shuttle control to T-Range1, T-Range2, or both T-Range1 and T-Range 2.
  - If you select T-Range1, you can move T-Range1.
  - If you select T-Range2, you can move T-Range2.
  - If you select both T-Range1 and T-Range2, you can move T-Range1 and T-Range2 horizontally without changing the spacing between the two. The value of the digit being specified by T-Range1 changes.

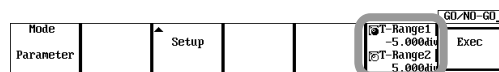



## 10.10 Performing GO/NO-GO Determination Using Automated Measurement of Waveform Parameters

### Executing/Aborting the Determination

13. Press the Exec soft key. GO/NO-GO determination is executed. The Exec soft key changes to the Abort soft key.

To abort GO/NO-GO determination, press the Abort soft key or press START/STOP. GO/NO-GO determination is aborted, and the word Abort changes to Exec.

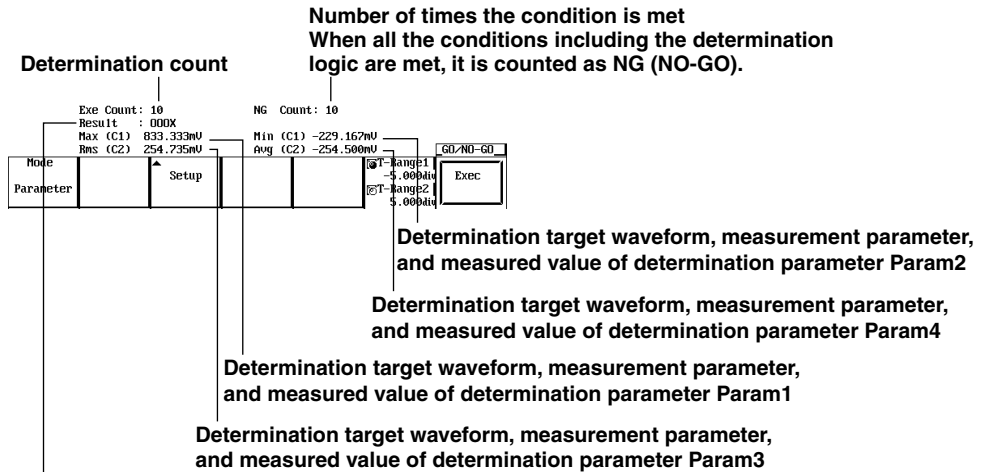
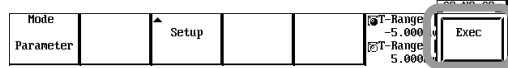

Displays the determination results of each determination parameter in the order Param1 to Param4

(Displays the determination results of determination parameters whose Mode is ON)

#### Param1 determination results

Param2	When the conditions of the determination parameter are not met: O
OOOX	When the conditions of the determination parameter are met: X
Param4	When the mode is not turned ON: -
Param3	

**Explanation**

This section explains the setup procedures for performing GO/NO-GO determination based on whether the measured value of the waveform parameter (measurement parameter) exits or enters the range specified by the upper and lower limits.

**Determination Target Waveform**

The waveform on which GO/NO-GO parameter determination is performed is CH1 to CH4(2)\*, Math1, or Math2.

- \* On the DL1740E/DL1740EL, the waveform is CH1 to CH4, Math1, or Math2. On the DL1720E, you can select CH1, CH2, and Math1.

**Determination Parameter**

- Up to four determination parameters, Param1 to Param4 can be specified. You can select the determination parameter from the measurement parameters of automated measurement of waveform parameters (including delay between channels).
- You can set the upper and lower limits used to determine the true/false condition of the measured value of the determination parameter in the range of  $-9.9999E+30$  to  $9.9999E+30$ .

**Determination Condition and instrument Action When the Condition Is Met**

For each determination parameter, you can select the following items.

- Determination target waveform (see “Determination Target Waveform” described above.)
- Enable or disable determination (ON/OFF).
- Select whether the measured value exiting the range defined by the upper and lower limits of the determination parameters (OUT) or entering the range (IN) (Condition box) makes the condition true.

**Determination Logic**

You can select the AND logic or OR logic of the determination conditions of the four determination parameters in performing the search.

AND: Condition is considered to be true when all the determination conditions of Param1 to Param4 are met.

OR: Condition is considered to be true when any of the determination conditions of Param1 to Param4 is met.

**Determination Operation, Waveform Acquisition Count, Instrument Action When the Condition Is Met, and Determination Range**

They are the same as the GO/NO-GO determination using zones. See section 10.9.

**Executing/Aborting GO/NO-GO Determination**

- When executed, the determination count, the number of times the condition is met, and the determination result, determination target waveform, measurement parameter, and measured value of each determination parameter are displayed on the screen.
- All keys other than the START/STOP key and the Abort soft key are disabled while determination is in progress.

**Note**

- When GO/NO-GO determination is executed, the trigger mode is automatically set to “Single.”
- Determination is not possible when the acquisition mode is set to Average.

# 10.11 Using the GO/NO-GO Determination Signal Output Function

## Output Signal

### NO-GO OUT Signal

When the determination result is NO-GO, the output signal level (TTL level) temporarily changes from high (H) to low (L).

### GO OUT Signal

When the determination result is GO, the output signal level (TTL level) temporarily changes from low (L) to high (H).

### Circuit Diagram of the Signal Output Section

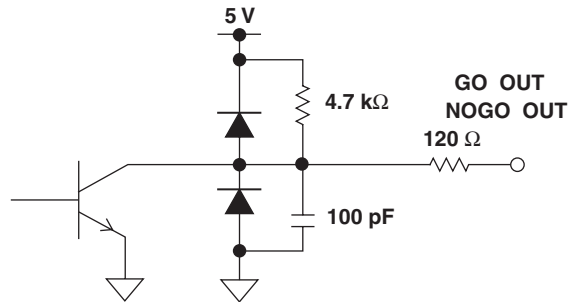

## Signal Output Connector

The configuration and pin assignments of the signal output connector are as follows.

### Configuration

The connector uses an RJ-12 modular jack. It is recommended to use the accessory GO/NO-GO cable (part no. 366973), sold separately. If another commercially available cable is used (a modular 4-wire telephone cable), make sure the cable is wired as follows.

### Pin Assignments

GO/NO-GO	Pin no.	Signal	Logic
	1	NC (not connected)	
	2	NC (not connected)	
	3	GO OUT	Negative
	4	NO-GO OUT	Negative
	5	GND	
	6	NC (not connected)	

Connector on the unit side

### Output Timing

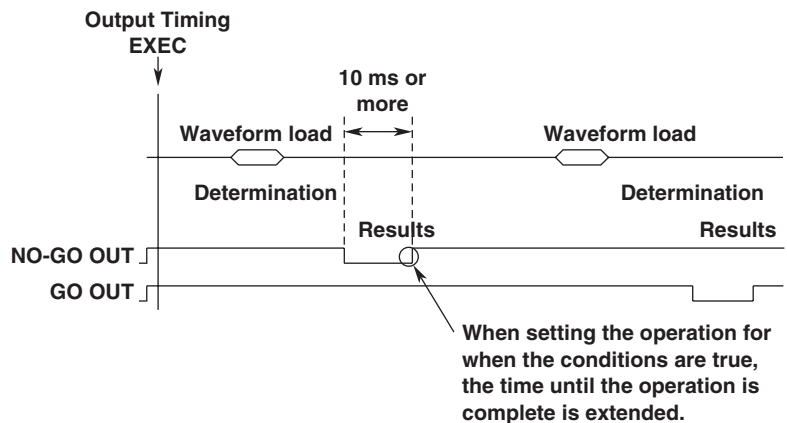

Connections to Other Devices

**CAUTION**

- Do not apply external voltage to the NO-GO OUT or GO OUT output pins. Doing so can cause damage to the instrument.
- When connecting the GO/NO GO determination signal output externally, do not mistakenly connect a different signal pin. Doing so may damage the DL1720E/DL1740E/DL1740EL or the device connected to it.
- Do not accidentally insert a USB cable into the GO/NO-GO output terminal. Doing so can cause damage to the instrument.

It is recommended to use the accessory GO/NO-GO cable (part no. 366973, sold separately) for connections with external devices.

Do not use the GO/NO-GO cable (part no. 366973) for any purpose other than GO/NO-GO determination on this instrument.

**Specifications of the GO/NO-GO Cable (part no. 366973)**

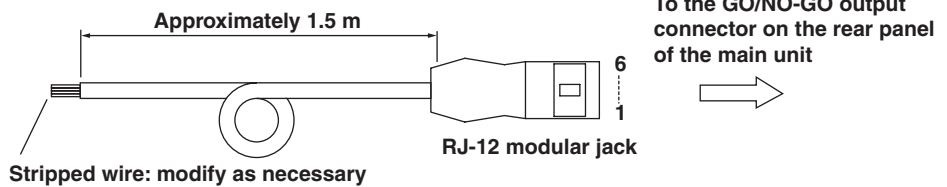

Color	Pin No.	Signal	Logic
Yellow	2	NC	
White	3	GO OUT	Negative
Green	4	NO-GO OUT	Negative
Blue	5	GND	

## 11.1 Installing the Roll Paper into the Built-in Printer (Optional)

### Roll Paper for Printer

The instrument uses a dedicated roll paper provided by YOKOGAWA. Do not use other types of roll paper. When you are using the printer for the first time, use the roll paper that came with the package. When the roll paper runs out, contact your YOKOGAWA dealer.

Part No.: B9850NX  
Specifications: Thermalsensible paper, 30 m  
Lot Qty.: 5 rolls

### Handling the Roll Paper

The paper is a thermalsensible paper that changes color with the application of heat. Take note of the following points.

#### Storage Precautions

The printer's thermalsensible paper gradually begins to yellow at approximately seventy degrees Celsius. It is affected by heat, humidity, light, and chemicals regardless of whether the paper has been used.

- Store the paper rolls in a cool, dry, and dark place.
- After opening the package, use it quickly.
- If the paper is left in contact with plastic film (such as a vinyl chloride film or Scotch tape) containing plasticizers for an extended time, the paper will lose some of its ability to reproduce color. If you are going to store the paper in a folder, for example, use a folder made of polypropylene or wood fiber.
- When using glue on the paper, do not use glue containing organic solvents such as alcohol or ether, as they will change the color of the paper.
- For prolonged storage, we suggest you make copies of the results printed on the roll paper. Due to the characteristics of the thermalsensible paper, it may lose color over time.

#### Handling Precautions

- Be sure to use only genuine paper rolls provided by YOKOGAWA.
- Touching the paper with sweaty hands can leave finger print marks or blur the printing.
- Rubbing the surface with a hard object can cause the paper to change color due to the heat caused by friction.
- If chemicals, oil, or other liquids come in contact with the paper, the paper may change color or the printing may fade.

## 11.1 Displaying and Labeling Computed Waveforms

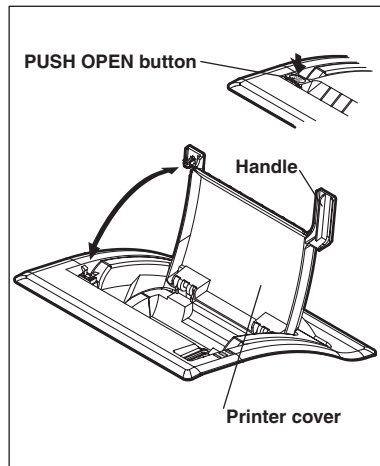

To open the printer cover, push the PUSH-OPEN button and lift the handle on the right side of the printer cover.

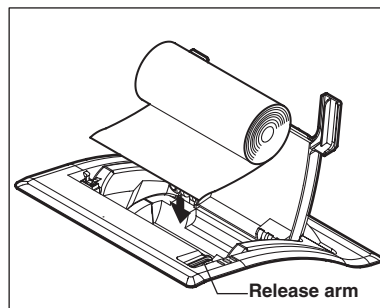

Move the release arm located on the right near the front to the MAN FEED position. Hold the roll paper so that the inner side of the roll paper (the side that is not glossy) is facing up, then place the roll in the holder.

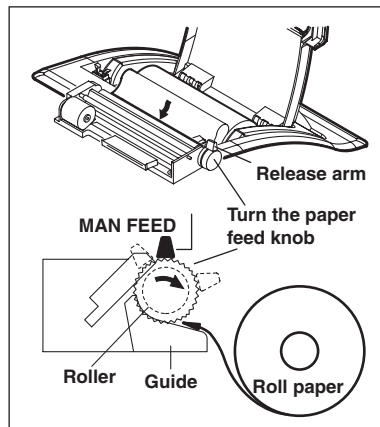

Insert the edge of the roll paper evenly in the space between the roller and the black guide, then rotate the paper feed knob towards you until about 10 cm of the paper extends beyond the top of the roller.

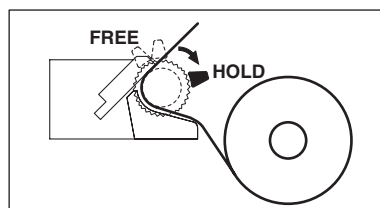

Move the release arm to the FREE position and straighten out the paper. Then, move the release arm to the HOLD position.

The printing will fail with an error message if the release arm is in the FREE or MAN FEED position during operation.

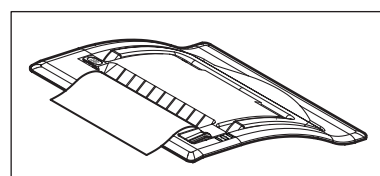

Pull the printer cover back to its original position and close the cover. Make sure that the edge of the roll paper feeds through the opening of the printer cover.

Push the printer cover down firmly until it clicks into place.

### Note

The paper feeding may not be stable immediately after the roll paper is installed. Print two or three pages of test images in advance.

## 11.2 Printing Using the Built-in Printer (Optional)

### Procedure

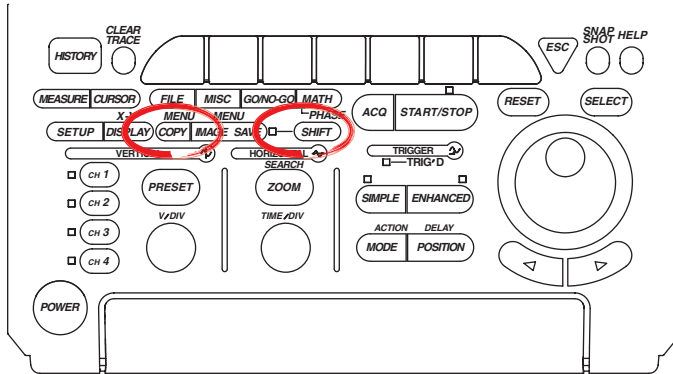

- To exit the menu during operation, press **ESC** located above the soft keys.
- In the procedural explanation below, the term **jog shuttle & SELECT** refers to the operation of selecting/setting items and entering values using the **jog shuttle** and **SELECT** and **RESET** keys. For details on this operation, see sections 4.1 and 4.2.
- For a description of the operation using a USB keyboard or a USB mouse, see section 4.3.

1. Press **SHIFT+COPY(MENU)**. The COPY menu appears.

#### Selecting the Built-in Printer

2. Press the **Copy to** soft key. The Copy to menu appears.

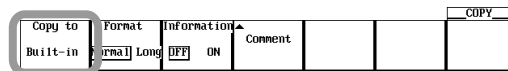

3. Press the **Built-in** soft key.  
Net Print appears only if the Ethernet interface option is installed.

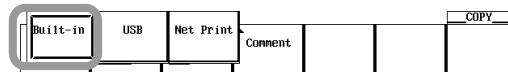

#### Setting the Print Format

4. Press the **Format** soft key to select Normal or Long.
  - If you select Normal, proceed to step 12.
  - If you select Long, proceed to step 5.

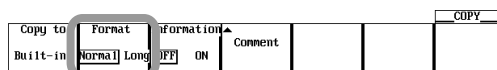

#### Entering Zoom Rate Settings

5. Press the **Mag** soft key. The number of pages that will be printed at the specified Mag value (magnification) is displayed.

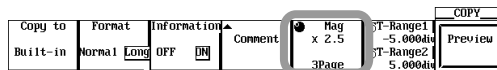

6. Turn the **jog shuttle** to set the zoom rate.

## 11.2 Printing Using the Built-in Printer (Optional)

### Setting the Print Range

7. Press the **T-Range1/T-Range2** soft key to set the jog shuttle control to T-Range1, T-Range2, or both T-Range1 and T-Range 2.
  - If you select T-Range1, you can move T-Range1.
  - If you select T-Range2, you can move T-Range2.
  - If you select both T-Range1 and T-Range2, you can move T-Range1 and T-Range2 horizontally without changing the spacing between the two. The value of the digit being specified by T-Range1 changes.

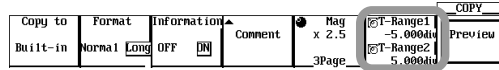

8. Turn the **jog shuttle** to set the print range.

### Previewing the Print Image

9. Press the **Preview** soft key. The Preview menu and the print image per page are displayed. The word Preview changes to Quit.

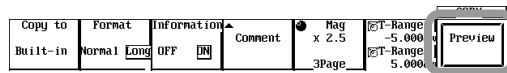

10. Turn the **jog shuttle** to select the page within the range of the total number of pages that vary depending on the magnification specified in step 5. The print image of the selected page is displayed.
11. To exit from the print image preview, press the **Quit** soft key. You can also exit from the print image preview by pressing other soft keys and panel keys excluding a portion of the keys.

### Turning the Additional Information and Comments ON and OFF

12. Press the **Information** soft key to select ON or OFF.



13. Press the **Comment** soft key. A keyboard used to enter values and strings appears.
14. Use **jog shuttle & SELECT** to set the comment.

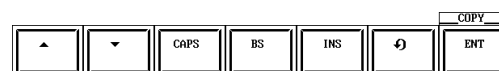
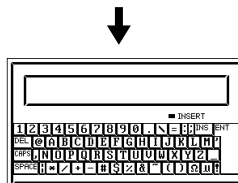

### Printing

15. Press **COPY**. The screen image is printed on the built-in printer. To abort printing, press COPY while printing is in progress. While printing is in progress,  is indicated at the upper left corner of the screen.



**Explanation****Print Format**

In addition to normal printing (one page per screen), "long printing" that allows the waveforms of the specified print range to be printed by expanding the time axis is available. The magnification varies depending on the T/div setting and the record length.

**Magnification**

The range is from 2 to 500000 times. The selectable range varies depending on the T/div setting and the record length.

**Print Range**

The selectable range is  $\pm 5$  divisions, and the resolution is ten divisions  $\div$  display record length.

**Additional Information**

Setup data can be printed simultaneously with the waveform.

**Comment**

A comment text of up to twenty characters can be printed at the bottom of the print page. The entered comment is displayed at the lower right section of the screen.

**Previewing the Print Image**

You can preview the print image of the specified print format on the screen.

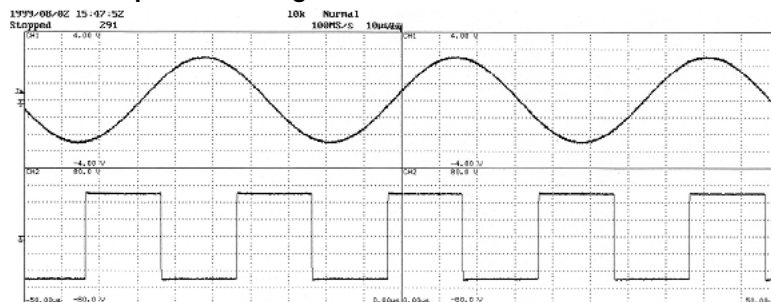
**Print Example of the Long Print Format****Note**

- Long Copy is not possible while waveform acquisition is in progress.
- Only Main waveforms are applicable for long copy.
- If history waveforms are displayed, only the waveform selected by Select Record are applicable for long copy.
- Long copy is not possible on snapshot and accumulated waveforms.

# 11.3 Printing Using a USB Printer

## Procedure

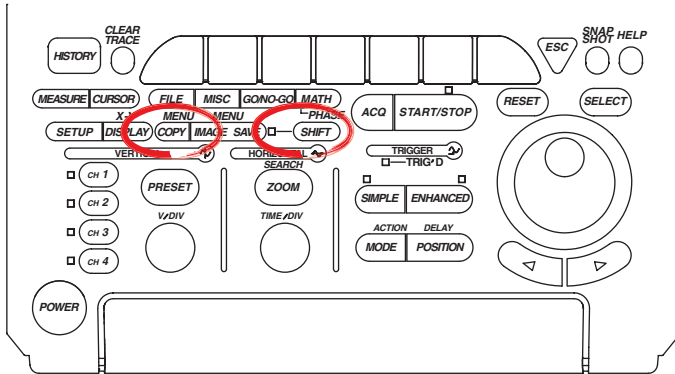

- To exit the menu during operation, press **ESC** located above the soft keys.
- In the procedural explanation below, the term **jog shuttle & SELECT** refers to the operation of selecting/setting items and entering values using the **jog shuttle** and **SELECT** and **RESET** keys. For details on this operation, see sections 4.1 and 4.2.
- For a description of the operation using a USB keyboard or a USB mouse, see section 4.3.

1. Connect the instrument and a USB printer using a USB cable. For details, see the explanation in this section (page 11-8).

### Selecting the USB Printer

1. Press **SHIFT+COPY(MENU)**. The COPY menu appears.
3. Press the **Copy to** soft key. The Copy to menu appears.

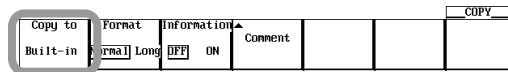

4. Press the **USB** soft key.  
Built-in and Net Print appear if the built-in printer option and the Ethernet interface option are installed, respectively.

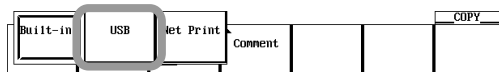

### Checking the Connected Printer

5. Press the **Select** soft key. The USB Device List window appears. Check the printer that is connected.

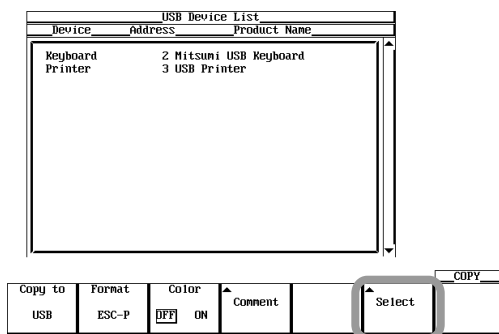

5. Press the **ESC** soft key. The USB Device List window closes.

### Note

You can also check the printer that is connected from the MISC key > Next (1/2) > USB > Device List menu.

**Selecting the Page Description Language or Printer Type**

6. Press the **Format** soft key. The Format menu appears.



7. Press **ESC-P**, **ESC-P2**, **LIPS3**, **PCL5**, or **BJ** to select the page description language or printer type.

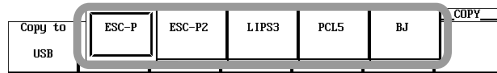

**Turning Color Printing ON and OFF**

(Selectable if the page description language or printer type is set to ESC-P, ESCP2, PCL5, or BJ in step 7)

8. Press the **Color** soft key to select ON or OFF.



**Entering Comments**

9. Press the **Comment** soft key. A keyboard used to enter values and strings appears.

10. Use **jog shuttle & SELECT** to set the comment.

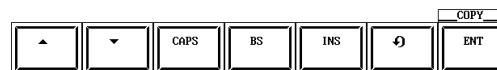
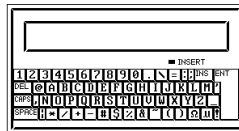

**Selecting the Output Resolution**

(Selectable only if the page description language or printer type is set to BJ in step 7)

11. Press the **Resolution** soft key. The Resolution menu appears.

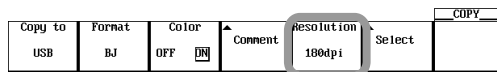

12. Press the **180dpi**, **300dpi**, **360dpi**, or **600dpi** soft key to set the output resolution.



**Printing**

13. Press **COPY**. The screen image is printed on the USB printer.

To abort printing, press **COPY** while printing is in progress.

While printing is in progress,  is indicated at the upper left corner of the screen.

### Explanation

You can print the screen image to a USB printer via the USB PERIPHERAL interface.

### Connecting the Instrument and the USB Printer

#### USB PERIPHERAL Connector

To connect a USB printer to the instrument, connect a USB cable to the USB PERIPHERAL connector. There are two USB PERIPHERAL connectors (ports).

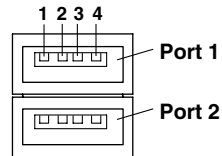

Pin No.	Signal Name
1	VBUS: +5 V
2	D- +Data
3	D+ -Data
4	GND: Ground

#### Printers That Can Be Used

USB printers conforming to USB Printer Class Version 1.0 that support the following print formats can be used.

#### Note

- Connect only the printers that are allowed.
- For details on USB printers that have been tested for compatibility, contact your nearest YOKOGAWA dealer.

#### Connection Procedure

When connecting a USB printer, directly connect the printer to the instrument using a USB cable as shown below. You can connect the USB cable regardless of the power ON/OFF state of the instrument (supports hot-plugging). Connect the type A connector of the USB cable to the instrument; connect the type B connector to the printer. When the power switch is ON, the printer is detected and enabled approximately six seconds after it is connected.

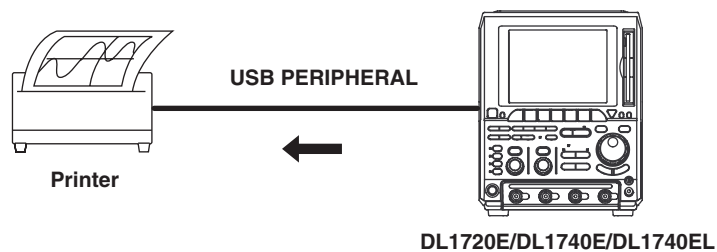

#### Note

- Connect the printer directly without going through a hub.
- Do not connect USB devices other than USB keyboard, USB mouse, USB printer, and USB storage that can be used to the USB PERIPHERAL connector.
- Do not connect multiple printers to the USB PERIPHERAL connector.
- Do not turn OFF the printer or remove the USB cable while the printer is printing.
- Do not connect or disconnect the USB cable after the power is turned ON until key operation is ready (approximately 20 to 30 s).

**Page Description Language or Printer Type: Format**

You can select a page description language and printer type from ESC-P, ESC-P2, LIPS3, PCL5, or BJ (can be used on models that support the BJC-35 V native commands).

**Output Resolution**

(Only when the page description language or printer type is set to BJ)

You can select the print resolution of screen images to match the resolution of the USB-compatible BJ printer.

180dpi, 300dpi, 360dpi, 600dpi

**Comment**

A comment text of up to twenty characters can be printed at the bottom of the print page. The entered comment is displayed at the lower right section of the screen.

**Turning Color Printing ON and OFF**

You can select whether to print in color if the page description language or printer type is set to ESC-P, ESC-P2, PCL5, or BJ.

**ON:** Outputs in color, the same as on the screen. (However, the background is omitted, and grids and other outlines are printed in black).

**OFF:** Prints the image using the same colors as the image printed using the built-in printer.

**Note**

- 
- The instrument does not detect “out of paper” and printer errors on the USB printer. If an error occurs, press the COPY key again to stop the printing.
  - Images may not print properly on some printers. Use USB printers that have been tested for compatibility.
  - You can also print to a USB printer that is connected to your PC. In this case, save the screen image data to a floppy disk, PC card, or other storage medium (see section 12.9), load the data into your PC, and print the data.
-

# 11.4 Printing Using a Network Printer (Optional)

## Procedure

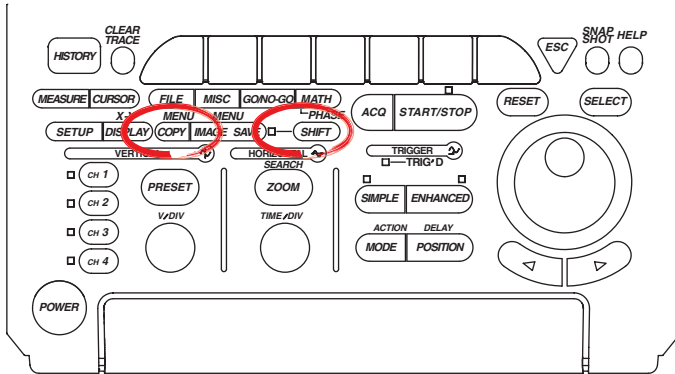

- To exit the menu during operation, press **ESC** located above the soft keys.
- In the procedural explanation below, the term **jog shuttle & SELECT** refers to the operation of selecting/setting items and entering values using the **jog shuttle** and **SELECT** and **RESET** keys. For details on this operation, see sections 4.1 and 4.2.
- For a description of the operation using a USB keyboard or a USB mouse, see section 4.3.

### Network Settings

1. After making a network connection (see section 13.1), enter TCP/IP settings (see section 13.2) and settings for printing screen images to a network printer (see section 13.4.).

### Selecting a Network Printer

2. Press **SHIFT+COPY(MENU)**. The COPY menu appears.
3. Press the **Copy to** soft key. The Copy to menu appears.

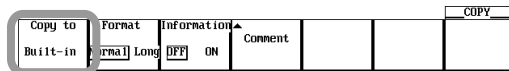

4. Press the **Net Print** soft key.  
Built-in and Net Print appear if the built-in printer option and the Ethernet interface option are installed, respectively.

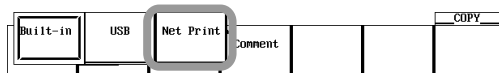

### Selecting the Page Description Language or Printer Type

5. Press the **Format** soft key. The Format menu appears.

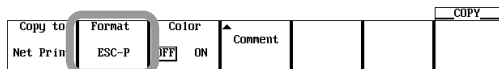

6. Press **Post Script, LIPS3, PCL5, ESC-P, ESC-P2, or BJ** to select the page description language or the printer type.

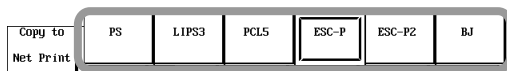

**Turning Color Printing ON and OFF**

(Selectable only if the page description language or printer type is set to PCL5, ESC-P, ESC-P2, or BJ in step 6)

7. Press the **Color** soft key to select ON or OFF.



**Entering Comments**

8. Press the **Comment** soft key. A keyboard used to enter values and strings appears.
9. Use **jog shuttle & SELECT** to set the comment.

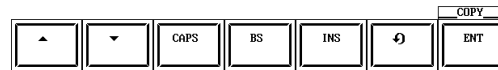
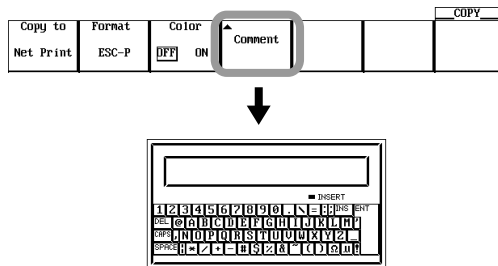

**Selecting the Output Resolution**

(Selectable only if the page description language or printer type is set to BJ in step 6)

10. Press the **Resolution** soft key. The Resolution menu appears.

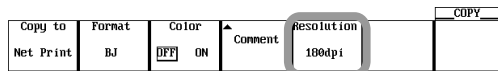

11. Press the **180dpi**, **300dpi**, **360dpi**, or **600dpi** soft key to set the output resolution.



**Printing**

12. Press **COPY**. The screen image is printed on the network printer. To abort printing, press **COPY** while printing is in progress.

While printing is in progress,  is indicated at the upper left corner of the screen.

### ***Explanation***

Like the built-in printer, you can print the screen image on a network printer\* via the Ethernet network.

\* Printing is possible on a printer or via a printer server supporting the TCP/IP protocol.

### **Page Description Language or Printer Type: Format**

You can select the page description language and printer type.

Post Script, LIPS3, PCL5, ESC-P, ESC-P2, or BJ (can be used on models that support the BJC- 35 V native commands)

### **Output Resolution**

(Only when the page description language or printer type is set to BJ)

You can select the print resolution of screen images to match the resolution of the BJ printer on the network.

180dpi, 300dpi, 360dpi, 600dpi

### **Comment**

A comment text of up to twenty characters can be printed at the bottom of the print page.

The entered comment is displayed at the lower right section of the screen.

### **Turning Color Printing ON and OFF**

You can select whether to print in color only if the page description language or printer type is set to PCL5, ESC-P, ESC-P2, or BJ.

ON: Outputs in color, the same as on the screen. (However, the background is omitted, and grids and other outlines are printed in black).

OFF: Prints the image using the same colors as the image printed using the built-in printer.



# 12.1 Storing and Recalling Setup Data

## Procedure

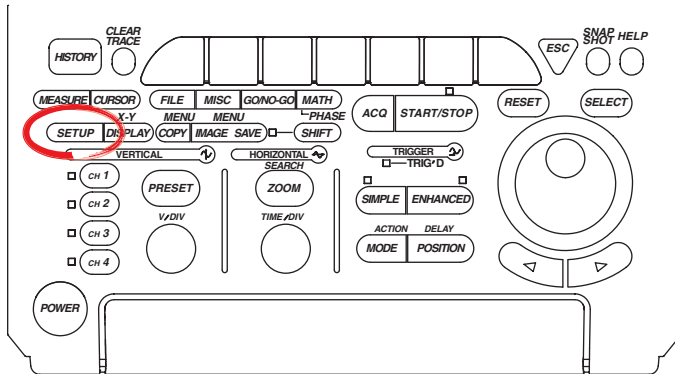

- To exit the menu during operation, press **ESC** located above the soft keys.
- For a description of the operation using a USB keyboard or a USB mouse, see section 4.3.

1. Press **SETUP**. The SETUP menu appears.
2. Press the **Store/Recall** soft key. The Str/Rcll menu appears.

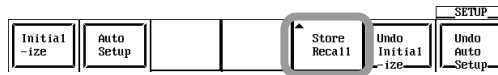

### Storing

3. Press any soft key from **Store #1 to Store #3** to store the setup data. When the setup data is stored, the date of storage is displayed in the soft key menu.



4. Press the **Store Detail** soft key to display the details of the store operation. To enter a comment, follow the procedure described in section 4.2. There is a lock switch that you can use to protect (lock) overwriting the stored data. Turn the **jog shuttle** to move the cursor to the lock button corresponding to the store number that you wish to lock. Press **SELECT** to lock the data. Press **SELECT** again to release the lock.

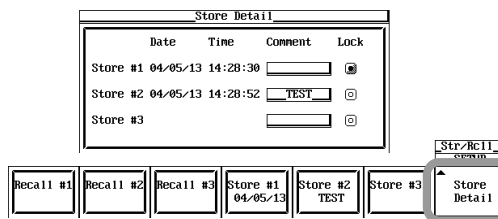

### Recalling

3. Press one of the soft keys **Recall #1 to Recall #3** to recall the setup data.



## 12.1 Storing and Recalling Setup Data

---

### ***Explanation***

#### **Stored Items**

All of the information that you entered using the soft key menu or jog shuttle menu, START/STOP, and the ON/OFF conditions of channels are stored.

#### **Selecting the Storage Destination of the Setup Data**

You can store data to any of three internal memories, Store #1 to Store #3. If setup data is already stored, the stored data is overwritten with the new data. However, an error message is displayed if the data is locked.

#### **Selecting Setup Data to Recall**

You can select stored data from any of three internal memories, Store #1 to Store #3. You can only select a memory to which setup data was stored.

#### **Note**

---

The stored setup data is not cleared even if you initialize the settings on the instrument.

---

---

## 12.2 Floppy Disks and PC Cards

A floppy disk drive or PC card (either type is selected at the time of purchase) is available as an internal storage medium.

### Floppy Disks

#### Floppy Disks That Can Be Used

The following type of 3.5" floppy disk can be used. Formatting is also possible on the instrument.

2HD: Formatted to 1.44 MB using MS-DOS.

#### Inserting a Floppy Disk into the Floppy Disk Drive

Turn the disk so that the label faces left, and insert shutter-first into the slot. Insert the disk until the eject button pops out.

#### Removing the Disk from the Floppy Disk Drive

Check that the access indicator is turned OFF and press the eject button.

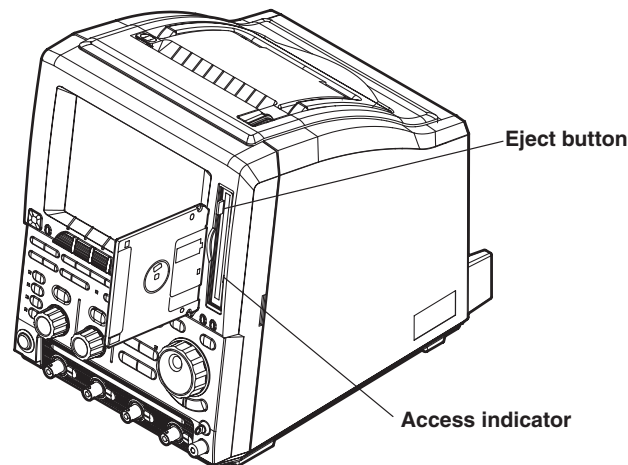

---

### CAUTION

Do not remove the floppy disk or turn the instrument OFF when the access indicator is illuminated. Doing so can damage the storage medium or destroy the data on the medium.

---

#### General Handling Precautions of Floppy Disks

Floppy disks with bad sectors cannot be used on the instrument. Format the floppy disk using your PC or other device before use.

For the general handling precautions of the floppy disk, read the instruction manual that came with the floppy disk.

### PC Cards

#### PC Cards That Can Be Used

The instrument supports flash ATA cards (PC card TYPE II) and compact flash (using the PC card TYPE II adapter). In addition, some of the Flash ATA hard disk drive cards can be used.

For details, contact the dealer from which you purchased the instrument.

#### Note

To use the PC card on the PC, use a PC that supports the PC card. Depending on the PC that you are using, the PC cards indicated above may not operate properly. Confirm this beforehand.

---

#### Inserting the PC Card

With the face of the PC card facing left, insert the card into the PC card drive.

#### Note

Insert the PC card securely, all the way into the slot. If it is not inserted completely, the instrument may not be able to recognize it.

---

#### Ejecting the PC Card

Check that the PC card is not being accessed, and press the eject button above the PC card slot.

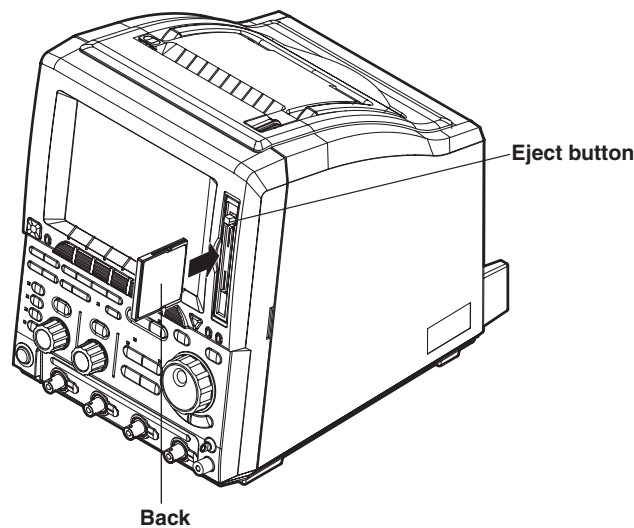

---

### CAUTION

---

- The instrument may malfunction if the PC card is inserted and ejected within a one-second time period.
  - Do not remove the PC card or turn the power to the instrument OFF while the card is being accessed. Doing so can destroy the data on the medium.
  - While the PC card is being accessed, an "accessing" icon appears in the upper left part of the screen.
-

**General Handling Precautions of PC Cards**

For the general handling precautions of the PC card, read the instruction manual that came with the PC card.

## 12.3 Connecting USB Storage (MO Disk Drive, Hard Disk, Flash Memory) to the USB PERIPHERAL Interface

### Specifications of the USB PERIPHERAL Interface

Item	Description
Connector type	USB type A connector (receptacle)
Electrical and mechanical	USB Rev. 1.1
Data rate	12 Mbps max.
Power supply	5 V, 500 mA* (per port)
Number of ports	2

\* Devices with maximum consumption currents exceeding 100 mA cannot be connected to two ports at the same time.

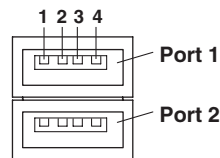

Pin No.	Signal Name
1	VBUS: -5 V
2	D- +Data
3	D+ -Data
4	GND: Ground

### Connecting USB Storage

When connecting USB storage, directly connect the storage device to the instrument using a USB hub as shown below. You can connect the USB cable regardless of whether the power to the instrument is ON or OFF (supports hot-plugging). When the power switch is ON, the USB storage device is detected and enabled approximately six seconds after it is connected.

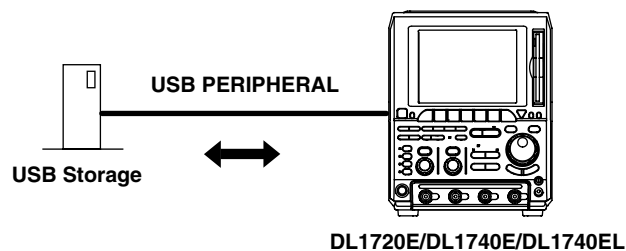

### Compatible USB Storage

The instrument is compatible with USB mass storage class devices including hard disk drives, MO drives, and flash memory devices.

### Note

- Do not connect USB devices other than a USB keyboard, USB mouse, USB printer, or USB storage device to the USB PERIPHERAL connector.
- The instrument has two USB PERIPHERAL connectors, but two USB devices with maximum consumption currents exceeding 100 mA cannot be connected at the same time.

---

### **CAUTION**

- Do not remove the USB storage device or turn the power to the instrument OFF while the device is being accessed. Doing so can destroy the data on the medium.
  - While the USB storage device is being accessed, an “accessing” icon appears in the upper left part of the screen.
- 

#### **General Handling Precautions of USB Storage**

For the general handling precautions of the USB storage device, read the instruction manual that came with the device.

## 12.4 Formatting the Storage Medium



### CAUTION

- Do not remove the storage medium (disk) or turn OFF the power when the access indicator or icon of the storage medium is blinking. Doing so can damage the storage medium or destroy the data on the medium.
- If the instrument cannot recognize a formatted medium, format the disk again on the instrument. Note that all the data on the storage medium are cleared when the storage medium is formatted. Be sure to back up important data beforehand.

### Procedure

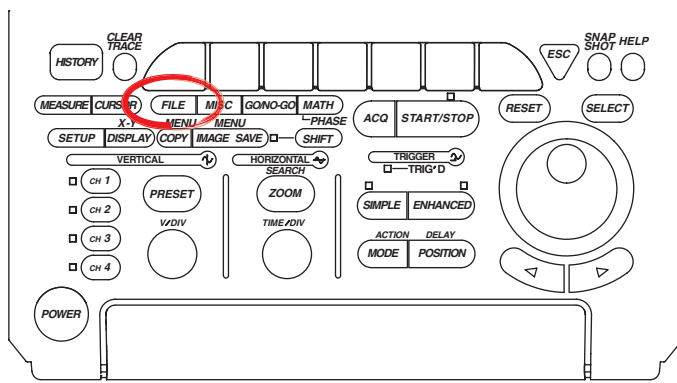

- To exit the menu during operation, press **ESC** located above the soft keys.
- In the procedural explanation below, the term **jog shuttle & SELECT** refers to the operation of selecting/setting items and entering values using the **jog shuttle** and **SELECT** and **RESET** keys. For details on this operation, see sections 4.1 and 4.2.
- For a description of the operation using a USB keyboard or a USB mouse, see section 4.3.

- Press **FILE**. The FILE menu appears.
- Press the **Utility** soft key to display the Utility menu and the File List window.

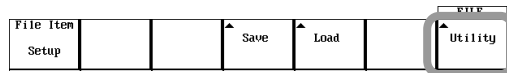

### Selecting the Storage Medium to Be Formatted

- Press the **Function** soft key. The Function menu appears.

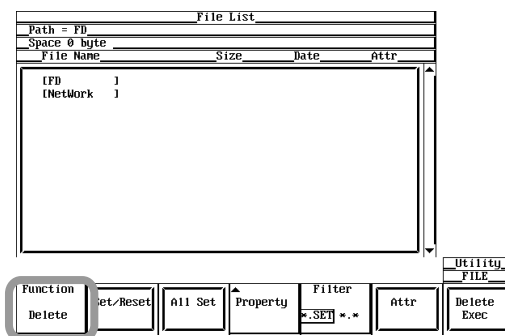

- Press the **Format** soft key. A media list is displayed in the File List window.

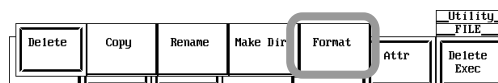



5. Turn the **jog shuttle** to select the storage medium to be formatted.  
 Network drives cannot be formatted.  
 If there are no external USB storage devices that are detected and only a floppy disk, or PC card is inserted, only FD, or PC\_CARD appears.

File List		
File Name	Size	Space
FD	1457664	585216

**Selecting the Floppy Disk Format**

6. Press the **Format** soft key. The Format menu appears.  
 Proceed to step 8.

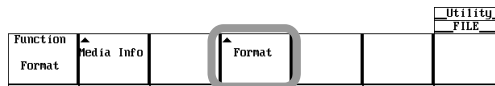

**Selecting the PC Card Format**

6. Press the **Format** soft key. The Format menu appears.



**Selecting the Number of Partitions**

7. Turn the **jog shuttle** to select 1 or 2.  
 Storage media that are already partitioned can be selected and formatted as separate storage media (PC\_Card1 or PC\_Card2, for example), but the separate storage media cannot be partitioned further.



**Selecting the USB Storage Format**

6. Press the **Format** soft key. The Format menu appears.



**Selecting the Number of Partitions**

7. Turn the **jog shuttle** to select a value in the range of 1 to 3.  
 Storage media that are already partitioned can be selected and formatted as separate storage media, but the separate storage media cannot be partitioned further.

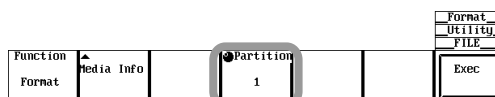

## 12.4 Formatting the Storage Medium

### Executing (OK)/Aborting (Cancel) the Format Operation

- Press the **Exec** soft key. The Alert dialog box opens.

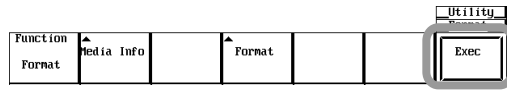

- Use **jog shuttle & SELECT** to select OK (execute) or Cancel.

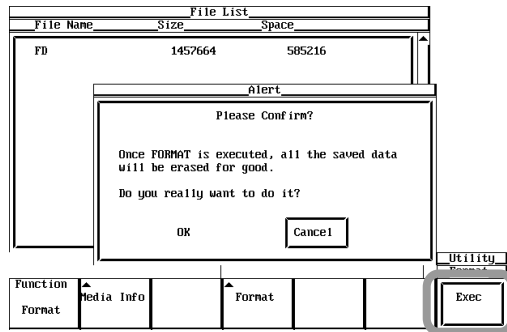

### Displaying Media Information

Select the storage medium according to steps 1 to 5 on page 12-8.

- Press the **Media Info** soft key. The information about the storage medium that was selected in step 5 is displayed.

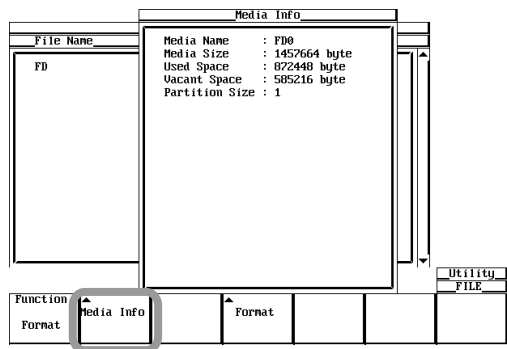

**Explanation****Formatting a Floppy Disk**

When using a new floppy disk, you must format it. You can format the disk to 2HD 1.44M.

**Formatting a PC Card/Initializing USB Storage**

PC cards and USB storage are initialized in FAT format.

**Number of Partitions**

You can set partitions on external USB storage devices and PC cards. However, partitions cannot be specified on external USB storage devices and PC cards handled as removable disks. In addition, a storage medium that is already partitioned can be selected and formatted as a separate storage medium, but the separate storage medium cannot be partitioned further.

On external USB storage devices, you can select 1 to 3 partitions; on PC cards, you can select 1 or two partitions.

**Media Information**

Lists the information about the selected medium.

Media Name	Name of the medium
Media Size	Media size
Used Space	Used space
Vacant Space	Total size
Partition Size	Number of partitions
Vendor Name	Manufacturer name (only on external USB storage devices)
Product Name	Product name (only on external USB storage devices)

**Note**

- If you format a storage medium that has data stored on it, all of the stored data are cleared. Use caution when formatting a storage medium.
- It takes approximately a minute and a half to format a floppy disk.
- It takes a few seconds to format a PC card.
- You cannot format a floppy disk if the write-protect is ON.
- Floppy disks that are formatted to formats other than those listed in this section cannot be used.
- If an error message is displayed after the format operation, the floppy disk may be damaged.
- You can use floppy disks that are formatted on a PC under MS-DOS.
- This function cannot be used when using the FTP server function, FTP client function, the LPR client function, or the Web server function.

## 12.5 Saving/Loading the Waveform Data



### CAUTION

Do not remove the storage medium (disk) or turn OFF the power when the access indicator or icon of the storage medium is blinking. Doing so can damage the storage medium or destroy the data on the medium.

### Procedure

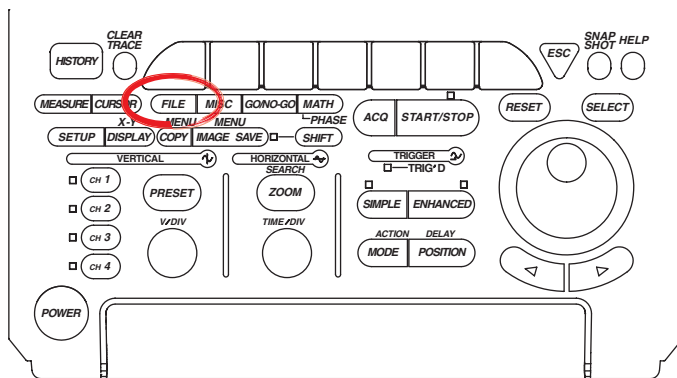

- To exit the menu during operation, press **ESC** located above the soft keys.
- In the procedural explanation below, the term **jog shuttle & SELECT** refers to the operation of selecting/setting items and entering values using the **jog shuttle** and **SELECT** and **RESET** keys. For details on this operation, see sections 4.1 and 4.2.
- For a description of the operation using a USB keyboard or a USB mouse, see section 4.3.

1. Press **FILE**. The FILE menu appears.
2. Press the **File Item** soft key. The File Item setting menu appears.

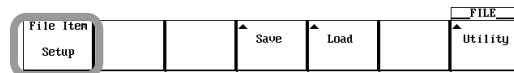

3. Press the **Waveform** soft key.

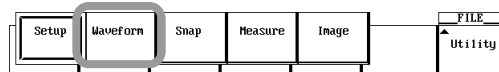

### Saving the Waveform Data

#### Selecting the Data Type

4. Press the **Data Type** soft key. The Data Type menu appears.

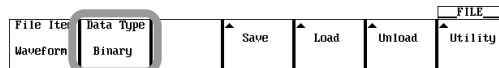

5. Press the **Binary**, **ASCII**, or **Float** soft key to select the data type. Only the data saved in binary can be loaded (as described later).

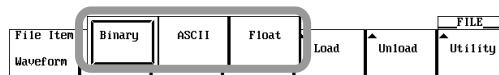

**Selecting the Waveform to Be Saved**

6. Press the **Save** soft key. The Save menu appears.



7. Press the **Trace** soft key. The Trace menu appears.



8. Press the soft key corresponding to the channel of the waveform to be saved.

- If you select All, all the channels are saved.
- CH3, CH4, and Math2 are not displayed on the DL1720E.

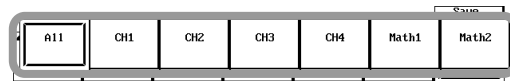

**Selecting the Range of the Waveform to Be Saved**

9. Press the **Range** soft key. The Range menu appears.

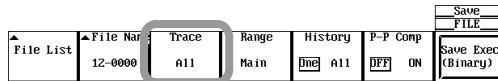

10. Press one of the soft keys **Main** to **Z1&Z2** to select the range of the waveform to be saved.



11. Press the **History** soft key to select whether to save all the data in the history memory (All) or save only the selected waveform (One).

If you select All after searching the history memory data, only the waveforms that are found are saved.



**Compressing Data (When Binary Is Selected for the Data Type)**

12. Press the **P-P Comp** soft key to select ON or OFF.

- If you select ON, the data is compressed and saved.
- If you select OFF, the data is saved without compression.
- If P-P Comp is turned ON when saving waveform data, only the maximum and minimum values of the multiple data points existing at the same time position are saved. Consequently, the file size is reduced.

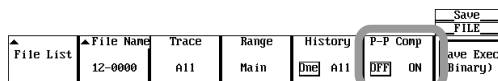

## 12.5 Saving/Loading the Waveform Data

### Selecting the Save Destination Medium/Directory

13. Press the **File List** soft key to display the File List window.
14. Use **jog shuttle & SELECT** to select the save destination medium (indicated by brackets).

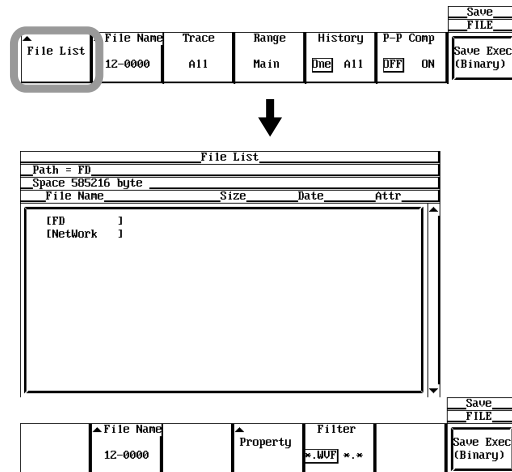

### Selecting the Save Destination Directory

Perform this operation when directories are present on the medium.

15. Use **jog shuttle & SELECT** to select the save destination directory (indicated by < >).

The selected medium/directory is displayed in "Path=....." located in the upper-left of the File List window.

Select <..> to move to the parent directory.

### Setting the File Name and Comment

16. Press the **File Name** soft key. The File Name&Comment dialog box opens.

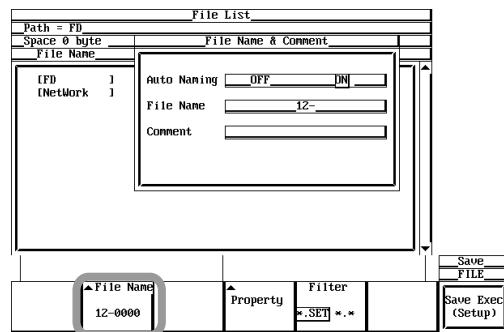

17. Use **jog shuttle & SELECT** to set the auto naming function.
  - If you select ON, the auto naming function is enabled.
  - If you select OFF, the auto naming function is disabled.
18. Use **jog shuttle & SELECT** to call up the keyboard and set the file name or comment.
  - Enter the file name using up to fourteen characters.
  - Enter comment using up to twenty-five characters.
19. Press **ESC**. The File Name&Comment dialog box closes.

**Executing the Save**

20. Press the **Save Exec** soft key. The data is saved to the directory indicated by Path=..... At the same time, the Save Exec soft key changes to the Abort soft key. While the data is being saved, the  icon is displayed at the upper left corner of the screen.

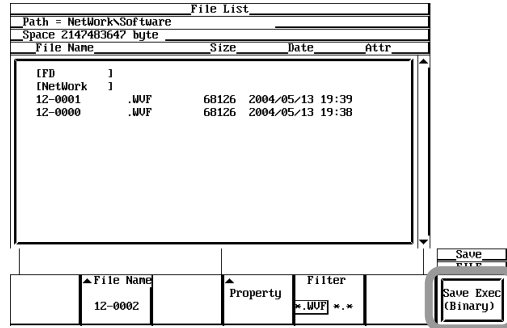

**Aborting the Save**

21. Press the **Abort** soft key. The save operation is aborted. At the same time, the Abort soft key changes to the Save Exec soft key.

**Specifying the File and Properties to Be Displayed on the File List Window**

22. On the screen showing the File List window, press the **Filter** soft key to select the extension or \*.\*.
  - If you select the \*.extension (WVF, CSV, or FLD), only the files that have the same file format as the file being saved are displayed.
  - If you select \*.\* , all the files in the directory are displayed.



23. Turn the **jog shuttle** to select the files in the File List window.
24. Press the **Property** soft key. Information about the selected file is displayed.

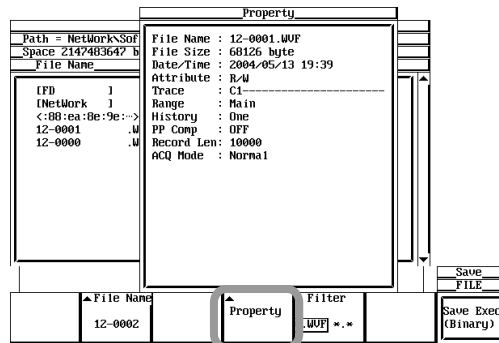

25. Press **ESC**. The window showing the information closes.

**Loading the Waveform Data**

Set the data type to Binary. For the setup procedure, see steps 4 and 5 on page 12-12.

6. Press the **Load** soft key. The Load menu and the File List window appear.

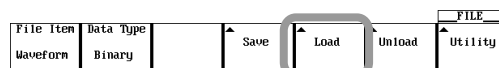

## 12.5 Saving/Loading the Waveform Data

### Selecting the Load Source Medium/Directory

- The procedure is the same as steps 14 to 15 on page 12-14.

### Selecting the File to Be Loaded

- Turn the **jog shuttle** to select a file.

### Executing the Load Operation

- Press the **Load Exec** soft key. The selected file is read from the directory indicated in Path=..... At the same time, the Load Exec soft key changes to the Abort soft key.

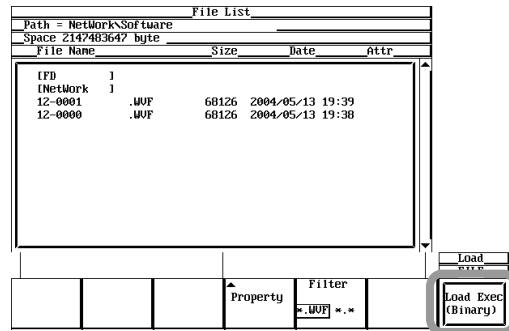

### Aborting the Load Operation

- Press the **Abort** soft key. The load operation is aborted. At the same time, the Abort soft key changes to the Load Exec soft key.

### Specifying the File and Properties to Be Displayed on the File List Window

- The procedure is the same as steps 22 to 25 on page 12-15.

## Unloading the Waveform Data

### Selecting a Waveform to Unload

- After step 5 of page 12-12, press the **Unload** soft key. The Unload menu is displayed.

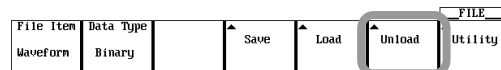

- Press the **Trace** soft key. The Trace menu appears.



- Press the **All, CH1 to CH4(2), Math1, or Math2** soft key to select the waveform to Unload.

- On the DL1740E/DL1740EL, you can select from All, CH1 to CH4, Math1, and Math2.
- On the DL1720E, you can select All, CH1, CH2, and Math1.
- Pressing All will select all channels for unloading.

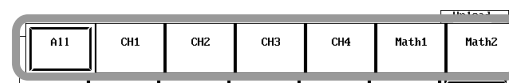



**Executing the Unload Operation**

9. Press the **Unload Exec** soft key. The unload operation is executed.

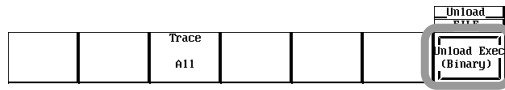

**Explanation**

**Data Type and Extension**

• **Binary**

- The sampled data in the acquisition memory is saved in binary format.
- The data that is saved can be loaded to display the waveform and compute numeric data.
- A header file that is used when analyzing the waveform on a PC is automatically created. The header file cannot be opened on the instrument. For details on the header file format, see appendix 3.
- The extension is .WVF. The extension of the header file name is .HDR.
- When saving waveform data in binary format, a header file is automatically created with the extension .HDR. When the instrument is used to copy, delete, change the names of, or change the file attribute of waveform data files (files with .WVF extension), the header files are automatically updated to reflect the changes. Do not delete only the header file or only the waveform data file, as this may cause a system malfunction.

• **ASCII**

- The units of the sampled data in the acquisition memory are converted per the specified range and saved in ASCII format. The data can be used to analyze the waveform on a PC.
- The file cannot be loaded into the instrument.
- The extension is .CSV.

• **Float**

- The units of the sampled data in the acquisition memory are converted per the specified range and saved in 32-bit floating format. The data can be used to analyze the waveform on a PC.
- The order of the data is little-endian (Intel format).
- The file cannot be loaded into the instrument.
- The extension is .FLD.

**Data Size**

The following table shows the data size when the record length is set to 100 kW, waveform data of CH1 to CH4 are saved, MATH1 and MATH2 are turned OFF, and using history waveform 1 condition.

Data Type	Extension	Data Size (Bytes)
Binary	.WVF	Approx. 850 K $((100 \text{ kW} + 32) \times \text{four channels} \times \text{the number of history waveforms} \times 2 + 46 \text{ K})$
	.HDR	Approx. 2 K (approx. 3 K when Math1 and Math2 are ON)
ASCII	.CSV	4 to 5 M byte
Float	.FLD	Approx. 1.6 M $((100 \text{ kW} + 32) \times \text{four channels}) \times \text{the number of history waveforms} \times 4)$

## 12.5 Saving/Loading the Waveform Data

---

### Waveforms to Be Saved

- You can save all the waveforms or the selected waveform from CH1 to CH4(2), Math1, and Math2 (or CH1 CH2, and -Math1 on the DL1720E).
- The setup data including vertical axis, horizontal axis, and trigger of the waveform to be saved is also saved.
- For waveforms that are loaded using the history memory function, you can select whether to save all of the history waveforms or save just the current displayed waveform on the screen. You can also save only the results obtained by searching the history waveforms. For a description of searching the history waveforms, see section 10.2 or 10.3.
- For a description of snapshot waveforms, see section 12.7.

### Range of Waveform to Be Saved

You can select the range (area) of a waveform to be saved. Only the data that has been saved by selecting Binary in the aforementioned section “Data Type and Extension” can be loaded into the instrument.

- Main: The range of the normal (Main) waveform. It is the range defined by the display record length (range displayed on the screen).
- Z1: The range of zoom waveform Z1.
- Z2: The range of zoom waveform Z2.
- Z1&Z2: The range of zoom waveforms Z1 and Z2.

### Data Compression

- You can select whether to P-P compress the waveform data before saving.
- Power spectrum computation data cannot use P-P compression.

### Storage Medium and Directory

Storage media which saving and loading are possible are displayed on the File List window. Display Examples of Storage Media

- **Floppy Disk**
  - FD: Floppy disk
  - PC Card: PC card
  - NetWork: Network drive (when the Ethernet interface option is installed)
  - USB: USB storage

### Auto Naming

When Auto Naming is turned ON, files with a four digit number from 0000 to 2399 (0000 to 1199 for binary format) are automatically created when saving the data. You can specify a common name (up to ten characters, specified through Filename) that is placed before the number.

### File Name and Comment

- A file name must be assigned. Comments are optional.
- You cannot save to a file name that already exists in the same directory (overwriting not allowed).

### Number and types of characters that can be used

Item	Number of Characters	Characters That Can Be Used
File name	1 to 14 characters	0 to 9, A to Z, %, _, (, ), -
Comment	0 to 25 characters	All characters (including spaces)

### Specifying the File to Be Displayed on the File List Window

Specify the type of files to be displayed.

- \*.WVF/\*.CSV/\*.FLD  
Displays only the files that have the same file format as the file being saved.
- \*.\*  
Displays all the files in the directory.

**Properties**

Displays information about the selected file including the name, extension, the file size, the date the file was saved, the attribute, and the comment.

**Unload**

When waveform data is loaded and displayed, newly acquired data are not displayed even when waveform acquisition is started. To display the newly acquired waveforms, you must unload the data that has been loaded into the respective channel.

**Note**

- An error occurs if a key other than the Abort key is pressed while saving or loading a file.
- Saving and loading is not possible while waveform acquisition is in progress.
- If you change the extension of the data saved (on a PC, for example), the file can no longer be loaded.
- Files that do not have an archive attribute are not displayed in the File List window. Do not remove the archive attribute of the files saved by the instrument using your PC.
- Up to forty-two characters can be displayed in the path.
- File names are not case-sensitive. Comments are case-sensitive. In addition, the following file names cannot be used due to limitations of MS-DOS.  
AAUX, CON, PRN, NUL, CLOCK, COM1 to COM9, and LPT1 to LPT9
- The waveform data loaded from a file overwrites the waveform data in the acquisition memory. Once the memory is overwritten, the old data cannot be recovered. It is recommended that the current waveform data be saved before loading data from a file.
- Loaded waveforms are cleared only when Unload, Initialize, or Auto Setup is executed or when the waveform acquisition condition is changed.
- If the total number of files and directories exceeds 2500 in a single directory, the file list is no longer displayed.
- This function cannot be used when using the FTP server function, FTP client function, the LPR client function, or the Web server function.
- Files with the extension .WVF and .HDR are saved as file pairs. If you specify “...” for the files to be displayed (Filter) on the File List and manipulate individual files (Delete, Rename, or Copy), the files can no longer be loaded.

**Data Format When Storing Multiple Records**

When multiple records are stored (in history memory, for example), the following data format is used.

**ASCII format: CR+LF between records**

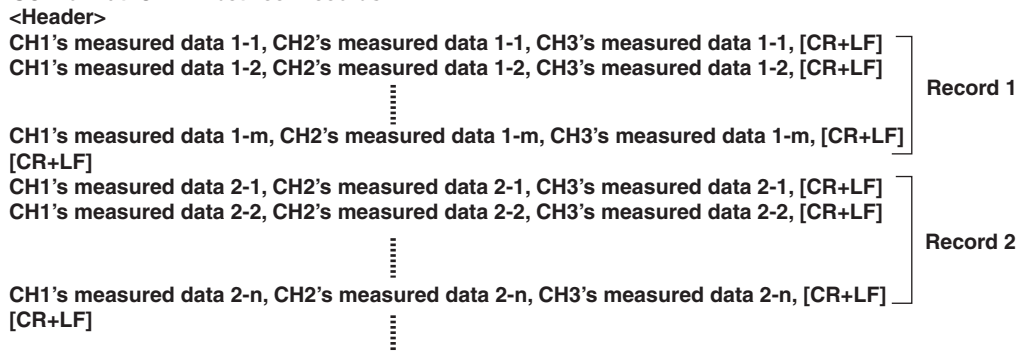

**Float format: data saved together by channel**

Measured data of CH1, record 1
Measured data of CH1, record 2
⋮
Measured data of CH1, record N
Measured data of CH2, record 1
Measured data of CH2, record 2
⋮
Measured data of CH2, record N
⋮

## 12.6 Saving/Loading Settings



### CAUTION

Do not remove the storage medium (disk) or turn OFF the power when the access indicator or icon of the storage medium is blinking. Doing so can damage the storage medium or destroy the data on the medium.

### Procedure

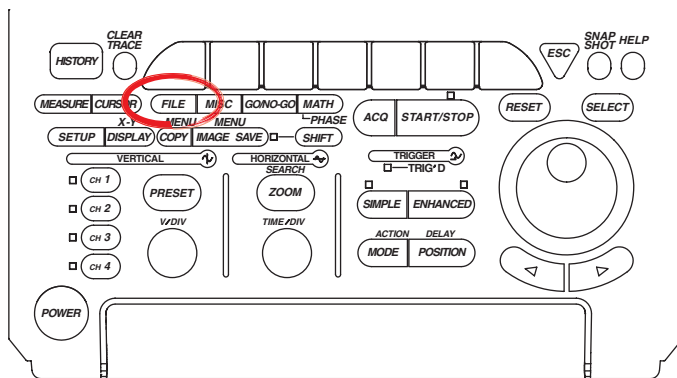

- To exit the menu during operation, press **ESC** located above the soft keys.
- In the procedural explanation below, the term **jog shuttle & SELECT** refers to the operation of selecting/setting items and entering values using the **jog shuttle** and **SELECT** and **RESET** keys. For details on this operation, see sections 4.1 and 4.2.
- For a description of the operation using a USB keyboard or a USB mouse, see section 4.3.

1. Press **FILE**. The FILE menu appears.
2. Press the **File Item** soft key. The File Item setting menu appears.

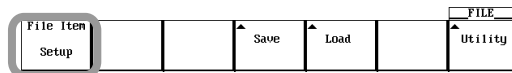

3. Press the **Setup** soft key.

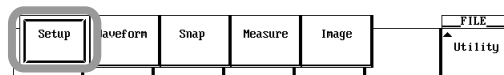

### Saving the Setup Data

Selecting the Save Destination Medium/Directory

4. Press the **Save** soft key. The Save menu appears.



5. Press the **File List** soft key to display the File List window.
6. Use **jog shuttle & SELECT** to select the save destination medium (indicated by brackets).

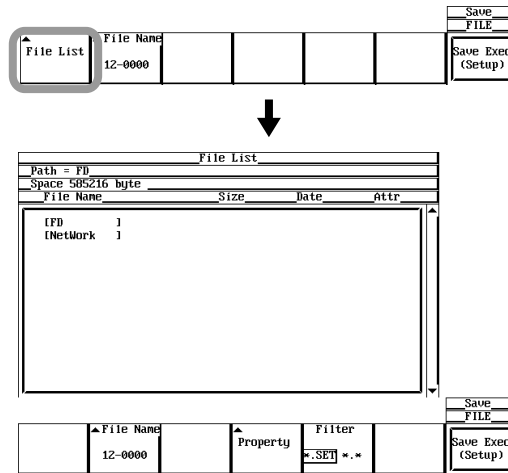

**Selecting the Save Destination Directory**

(Perform this operation when directories are present on the medium.)

7. Use **jog shuttle & SELECT** to select the save destination directory (indicated by < >).  
The selected medium/directory is displayed in “Path=.....” located in the upper-left of the File List window.  
Select <..> to move to the parent directory.

**Setting the File Name and Comment**

8. Press the **File Name** soft key. The File Name&Comment dialog box opens.

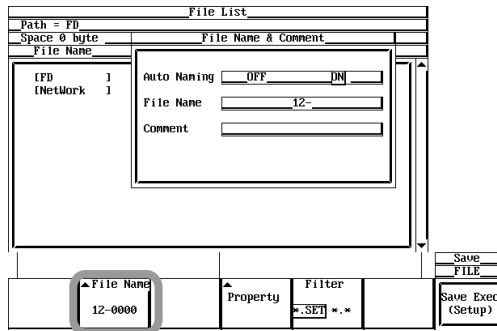

9. Use **jog shuttle & SELECT** to set the auto naming function.
  - If you select ON, the auto naming function is enabled.
  - If you select OFF, the auto naming function is disabled.
10. Use **jog shuttle & SELECT** to call up the keyboard and set the file name or comment.
  - Enter the file name using up to fourteen characters.
  - Enter comment using up to twenty-five characters.
11. Press **ESC**. The File Name&Comment dialog box closes.

**Executing the Save**

12. Press the **Save Exec** soft key. The data is saved to the directory indicated by Path=..... At the same time, the Save Exec soft key changes to the Abort soft key. While the data is being saved, the  icon is displayed at the upper left corner of the screen.

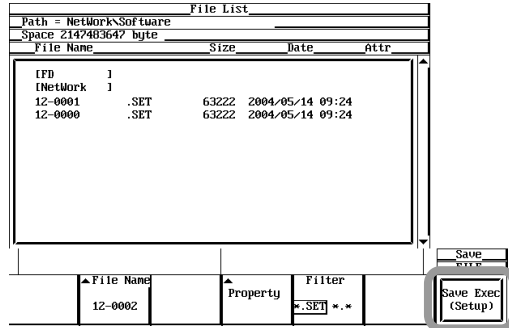

**Aborting the Save**

13. Press the **Abort** soft key. The save operation is aborted. At the same time, the Abort soft key changes to the Save Exec soft key.

**Specifying the File and Properties to Be Displayed on the File List Window**

14. On the screen showing the File List window, press the **Filter** soft key to select the \* or \* extension.
  - If you select \*.SET, only setup data files are displayed.
  - If you select \*.\* , all the files in the directory are displayed.



15. Turn the **jog shuttle** to select the files in the File List window.
16. Press the **Property** soft key. Information about the selected file is displayed.

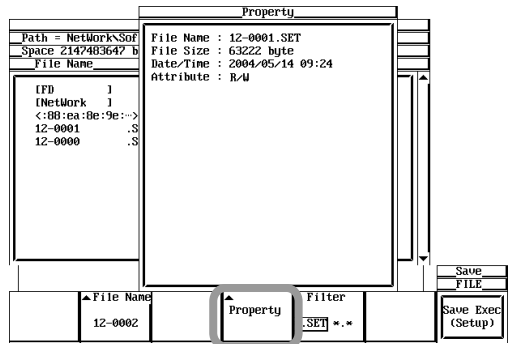

17. Press **ESC**. The window showing the information closes.

## Loading the Setup Data

Select the setup data according to steps 1 to 3 on page 12-20.

- Press the **Load** soft key. The Load menu and the File List window appear.

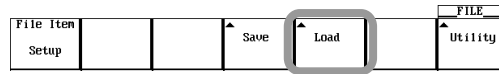

### Selecting the Load Source Medium/Directory

- The procedure is the same as steps 6 to 7 on page 12-21.

### Selecting the File to Be Loaded

- Turn the **jog shuttle** to select a file.

### Executing the Load Operation

- Press the **Load Exec** soft key. The selected file is read from the directory indicated in Path=..... At the same time, the Load Exec soft key changes to the Abort soft key.

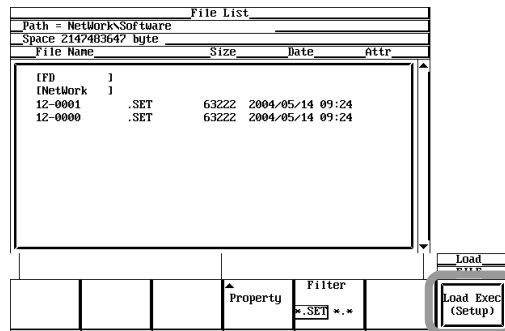

### Aborting the Load Operation

- Press the **Abort** soft key. The load operation is aborted. At the same time, the Abort soft key changes to the Load Exec soft key.

### Specifying the File and Properties to Be Displayed on the File List Window

- The procedure is the same as steps 14 to 16 on page 12-22.

### Explanation

#### Setup Data That Are Saved

The setup data existing at the time the store operation is executed can be saved. However, setup data such as the date/time and communications settings are not saved.

#### Data Size

The size of the setup data is approximately 47 KB. However, if GO/NO-GO determination is performed using zones (see section 10.9), 4 KB of data is added for each registered zone.

#### Storage Medium and Directory

Storage media with which saving and loading are possible are displayed on the File List window.

Display Examples of Storage Media

- **Floppy Disk**

FD: Floppy disk

PC Card: PC card

NetWork: Network drive (when the Ethernet interface option is installed)

USB: USB storage

#### Auto Naming

When Auto Naming is turned ON, files with a four digit number from 0000 to 2399 are automatically created when saving the data. You can specify a common name (up to ten characters, specified through Filename) that is placed before the number.

#### File Name and Comment

- A file name must be assigned. Comments are optional.
- You cannot save to a file name that already exists in the same directory (overwriting not allowed).

#### Number and Types of Characters That Can Be Used

Item	Number of Characters	Characters That Can Be Used
File name	1 to 14 characters	0 to 9, A to Z, %, _, ( , ) , -
Comment	0 to 25 characters	All characters (including spaces)

#### Extension

The .SET extension is automatically added to the file name.

#### Specifying the File to Be Displayed on the File List Window

Specify the type of files to be displayed.

\*.SET: Displays only setup data files.

\*.\*: Displays all the files in the directory.

#### Properties

Displays information about the selected file including the name, extension, the file size, the date the file was saved, the attribute, and the comment.



**Note**

- An error occurs if a key other than the Abort key is pressed while saving or loading a file.
  - Saving and Loading is not possible while waveform acquisition is in progress. Press the START/STOP key to stop the acquisition first.
  - The total number of files and directories that can be displayed in the File List is 2500. The number of files and directories that can be displayed in as single directory is 2500. If the number of items to be displayed exceeds this number, the file list randomly displays 2500 of the directories and files.
  - If you change the extension of the file (using a PC, for example), the file can no longer be loaded.
  - Files that do not have an archive attribute are not displayed in the File List window. Do not remove the archive attribute of the files saved by the instrument using your PC.
  - Up to forty-two characters can be displayed in the path. If forty-two characters are exceeded, “...” is displayed at the end of the characters.
  - File names are not case-sensitive. Comments are case-sensitive. In addition, the following file names cannot be used due to limitations of MS-DOS.  
AAUX, CON, PRN, NUL, CLOCK, COM1 to COM9, and LPT1 to LPT9
  - If the setup data that is saved to a file are loaded, the settings of the menus and dialog boxes are changed to the loaded information and cannot be undone. It is recommended that you first save the current setup data and then load the setup data from a file.
  - Setup data such as the date/time and communications settings are not saved. Therefore, loading setup data from a file will not change these settings.
  - This function cannot be used when using the FTP server function, FTP client function, the network printer function, or the Web server function.
-

## 12.7 Saving/Loading the Snapshot Waveforms



### CAUTION

Do not remove the storage medium (disk) or turn OFF the power when the access indicator or icon of the storage medium is blinking. Doing so can damage the storage medium or destroy the data on the medium.

### Procedure

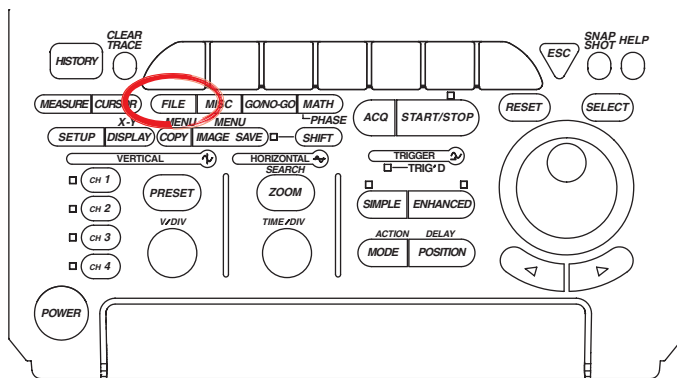

- To exit the menu during operation, press **ESC** located above the soft keys.
- In the procedural explanation below, the term **jog shuttle & SELECT** refers to the operation of selecting/setting items and entering values using the **jog shuttle** and **SELECT** and **RESET** keys. For details on this operation, see sections 4.1 and 4.2.
- For a description of the operation using a USB keyboard or a USB mouse, see section 4.3.

1. Press **FILE**. The FILE menu appears.
2. Press the **File Item** soft key. The File Item setting menu appears.

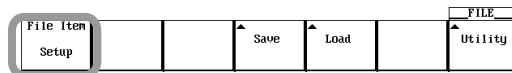

3. Press the **Snap** soft key.



### Saving Snapshot Waveforms

#### Selecting the Save Destination Medium/Directory

4. Press the **Save** soft key. The Save menu appears.



5. The procedure is the same as steps 13 to 15 on page 12-14.

#### Setting the File Name and Comment

6. The procedure is the same as steps 16 to 18 on page 12-14.

**Executing the Save**

- Press the **Save Exec** soft key. The data is saved to the directory indicated by Path=..... At the same time, the Save Exec soft key changes to the Abort soft key. While the data is being saved, the  icon is displayed at the upper left corner of the screen.

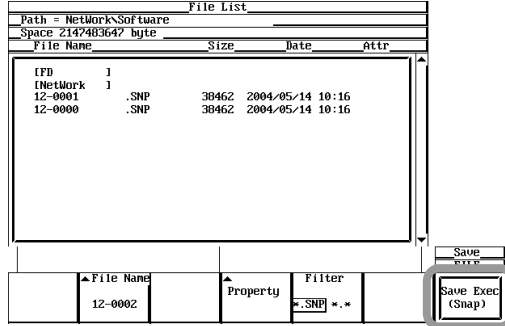

**Aborting the Save**

- Press the **Abort** soft key. The save operation is aborted. At the same time, the Abort soft key changes to the Save Exec soft key.

**Specifying the File and Properties to Be Displayed on the File List Window**

- The procedure is the same as steps 22 to 25 on page 12-15.

**Loading Snapshot Waveforms**

Select the snapshot waveform data according to steps 1 to 3 on page 12-26.

- Press the **Load** soft key. The Load menu and the File List window appear.

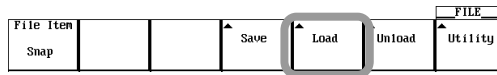

**Selecting the Load Source Medium/Directory**

- The procedure is the same as steps 14 to 15 on page 12-14.

**Selecting the File to Be Loaded**

- Turn the **jog shuttle** to select a file.

**Selecting the Snapshot Waveform to Be Loaded**

- Press the **Destination** soft key. Displays a menu used to select snapshot waveforms.



- Press one of the soft keys **Snap1** to **Snap4** to select the load destination of the snapshot waveform.

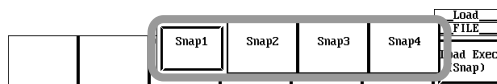

## 12.7 Saving/Loading the Snapshot Waveforms

### Executing the Load Operation

- Press the **Load Exec** soft key. The selected file is read from the directory indicated in Path=..... At the same time, the Load Exec soft key changes to the Abort soft key.

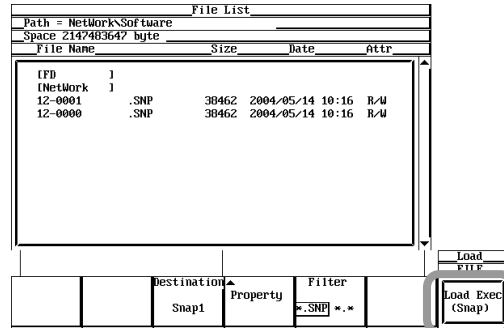

### Aborting the Load Operation

- Press the **Abort** soft key. The load operation is aborted. At the same time, the Abort soft key changes to the Load Exec soft key.

### Specifying the File and Properties to Be Displayed on the File List Window

- The procedure is the same as steps 22 to 25 on page 12-15.

## Clearing Waveforms

Select the snapshot waveform data according to steps 1 to 3 on page 12-26.

- Press the **Unload** soft key. The Unload menu is displayed.

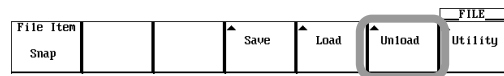

- Press the **Trace** soft key. The Trace menu appears.



- Press the **All** or **Snap1** to **Snap4** soft key to select the load destination to be unloaded.

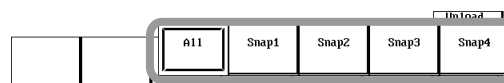

- Press the **Unload Exec** soft key. The selected waveform is cleared.



**Explanation**

You can take snapshots of the waveform and save the image to a file. You can also load the snapshot waveform.

**Data Size**

Approximately 40 KB

**Extension**

The extension is .SNP.

The selection of the medium, directory, file name, comments, auto naming function, specification of the files to be displayed in the File List window, and properties are the same as those for saving/loading normal waveform data. For the explanation and procedure, see section 12.5.

**Loading Snapshot Waveforms**

Snapshot waveforms are loaded to the selected load destination from Snap1 to Snap4.

**Clearing Waveforms**

The loaded snapshot waveforms are cleared when Unload, Initialize, or Auto Setup is executed.

**Note**

- 
- An error occurs if a key other than the Abort key is pressed while saving or loading a file.
  - This function cannot be used when using the FTP server function, FTP client function, the LPR client function, or the Web server function.
-

## 12.8 Saving Automated Measurement Values of Waveform Parameters



### CAUTION

Do not remove the storage medium (disk) or turn OFF the power when the access indicator or icon of the storage medium is blinking. Doing so can damage the storage medium or destroy the data on the medium.

### Procedure

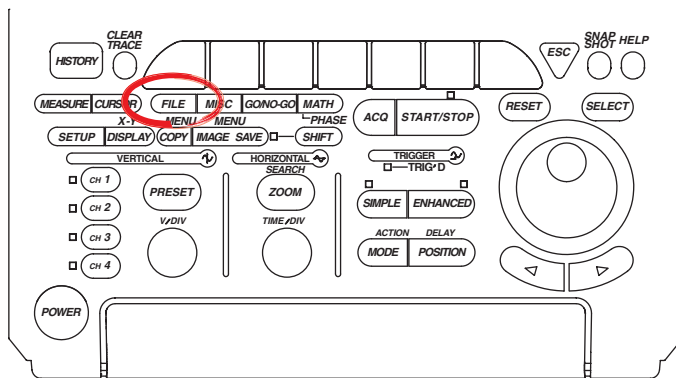

- To exit the menu during operation, press **ESC** located above the soft keys.
- In the procedural explanation below, the term **jog shuttle & SELECT** refers to the operation of selecting/setting items and entering values using the **jog shuttle** and **SELECT** and **RESET** keys. For details on this operation, see sections 4.1 and 4.2.
- For a description of the operation using a USB keyboard or a USB mouse, see section 4.3.

1. Press **FILE**. The FILE menu appears.
2. Press the **File Item** soft key. The File Item setting menu appears.

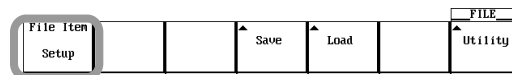

3. Press the **Measure** soft key to select data for automatic measurement.



#### Selecting the Save Destination Medium/Directory

4. Press the **Save** soft key. The Save menu appears.

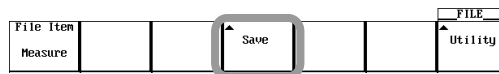

5. The procedure is the same as steps 13 to 15 on page 12-14.

#### Setting the File Name and Comment

6. The procedure is the same as steps 16 to 18 on page 12-14.

**Executing the Save**

- Press the **Save Exec** soft key. The data is saved to the directory indicated by Path=..... At the same time, the Save Exec soft key changes to the Abort soft key. While the data is being saved, the  icon is displayed at the upper left corner of the screen.

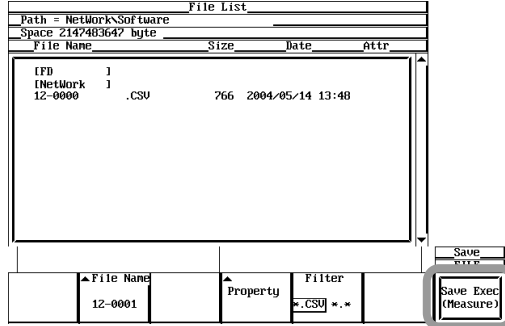

**Aborting the Save**

- Press the **Abort** soft key. The save operation is aborted. At the same time, the Abort soft key changes to the Save Exec soft key.

**Specifying the File and Properties to Be Displayed on the File List Window**

- The procedure is the same as steps 22 to 25 on page 12-15.

**Explanation**

The results of the automated measurement of waveform parameters can be saved to a file in CSV format (.csv extension) to a floppy disk, PC card, or an external USB storage device.

Data in CSV format are saved as comma-separated files. The CSV file is one of the common data formats used to exchange data between spreadsheet and database applications.

\* The data that is saved is the measured results of the parameters that are specified in the automated measurement of waveform parameters.

**Restrictions When Saving the Automated Measurement Values of Waveform Parameters**

When saving, the following restrictions apply.

- Up to [24000/the number of items that are turned ON] data points before the point at which the save operation is executed are saved. However, the data points that are saved are limited to those that are acquired after fixing T/div, V/div, and Measure settings.

**Output Example**

DL1740E:

	"CH1 P-P " "V",	"CH1 Max " "V",	"CH1 Avg " "V",	"CH2 P-P " "V",	"CH2 Max " "V"
Max,	3.708333E+02,	1.833333E+02,	1.439439E+00,	1.133333E+01,	5.750000E+00
Min,	3.625000E+02,	1.791667E+02,	9.124088E-01,	1.125000E+01,	5.583333E+00
Avg,	3.681818E+02,	1.821970E+02,	1.106889E+00,	1.129545E+01,	5.651515E+00
Sdv,	2.678435E+00,	1.855674E+00,	1.885480E-01,	4.149413E-02,	4.791330E-02
Cnt,	1.100000E+01,	1.100000E+01,	5.000000E+00,	1.100000E+01,	1.100000E+01
	,3.708333E+02,	1.833333E+02,	1.439439E+00,	1.125000E+01,	5.583333E+00
	,3.666667E+02,	1.791667E+02,	9.124088E-01,	1.133333E+01,	5.750000E+00
	,3.666667E+02,	1.833333E+02,	9.507383E-01,	1.125000E+01,	5.583333E+00
	,3.666667E+02,	1.791667E+02,	1.066977E+00,	1.125000E+01,	5.666667E+00
	,3.708333E+02,	1.833333E+02,	1.164884E+00,	1.133333E+01,	5.666667E+00

For a description of the automated measurement of waveform parameters, see section 10.6.

## 12.8 Saving Automated Measurement Values of Waveform Parameters

---

### **Data Size**

The data size can be derived from the following equation.

Data size = the number of measurement parameters  $\times$  15  $\times$  the number of history waveforms (bytes)

### **Extension**

The extension is .CSV.

The selection of the medium, directory, file name, comments, auto naming function, specification of the files to be displayed in the File List window, and properties are the same as those for saving/loading normal waveform data. For the explanation and procedure, see section 12.5.

### **Note**

---

- An error occurs if a key other than the Abort key is pressed while saving.
  - This function cannot be used when using the FTP server function, FTP client function, the LPR client function, or the Web server function.
-



## 12.9 Saving Screen Image Data



### CAUTION

Do not remove the storage medium (disk) or turn OFF the power when the access indicator or icon of the storage medium is blinking. Doing so can damage the storage medium or destroy the data on the medium.

### Procedure

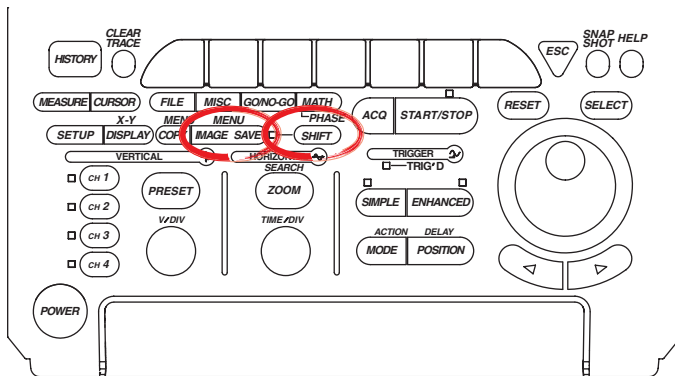

- To exit the menu during operation, press **ESC** located above the soft keys.
- In the procedural explanation below, the term **jog shuttle & SELECT** refers to the operation of selecting/setting items and entering values using the **jog shuttle** and **SELECT** and **RESET** keys. For details on this operation, see sections 4.1 and 4.2.
- For a description of the operation using a USB keyboard or a USB mouse, see section 4.3.

1. Press **SHIFT+IMAGE SAVE (MENU)**. The IMAGE menu appears.

#### Selecting the Data Format

2. Press the **Format** soft key. The Format menu appears.

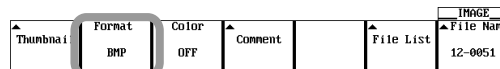

3. Press the **TIFF, BMP, Post Script, PNG, or JPEG** soft key to select the data format.

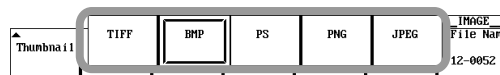

#### Setting the Color Mode

(Selectable only when the data format is set to TIFF, BMP, PNG, or JPEG in step 3)

4. Press the **Color** soft key. The Color menu appears.



5. Press **ON, ON (Reverse) (white background), ON (Gray) (grayscale), or OFF** to select the color mode.

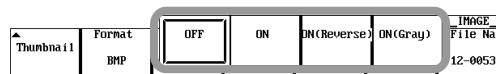

## 12.9 Saving Screen Image Data

### Setting the Compression Method

(Selectable only when the data format is set to BMP in step 3 and the color mode is set to "ON, ON (Reverse) or ON (Gray) in step 5)

- Press the **Compression** soft key to select ON or OFF.



### Entering Comments

- Press the **Comment** soft key. A keyboard used to enter values and strings appears.
- Use **jog shuttle & SELECT** to set the comment.  
Enter comment using up to twenty-five characters.

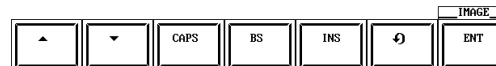
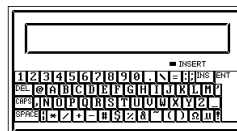

- Press **ESC**.

### Selecting the Storage Medium for Saving

- Press the **File List** soft key. The save destination File List window appears.
- Use **jog shuttle & SELECT** to select the save destination medium (indicated by brackets).

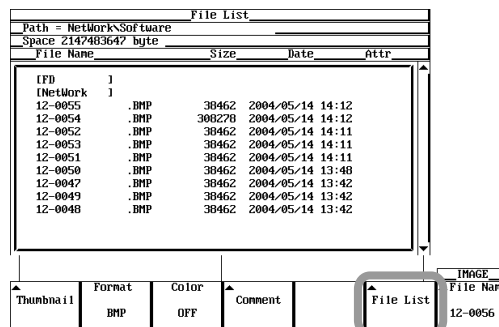

### Selecting the Save Destination Directory

Perform this operation when directories are present on the medium.

- Use **jog shuttle & SELECT** to select the save destination directory (indicated by < >).  
The selected medium/directory is displayed in "Path=....." located in the upper-left of the File List window.  
Select <.> to move to the parent directory.
- Press **ESC**.

### Setting the File Name

14. Press the **File Name** soft key. The file name setup menu appears.

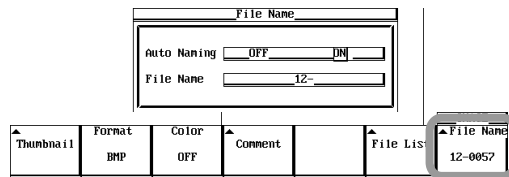

15. Use **jog shuttle & SELECT** to set the auto naming function.
- If you select ON, the auto naming function is enabled.
  - If you select OFF, the auto naming function is disabled.
16. Use **jog shuttle & SELECT** to call up the keyboard and set the file name. Enter the file name using up to fourteen characters.

### Executing/Aborting the Save

17. Press **IMAGE SAVE**. The screen image data is saved to the storage medium. Pressing **IMAGE SAVE** again aborts the save operation. While the data is being saved, the  icon is displayed at the upper left corner of the screen.

### Note

Thumbnails of the saved screen image data can be displayed. For details, see the next section.

## Explanation

The screen image data can be stored to a specified storage medium. You can select a storage medium of floppy disk, PC card, external USB device, or network drive (when the Ethernet interface option is installed). For details on saving data to the network drive, see section 13.3.

### Data Format and Extension

Data in the following formats can be saved to a specified storage medium. The extension that is automatically attached and the data size (reference value) are indicated below.

Data Format	Extension	Data Size <sup>1</sup>
TIFF	*.TIF	Approximately 40 KB (approximately 310 KB) <sup>2</sup>
BMP	*.BMP	Approximately 40 KB (approximately 310 KB) <sup>2</sup>
Post Script	*.PS	Approx. 80 KB
PNG	*.PNG	Approximately 6 KB (approximately 14 KB) <sup>2</sup>
JPEG	*.JPG	Approximately 400 KB (approximately 400 KB) <sup>2</sup>

<sup>1</sup> When color is OFF.

<sup>2</sup> The file size inside the parentheses is for the case when color is ON.

### Color Mode

You can select the color mode only when the data format is set to TIFF, BMP, PNG, or JPEG.

- ON: Output using 256 colors.  
 ON(Reverse): Do not output the background of the screen in color.  
 ON(Gray): Output the data using a tint of sixteen gray levels.  
 OFF: Output in black and white.

### Compress Mode

When the output format is set to BMP, the data can be output by compressing using RLE. However, data is not compressed if the color is OFF.

## 12.9 Saving Screen Image Data

---

### Comment

A comment of up to twenty-five characters can be added to the lower section of the screen and saved. Comments are optional. All characters (including spaces) can be used.

### Save Destination

The available storage medium is displayed in the File List window.

#### • Floppy Disk

FD: Floppy disk

PC Card: PC card

NetWork: Network drive (when the Ethernet interface option is installed)

USB: USB storage

### Floppy Disk/PC Card/External USB Storage

The handling of the floppy disk, PC card, and external USB storage device are described in sections 12.2 and 12.3. For the formatting procedure, see section 12.4.

### File Name

Number of Characters	Characters That Can Be Used
1 to 14 characters	0 to 9, A to Z, %, _, (, )

### Auto Naming

When Auto Naming is turned ON, files with a four digit number from 0000 to 2399 (0000 to 1249 for binary format) are automatically created when saving the data. You can specify a common name (up to ten characters, specified through Filename) that is placed before the number.

### Reduced Image (Thumbnail) Data

If a screen image data file (a file with .TIF, .BMP, .PS, .PNG, or .JPG extension) is saved to the directory selected using File List on the IMAGE SAVE menu, data separate from the screen image data used for thumbnail display is created along with the screen image data itself. The extension of thumbnail data varies depending on the data format of the original screen image data as follows:

TIFF file: .TTD

BMP file: .BTD

PS file: .PTD

PNG file: .NTD

JPEG file: .JTD

The data size is approximately 2 to 6 KB for all five file types.

For information about the thumbnail display, see the next section.

### Note

- The maximum number of files that can be saved when auto naming is enabled is 2500.
  - If the total number of files and directories exceed 2500 in a single directory, the file list is no longer displayed.
-

## 12.10 Thumbnails of the Saved Screen Image Data can be Displayed



### CAUTION

Do not remove the storage medium (disk) or turn OFF the power when the access indicator or icon of the storage medium is blinking. Doing so can damage the storage medium or destroy the data on the medium.

### Procedure

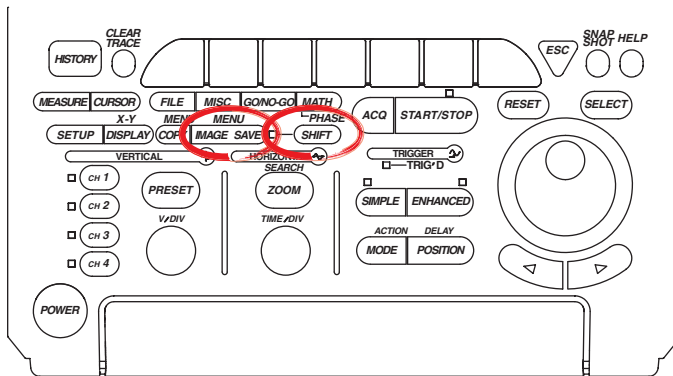

- To exit the menu during operation, press **ESC** located above the soft keys.
- In the procedural explanation below, the term **jog shuttle & SELECT** refers to the operation of selecting/setting items and entering values using the **jog shuttle** and **SELECT** and **RESET** keys. For details on this operation, see sections 4.1 and 4.2.
- For a description of the operation using a USB keyboard or a USB mouse, see section 4.3.

### Displaying Thumbnails from the IMAGE Menu

- Press **SHIFT+IMAGE SAVE (MENU)**. The IMAGE menu appears.
- Press the **Format** soft key. The Format menu appears.

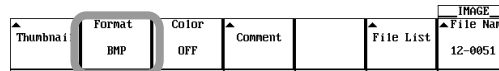

- Press the **TIFF, BMP, Post Script, PNG, or JPEG** soft key to select the data format of the screen image data whose thumbnail is to be displayed.

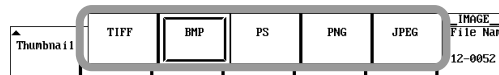

### Displaying the Thumbnails of the Specified Screen Image Data

- Press the **File List** soft key. The File List window appears.

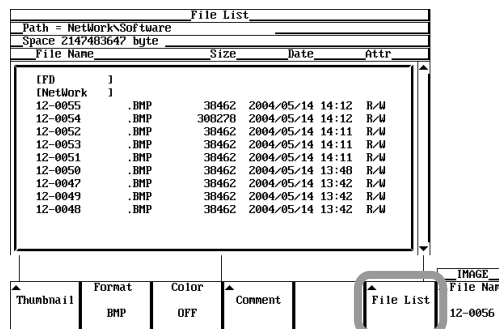

## 12.10 Thumbnails of the Saved Screen Image Data can be Displayed

- Use **jog shuttle & SELECT** to select the screen image data file in the File List window. The thumbnail of the selected screen image data file is displayed at the upper right section of the File List window.

To clear the thumbnail, turn the **jog shuttle**.

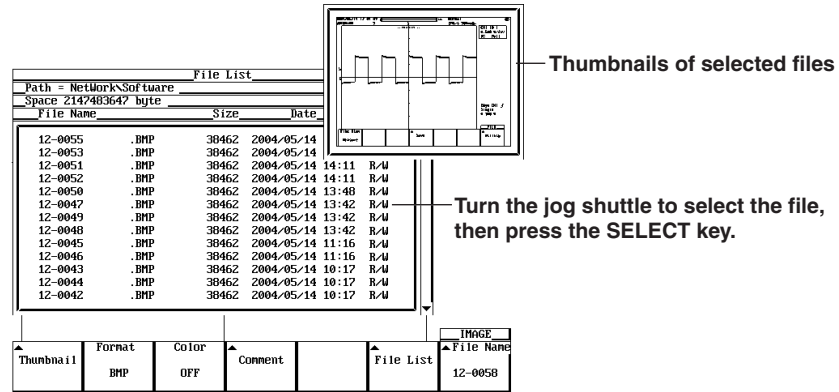

### Note

- If the selected screen image data file does not have data (file) for thumbnail display, an error message appears.
- You can press the ESC key to clear the thumbnail, but in this case, the File List window is also cleared. To clear only the thumbnail display, turn the jog shuttle.

### Listing the Thumbnails of Specified Data Format

- Press the **File List** soft key. The File List window appears.
- Use **jog shuttle & SELECT** to select the directory containing the thumbnails you wish to display.

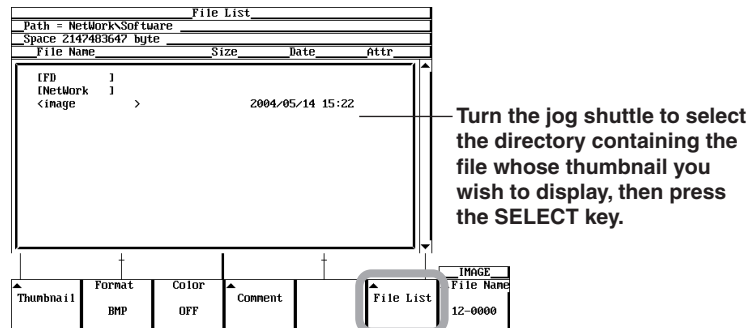

- Press **ESC** to close the File List window.
- Press the **Thumbnail** soft key. The thumbnails of the screen image data having the format specified in step 3 are displayed (4 thumbnails (2 × 2) in the waveform display area).

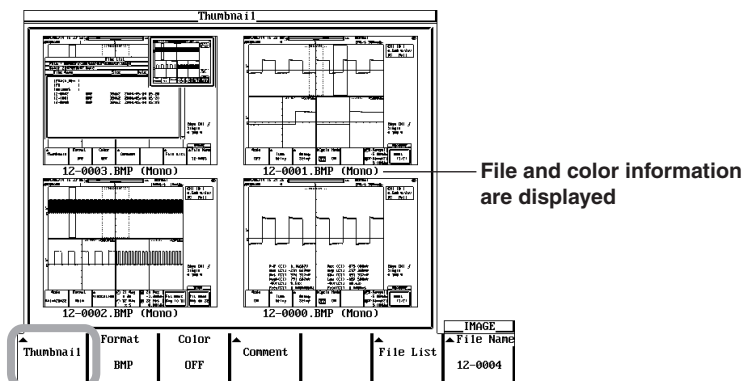

8. If there are more than five thumbnails, you can scroll the screen by turning the **jog shuttle**. To scroll the files upward, turn the jog shuttle counter-clockwise. To scroll the files downward, turn the jog shuttle clockwise. The files scroll two files at a time.
9. To clear the list of thumbnails, press **ESC**.

### Displaying Thumbnails from the FILE Menu

1. Press **FILE**. The FILE menu appears.
2. Press the **File Item** soft key. The File Item menu appears.

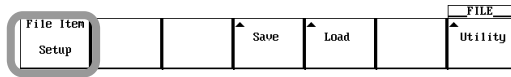

3. Press the **Image** soft key.

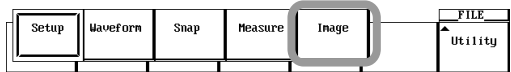

4. Press the **Format** soft key. The Format menu appears.



5. Press the **TIFF**, **BMP**, **Post Script**, **PNG**, or **JPEG** soft key to select the thumbnail format.

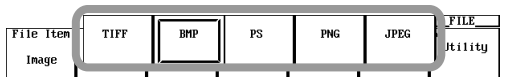

6. Press the **Utility** soft key. The Utility menu and the File List window appear.

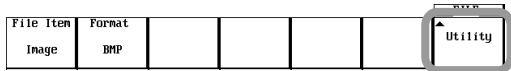

7. Press the **Function** soft key. The Function menu appears.

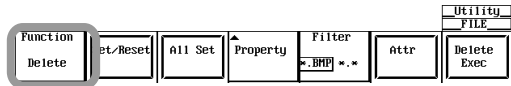

8. Press the **Delete**, **Copy**, **Rename**, or **Make Dir** soft key. Set Function to an item other than Format. If Function is set to Format, the screen image data files are not displayed.

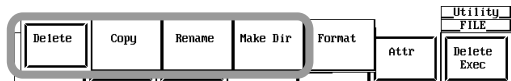

## 12.10 Thumbnails of the Saved Screen Image Data can be Displayed

- Use **jog shuttle & SELECT** to select the screen image data file (file with .TIF, .BMP, .PS, .PNG, or .JPG extensions) on the File List window. The thumbnail of the selected screen image data file is displayed at the upper right section of the File List window.  
To clear the thumbnail, turn the jog shuttle.

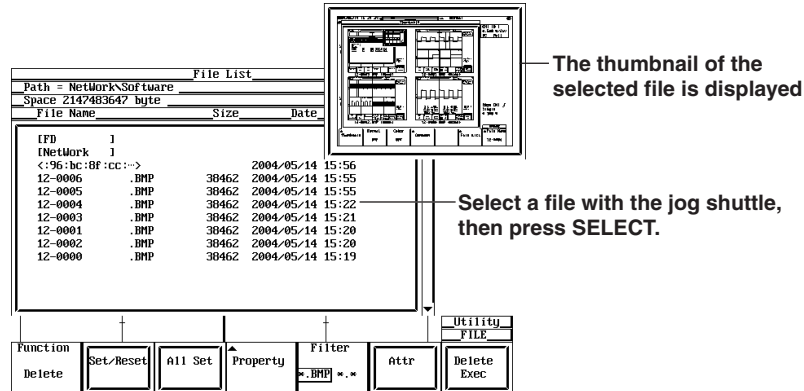

### Note

- If the selected screen image data file does not have data (file) for thumbnail display, an error message appears.
- You can press ESC to clear the thumbnail, but in this case, the File List window is also cleared. To clear only the thumbnail display, turn the jog shuttle.

### Explanation

Thumbnails of the screen image data that are saved on a storage medium can be displayed.

#### Thumbnail Display from the IMAGE Menu

##### • Thumbnail Screen

Thumbnails are displayed for the screen image data files (files with .TIF, .BMP, .PS, .PNG, and .JPG extensions) in the directory selected using File List in the IMAGE menu. The data used to display thumbnails is separate from the screen image data, but is created simultaneously when the screen image data is created. The extension of thumbnail data varies depending on the data format of the original screen image data as follows:

TIFF file: .TTD  
 BMP file: .BTD  
 PS file: .PTD  
 PNG file: .NTD  
 JPEG file: .JTD

The data size is approximately 2 to 6 KB for all formats.

##### • Thumbnail Items

The following three items are displayed.

- Thumbnail of the waveform area
- File name
- Color information
  - Mono: Color mode OFF (see page 12-35)
  - Color: Color mode ON
  - Reverse: Color mode ON (Reverse)
  - Gray: Color mode ON (Gray)



- **Thumbnail Display Format**

The number of files displayed on the thumbnail screen (the number of thumbnails displayed in the waveform area) is 4. The display order is the same as the order for displaying files in the File List window. In addition, the files are displayed from left to right and top to bottom.

- **Scrolling the Thumbnail Screen**

If the number of thumbnails exceeds the maximum number of thumbnails that can be displayed (4), the thumbnail screen can be scrolled one row (two thumbnails) at a time. To scroll the files upward, turn the jog shuttle counter-clockwise. To scroll the files downward, turn the jog shuttle clockwise.

- **Thumbnails on the File List**

When you select a screen image data file on the File List, the thumbnail of the screen image data is displayed at the upper right section of the File List. The file name is not displayed on the thumbnail screen on the File List.

### **Displaying Thumbnails from the FILE Menu**

When you select a screen image data file on the File List, the thumbnail of the screen image data is displayed at the upper right section of the File List. The file name is not displayed on the thumbnail screen on the File List.

### **Note**

---

The screen image data and thumbnail data are saved in pairs of files. For example, if you set the data format to BMP, the following two types of files are saved.

- 0000.BMP (screen image data)
- 0000.BTD (thumbnail data)

If you specify “...” for the files to be displayed (Filter) on the File List and manipulate individual files (Delete, Rename, or Copy), the thumbnail display function can no longer be used.

---

# 12.11 Changing the File Attributes and Deleting Files



## CAUTION

Do not remove the storage medium (disk) or turn OFF the power when the access indicator or icon of the storage medium is blinking. Doing so can damage the storage medium or destroy the data on the medium.

### Procedure

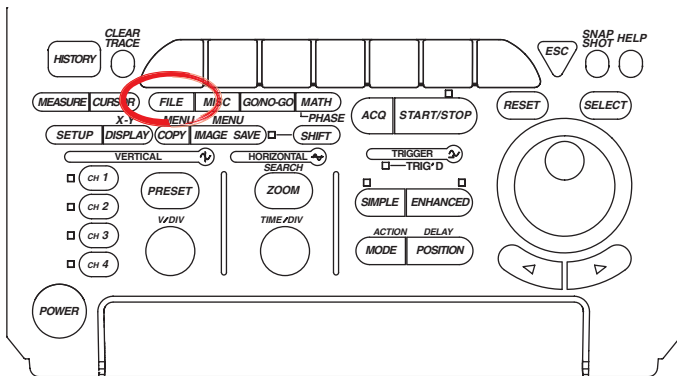

- To exit the menu during operation, press **ESC** located above the soft keys.
- In the procedural explanation below, the term **jog shuttle & SELECT** refers to the operation of selecting/setting items and entering values using the **jog shuttle** and **SELECT** and **RESET** keys. For details on this operation, see sections 4.1 and 4.2.
- For a description of the operation using a USB keyboard or a USB mouse, see section 4.3.

- Press **FILE**. The FILE menu appears.
- Press the **Utility** soft key. The Utility menu and the File List window appear.

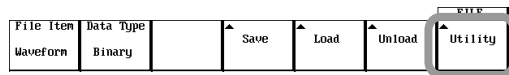

### Selecting the Medium and Directory

- The procedure is the same as steps 14 to 15 on page 12-14.

### Changing the File Attribute

- Turn the **jog shuttle** to select a file.
- Press the **Attr** soft key. The attribute of the selected file changes.  
To delete a file, change the file attribute to R/W (read/write)

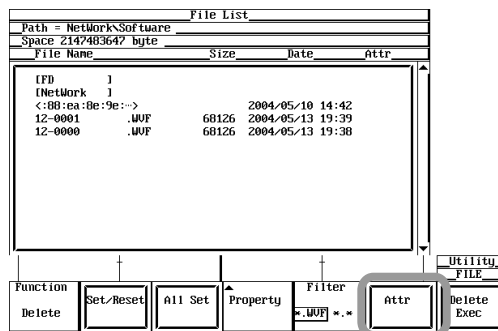

**Deleting Files**

6. Press the **Function** soft key. The Function menu appears.

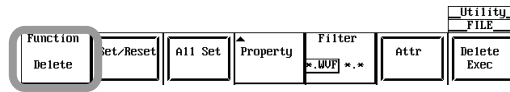

7. Press the **Delete** soft key.

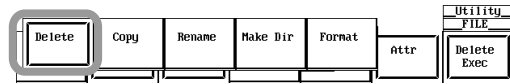

• **Selecting/Resetting the File to Be Deleted One at a Time**

- 8. Turn the **jog shuttle** to select a file.
- 9. Press the **Set/Reset** soft key. An asterisk (\*) is displayed to the left of the selected file to indicate that it will be deleted. Pressing the **Set/Reset** soft key again removes the asterisk (\*) to the left of the selected file.

Proceed to step 11.

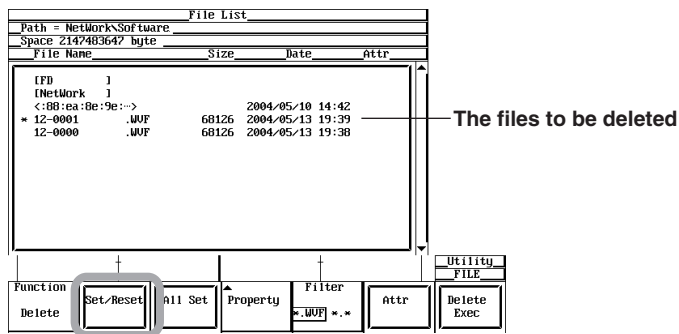

• **Selecting/Resetting the Files to Be Deleted at Once**

- 8. Turn the **jog shuttle** to select a file, directory, or medium.
- 9. Press the **All Set** soft key. Asterisks (\*) are displayed to the left of every file in the directory containing the selected file or directory to indicate that they will be deleted. At the same time, the All Set soft key changes to the All Reset soft key.

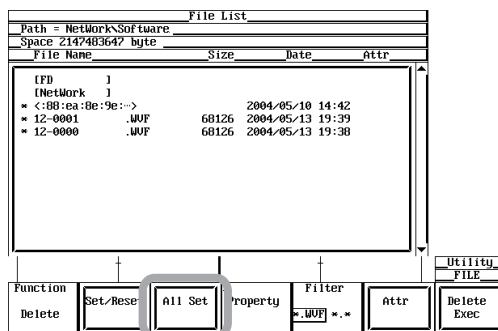

- 10. Press the **All Reset** soft key. Asterisks (\*) are removed from the left of every file in the directory containing the selected file or directory to indicate that they will not be deleted. At the same time, the All Reset soft key changes to the All Set soft key.

## 12.11 Changing the File Attributes and Deleting Files

---

### Executing the Deletion

11. Press the **Delete Exec** soft key. All files with asterisks (\*) are deleted.

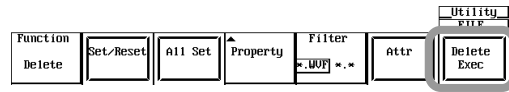

### Specifying the File and Properties to Be Displayed on the File List Window

9. The procedure is the same as steps 22 to 25 on page 12-15.

### Explanation

#### Selecting the Storage Medium and Directory

Media to and from which saving and loading are possible are displayed on the File List window.

- **Display Examples of Storage Media**

FD: Floppy disk

PC Card: PC card

NetWork: Network drive (when the Ethernet interface option is installed)

USB: USB storage

#### Selecting the File Attribute (Excluding Net Drive)

Select the file attribute of each file from the following.

- R/W: Read and write possible.
- R: Read only. Cannot write to the file or delete the file.

#### Selecting the Files to Be Deleted

You can delete all files that have an asterisk to the left of the file name. There are two methods in selecting the files to be deleted.

- **Selecting the files one at a time**

Press the Set/Reset soft key to place asterisks to the left of the files one at a time.

- **Selecting all files at once**

Places an asterisk to the left of all the file names using the All Set soft key.

Selecting a file or directory and pressing the All Set soft key places an asterisk on every file in the directory containing the selected file or directory.

#### Specifying the File to Be Displayed on the File List Window

Specify the type of files to be displayed.

- \*.Extension: Displays only the data file that was selected in the File Item setup menu and the data type menu.
- \*.\*: Displays all the files in the medium.

#### Properties

Displays information about the selected file including the name, extension, the file size, the date the file was saved, the attribute, and the comment.

### **Note**

- Files cannot be deleted while the waveform acquisition is in progress.
  - Data that are deleted cannot be recovered. Be sure you erase the correct files.
  - You can not delete directories if there are files in them.
  - If an error occurs while deleting multiple files, the files after the error occurrence are not deleted.
  - You cannot change a directory attribute.
  - This function cannot be used when using the FTP server function, FTP client function, the LPR client function, or the Web server function.
-

## 12.12 Copying Files



### CAUTION

Do not remove the storage medium (disk) or turn OFF the power when the access indicator or icon of the storage medium is blinking. Doing so can damage the storage medium or destroy the data on the medium.

### Procedure

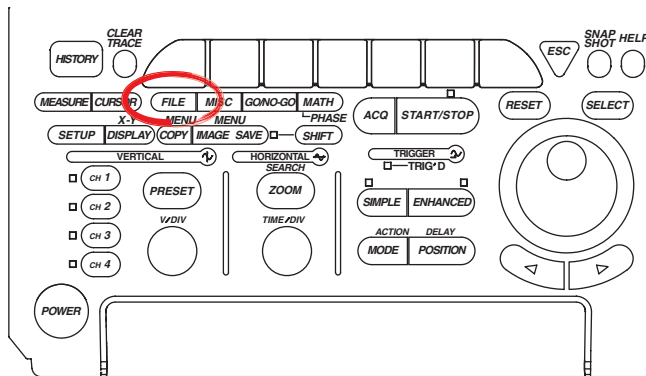

- To exit the menu during operation, press **ESC** located above the soft keys.
- In the procedural explanation below, the term **jog shuttle & SELECT** refers to the operation of selecting/setting items and entering values using the **jog shuttle** and **SELECT** and **RESET** keys. For details on this operation, see sections 4.1 and 4.2.
- For a description of the operation using a USB keyboard or a USB mouse, see section 4.3.

1. Press **FILE**. The FILE menu appears.
2. Press the **Utility** soft key. The Utility menu and the File List window appear.

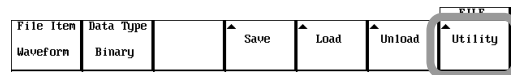

3. Press the **Function** soft key. The Function menu appears.

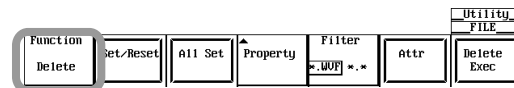

4. Press the **Copy** soft key.

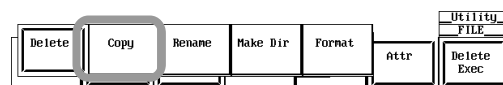

### Selecting the Copy Source

- **Selecting the Medium and Directory of the Copy Source**
5. The procedure is the same as steps 13 to 15 on page 12-14.

- **Selecting/Resetting the Copy Source Files One at a Time**

6. Turn the **jog shuttle** to select a file.
7. Press the **Set/Reset** soft key. An asterisk (\*) is displayed to the left of the selected file to indicate that it will be copied.

Pressing the **Set/Reset** soft key again removes the asterisk (\*) from the left of the selected file. The file will not be copied.

Proceed to step 11.

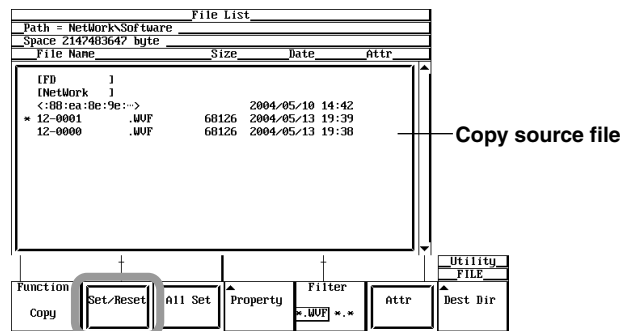

- **Selecting/Resetting the Copy Source Files at Once**

8. Turn the **jog shuttle** to select a file, directory, or medium.
9. Press the **All Set** soft key. Asterisks (\*) are displayed to the left of every file in the directory containing the selected file or directory to indicate that they will be copied. At the same time, the All Set soft key changes to the All Reset soft key.
10. Press the **All Reset** soft key. Asterisks (\*) are cleared from the left of every file in the directory containing the selected file or directory to indicate that they will not be copied. At the same time, the All Reset soft key changes to the All Set soft key.

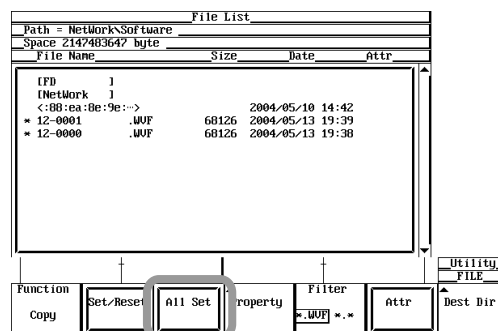

**Selecting the Copy Destination**

11. Press the **Dest Dir** soft key. The Copy menu and the copy destination File List window appears.

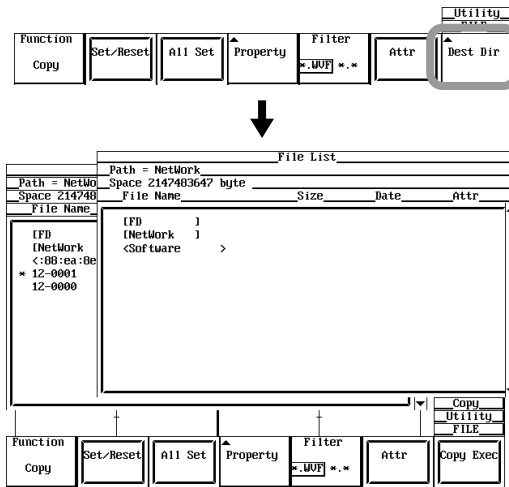

- **Selecting the Medium and Directory of the Copy Destination**

12. The procedure is the same as steps 13 to 15 on page 12-14.

- **Executing the Copy**

13. Press the **Copy Exec** soft key. All the copy source files with asterisks are copied.

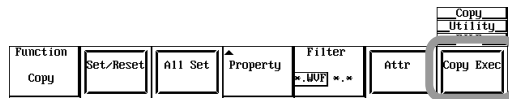

- **Specifying the File to Be Displayed in the File List Window and Viewing File Properties**

14. The procedure is the same as steps 22 to 25 on page 12-15.



**Explanation****Selecting the Copy Source Files**

You can copy all files that have an asterisk to the left of the file name. There are two ways to select the files to be copied.

- **Selecting the files one at a time**

Press the Set/Reset soft key to place asterisks to the left of the files one at a time.

- **Selecting all files at once**

Places an asterisk to the left of all the file names using the All Set soft key.

If you select a file and press the All Set soft key, asterisks are placed on all the files in the current directory.

- **Specifying the File to Be Displayed on the File List Window**

Specify the type of files to be displayed.

- **\*.extension:**

Displays only the data file that was selected in the File Item setup menu and the data type menu.

- **\*.\***

Displays all the files in the medium.

- **Properties**

Displays information about the selected file including the name, extension, the file size, the date the file was saved, the attribute, and the comment.

- **Reduce Image Display on the File List**

When you select a screen image data file on the File List, the reduced image of the screen image is displayed at the upper right section of the File List. Reduced images are displayed only for screen image data. Reduced images for waveform data and setup data are not displayed. In addition, reduce images do not display the file name and color information.

**Note**

- Files cannot be copied while the waveform acquisition is in progress.
- If an error occurs while copying multiple files, the files after the error occurrence are not copied.
- You cannot change a directory attribute.
- You cannot copy files if files with the same file name exist at the copy destination.
- You cannot copy the same files to another directory after copying the files. Select the files to be copied again and copy them.
- This function cannot be used when using the FTP server function, FTP client function, the LPR client function, or the Web server function.

## 12.13 Changing the Directory or File Name of the Storage Medium and Creating Directories



### Caution

Do not remove the storage medium (disk) or turn OFF the power when the access indicator or icon of the storage medium is blinking. Doing so can damage the storage medium or destroy the data on the medium.

### Procedure

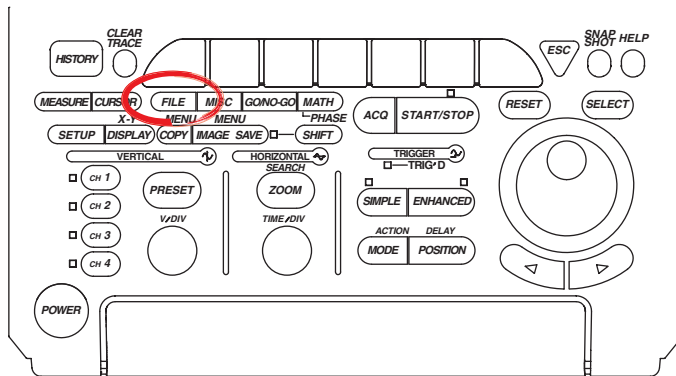

- To exit the menu during operation, press **ESC** located above the soft keys.
- In the procedural explanation below, the term **jog shuttle & SELECT** refers to the operation of selecting/setting items and entering values using the **jog shuttle** and **SELECT** and **RESET** keys. For details on this operation, see sections 4.1 and 4.2.
- For a description of the operation using a USB keyboard or a USB mouse, see section 4.3.

1. Press **FILE**. The FILE menu appears.
2. Press the **Utility** soft key. The Utility menu and the File List window appear.

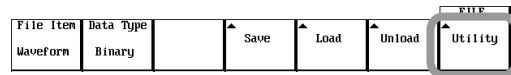

3. Press the **Function** soft key. The Function menu appears.



### Renaming a Directory or File

4. Press the **Rename** soft key.



### Selecting the Medium and Directory

5. The procedure is the same as steps 13 to 15 on page 12-14.

### Changing the File Attribute

6. The procedure is the same as steps 4 to 5 on page 12-42.

**Renaming a Storage Medium Directory or File (Excluding Net Drive)**

7. Turn the **jog shuttle** to select a directory name or file name.
8. Press the **File Name** soft key. A keyboard appears. The name of the selected directory or file is displayed in the entry box of the keyboard.

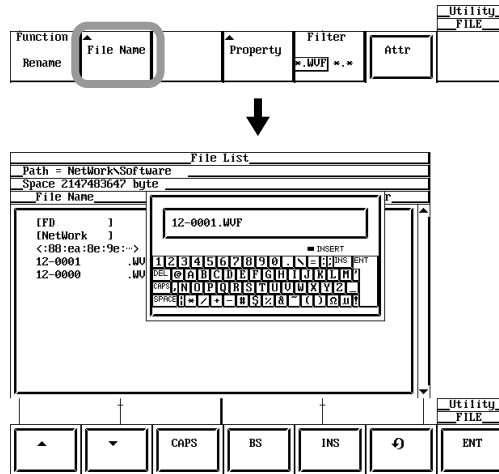

9. Record the directory and file name by following the procedure in section 4.2.

**Specifying the File and Properties to Be Displayed on the File List Window**

10. The procedure is the same as steps 22 to 25 on page 12-15.

**Creating a Directory**

Display the Function menu according to steps 1 to 3 on page 12-50.

4. Press the **Make Dir** soft key.

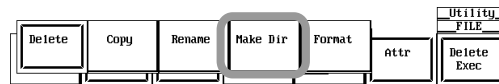

**Selecting the Medium and Directory**

5. The procedure is the same as steps 13 to 15 on page 12-14.

**Creating a Directory**

6. Press the **Dir Name** soft key. A keyboard appears.
7. Record the directory and file name by following the procedure in section 4.2.

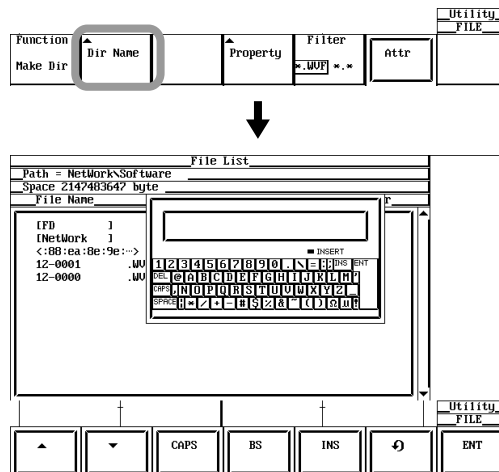

## 12.13 Changing the Directory or File Name of the Storage Medium and Creating Directories

---

### Specifying the File and Properties to Be Displayed on the File List Window

8. The procedure is the same as steps 22 to 25 on page 12-15.

### Explanation

#### Selecting the Storage Medium and Directory

Media to and from which saving and loading are possible are displayed on the File List window.

- **Display Examples of Storage Media**

FD: Floppy disk

PC Card: PC card

NetWork: Network drive (when the Ethernet interface option is installed)

USB: USB storage

#### Selecting the File Attribute

Select the file attribute of each file from the following.

- R/W: Read and write possible.
- R: Read only. Cannot write to the file or delete the file.

#### Renaming a Directory or File

- **Number and Types of Characters That Can Be Used**

Item	Number of Characters	Characters That Can Be Used
File name	1 to 14 characters	0 to 9, A to Z, %, _, ( , ), -

However, a directory name that starts with "FD" (ND000 for example) is not allowed.

#### Creating a Directory

You can create a new directory on the storage medium. See above for the assignment of the directory name when creating a new directory.

#### Specifying the File to Be Displayed on the File List Window

Specify the type of files to be displayed.

- **\*.extension:**  
Displays only the data file that was selected in the File Item setup menu and the data type menu.
- **\*.\***  
Displays all the files in the medium.

#### Properties

Displays information about the selected file including the name, extension, the file size, the date the file was saved, the attribute, and the comment.

#### Reduce Image Display on the File List

When you select a screen image data file on the File List, the reduced image of the screen image is displayed at the upper right section of the File List. Reduced images are displayed only for screen image data. Reduced images for waveform data and setup data are not displayed. In addition, reduced images do not display the file name and color information.

## 12.13 Changing the Directory or File Name of the Storage Medium and Creating Directories

---

### **Note**

- You cannot rename a directory/file or create a new directory while the waveform acquisition is in progress (START/STOP indicator is ON).
  - You cannot change a directory attribute.
  - If a file with the same name already exists in the same directory, the file cannot be renamed.
  - If a directory with the same name already exists in the same directory, the directory cannot be created.
  - This function cannot be used when using the FTP server function, FTP client function, the LPR client function, or the Web server function.
  - Files that do not have an archive attribute are not displayed in the File List window. Do not remove the archive attribute of the files saved by the instrument using your PC.
-

# 13.1 Connecting the Instrument to the Network

## Ethernet Interface Specifications

A 100BASE-TX port is provided on the rear panel of the instrument.

Item	Description
Number of communication ports	1
Electrical and mechanical specifications	Conforms to IEEE802.3
Transmission system	Ethernet (100BASE-TX/10BASE-T)
Transmission rate	100 Mbps max.
Communication protocol	TCP/IP
Supported services	FTP server, FTP client (network drive), LPR client (network printer), SMTP client (mail transmission), Web server, DHCP, DNS, SNTP, and WebDAV
Connector type	RJ-45 connector

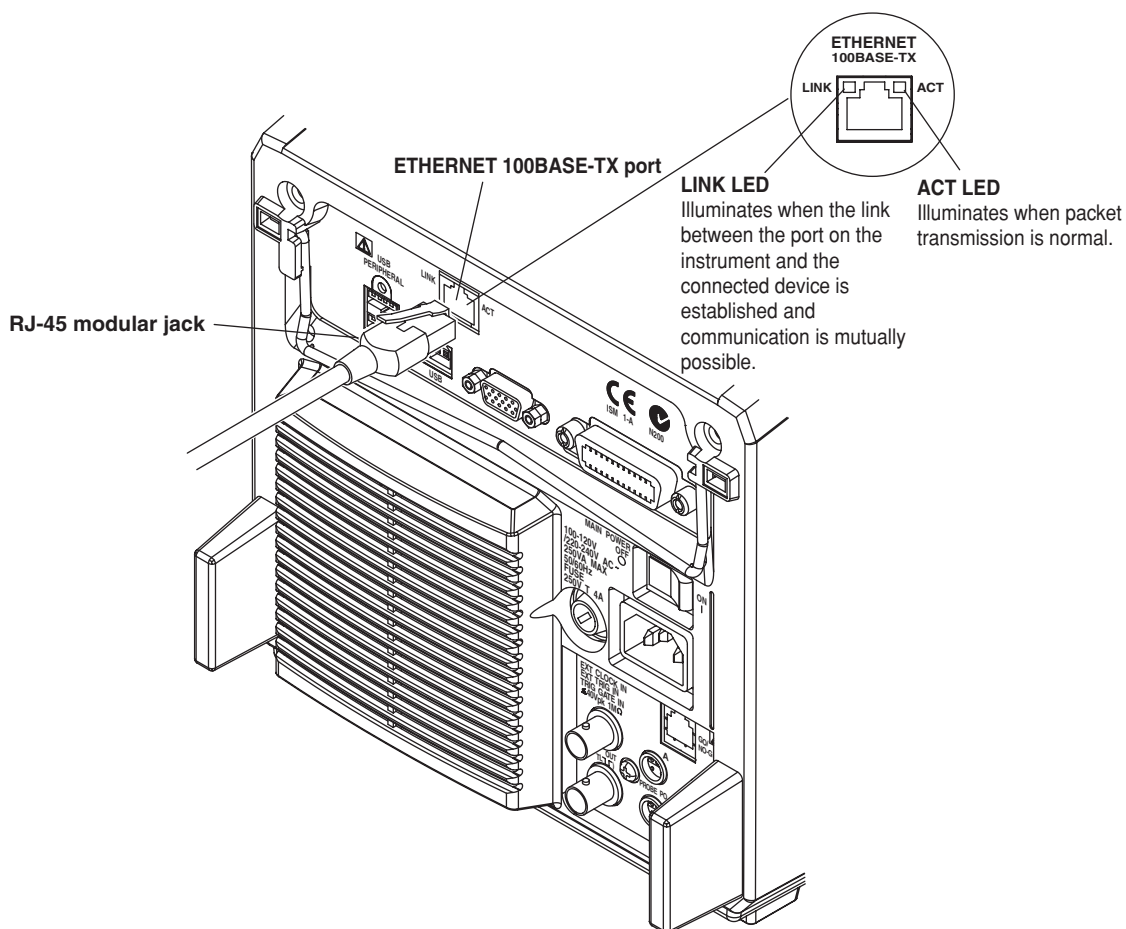

## Items Necessary for Connection

### Cable

Be sure to use one the following cables for connection.

- UTP (Unshielded Twisted-Pair) cable (category 5 or better)
- STP (Shielded Twisted-Pair) cable (category 5 or better)

### Connection Procedure

#### When Connecting to a Network PC or Workstation

1. Turn OFF the power switch and main power switch to the instrument (see section 3.3).
2. Connect one end of the UTP (or STP) cable to the ETHERNET 100BASE-TX terminal on the rear panel.
3. Connect the other end of the UTP (or STP) cable to a hub or router.
4. Turn ON the power switch and main power switch to the instrument (see section 3.3).

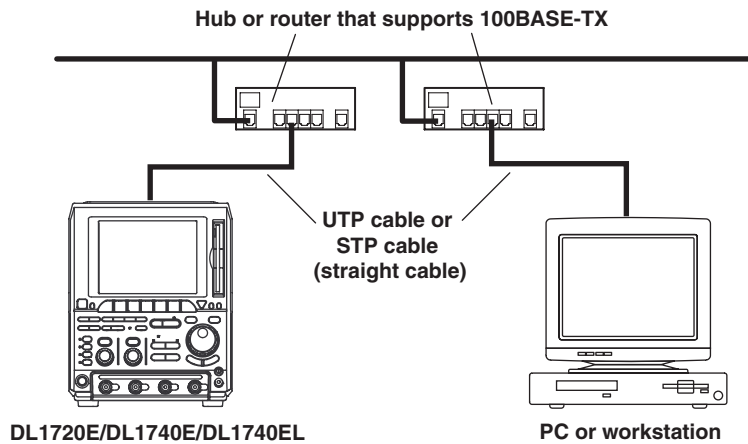

#### When Making a One-to-One Connection to the PC or Workstation

1. Turn OFF the power switch and main power switch to the instrument (see section 3.3), and turn OFF the PC or workstation.
2. Connect one end of the UTP (or STP) cable to the ETHERNET 100BASE-TX terminal on the rear panel.
3. Connect the other end of the UTP (or STP) cable to a hub or router.
4. Likewise, connect the PC or workstation to a hub or router.
5. Turn ON the power switch and main power switch to the instrument (see section 3.3).

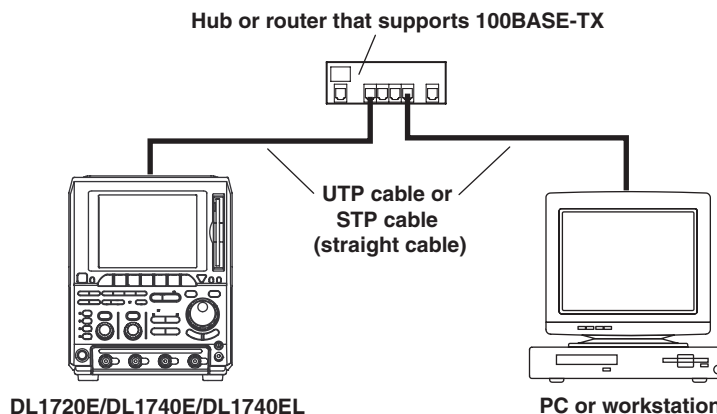

#### Note

- When connecting the PC or workstation one-to-one, a NIC (a 10BASE-T/100BASE-TX autoswitching card) is required for the PC or workstation.
- When using a UTP cable or STP cable (straight cable), be sure to use a category 5 or better cable.
- Avoid connecting the PC or workstation directly to the instrument without going through the hub or router. Operations are not guaranteed for communications using direct connection.

## 13.2 Setting Up the TCP/IP

### Procedure

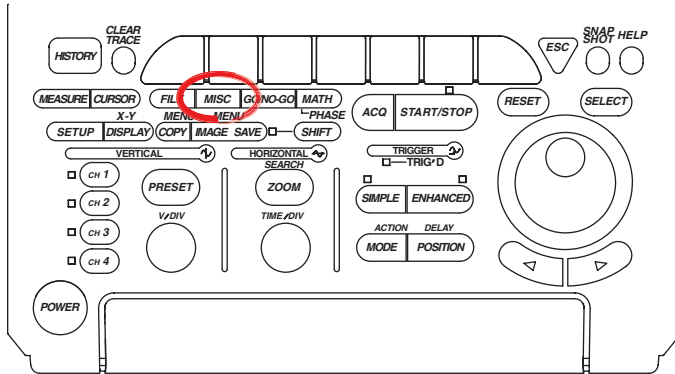

- To exit the menu during operation, press **ESC** located above the soft keys.
- In the procedural explanation below, the term **jog shuttle & SELECT** refers to the operation of selecting/setting items and entering values using the **jog shuttle** and **SELECT** and **RESET** keys. For details on this operation, see sections 4.1 and 4.2.
- For a description of the operation using a USB keyboard or a USB mouse, see section 4.3.

### Entering the TCP/IP Setup Menu

1. Press the **MISC** key. The MISC menu appears.
2. Press the **Network** soft key. The Network menu appears.



3. Press the **TCP/IP Setup** soft key. The TCP/IP Setup dialog box opens.

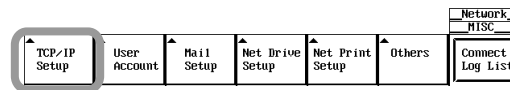

### Turning DHCP ON and OFF

4. Use **jog shuttle & SELECT** to set DHCP to ON or OFF.
  - If you select OFF, proceed to step 5.
  - If you set DHCP to ON, you do not have to set the IP address, subnet mask, default gateway below. If you select DNS, proceed to step 8. If DNS is not set, check the network cable connection and power-cycle the instrument. The IP address, subnet mask, and default gateway are automatically configured.

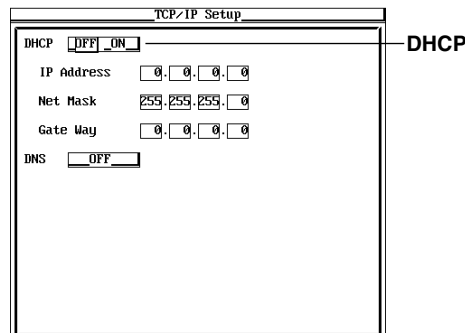



**Setting the IP Address**

If DHCP was set to OFF in step 4, set the IP address.

5. Use **jog shuttle & SELECT** to set the IP Address. Enter using values in the range of 0 to 255.

**Setting the Subnet Mask**

If DHCP was set to OFF in step 4, set the subnet mask.

6. Use **jog shuttle & SELECT** to set the Net Mask. Enter using values in the range of 0 to 255.

**Setting the Default Gateway**

If DHCP was set to OFF in step 4, set the default gateway.

7. Use **jog shuttle & SELECT** to set Gate Way. Enter using values in the range of 0 to 255.

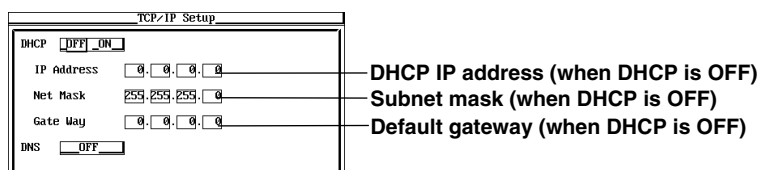

**Setting DNS**

8. Use **jog shuttle & SELECT** to set DNS to ON, OFF, or AUTO\*.
  - \* AUTO can be selected only when DHCP is ON.
  - When DNS is set to AUTO, the domain name and DNS server name are automatically configured by power-cycling the instrument.
  - If DNS is set to ON, set the domain name, DNS server name, and domain suffix.
  - If DNS is set to OFF, check the network cable connection and power-cycle the instrument.

**Setting the Domain Name**

If DNS was set to ON in step 8, set the domain name.

9. Use **jog shuttle & SELECT** to enter the domain name.

**Setting the DNS Server Address**

If DNS was set to ON in step 8, set the DNS server address.

10. Use **jog shuttle & SELECT** to set DNS Server1 (primary DNS server). Enter using values in the range of 0 to 255.
11. Likewise, set the secondary DNS server in DNS Server2.

**Setting the Domain Suffix**

If DNS was set to ON in step 8, set the domain suffix.

12. Use **jog shuttle & SELECT** to enter Domain Suffix1 (primary domain suffix).
13. Likewise, set the secondary domain suffix in Domain Suffix2.

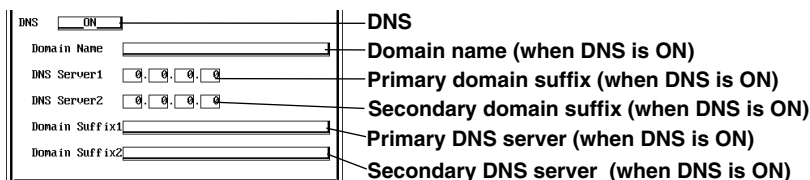

**Turning the Power Supply ON and OFF**

14. To apply the new settings, the instrument must be power cycled. After all the settings are complete, turn the power switch to the instrument OFF, then back ON again.

**Explanation**

The following TCP/IP settings must be entered to use the Ethernet communications functions on the instrument.

IP address  
Subnet mask  
Default gateway

**IP Address (Internet Protocol Address)**

You can assign an IP address to the instrument. The default setting is 0.0.0.0.

The IP address is an ID that is assigned to each device on an IP network such as the internet or an intranet. The address is a 32-bit value expressed using four octets (each 0 to 255), each separated by a period as in 192.168.111.24.

Obtain an IP address from your network administrator. The setting is automatically configured in environments using DHCP.

**Subnet Mask**

You can set the mask value used when determining the subnet network address from the IP address. The default setting is 255.255.255.0.

Huge TCP/IP networks such as the Internet are often divided up into smaller networks called sub networks. The subnet mask is a 32 bit value that specifies the number of bits of the IP address used to identify the network address. The portion other than the network address is the host address that identifies individual computers on the network. Consult your network administrator for the subnet mask value. You may not need to set the value. The setting is automatically configured in environments using DHCP.

**Default Gateway**

You can set the IP address of the gateway (default gateway) used to communicate with other networks. The default setting is 0.0.0.0.

The default gateway has control functions that handle protocol exchanges when communicating with multiple networks, so that data transmission is carried out smoothly. Consult your network administrator for the default gateway value. You may not need to set the value. The setting is automatically configured in environments using DHCP.

**DHCP (Dynamic Host Configuration Protocol)**

DCHP is a protocol that allocates setup information that is needed temporarily by PCs connecting to the network. When DHCP is turned ON, the following settings are automatically assigned.

IP address  
Subnet mask  
Default gateway  
DNS

To use DHCP, the network must have a DHCP server. Consult your network administrator to see if DHCP can be used.

When DHCP is turned ON, different settings may be assigned each time the power is turned ON. When using the FTP server function (see section 13.6), be sure to check the IP address and other settings of the instrument using a PC or workstation each time you turn ON the instrument.

### DNS (Domain Name System)

DNS is a system used to associate names used on the Internet called host names and domain names with IP addresses. Given AAA.BBBBB.com, AAA is the host name and BBBBB.com is the domain name. Instead of using the IP address, which is a sequence of numbers, the host name and domain name can be used to access the network.

On the instrument, you can specify the host by name instead of by IP address when using the FTP client function (see section 13.3) or the LPR client function (see sections 13.4).

You set the domain name, the DNS server address (0.0.0.0 by default), and the domain suffix. In networks that support DHCP, these settings can be configured automatically. For details, consult your network administrator.

### DNS Server

Up to two DNS server addresses can be specified (primary and secondary). If the primary DNS server is down, the secondary DNS server is automatically looked up for the mapping of the host name/domain name and IP address.

### Domain Suffix

When the IP address corresponding to the server name with the aforementioned domain name is not found, the system may be set up to search using a different domain name. Enter this alternate domain name as the domain suffix. Up to two domain suffixes can be specified, Domain Suffix1 (primary), and Domain Suffix2 (secondary).

### Note

---

- If you changed settings related to the Ethernet network, the instrument must be power cycled.
- If the instrument is turned ON with the DHCP function enabled without an Ethernet cable connected, communications and file functions may not operate properly. In this case, turn DHCP OFF and power cycle the instrument.

### Configuring the TCP/IP Settings of the PC

Communication parameters such as the IP address must be specified also on the PC side. Communication parameters are specified for each Ethernet NIC that is installed in the PC. Here, the settings of the NIC for connecting your PC and the instrument are explained.

If the IP address and other parameters are to be obtained dynamically using the DHCP server, the following settings are not necessary. In this case, select Obtain an IP address automatically under the IP Address tab of the TCP/IP Properties dialog box.

For example, if you are connecting a PC and the instrument to an independent Ethernet network, you can specify parameters as indicated in the next table. For details on the parameters, consult your system or network administrator.

Parameter	Value	Notes
IP address	Example: 192.168.21.128	IP address for the PC
Subnet mask	Example: 255.255.255.0	Set the same value as the subnet mask that was specified for the DL1720E/DL1740E/DL1740EL.
Gateway	None	
DNS	Disable	
WINS	Disable	

The following explains the settings under Windows 95/98/Me. For the NT, 2000 Pro, and XP versions of Windows, carry out equivalent steps accordingly.

- 1. Choose Settings > Control Panel from the Start menu to open the Control Panel folder.
- 2. Double-click the Network icon to display the network setup dialog box below.
- 3. Select the TCP/IP corresponding to the Ethernet NIC that is connected to the PC and click Properties to display the TCP/IP properties setup dialog box.

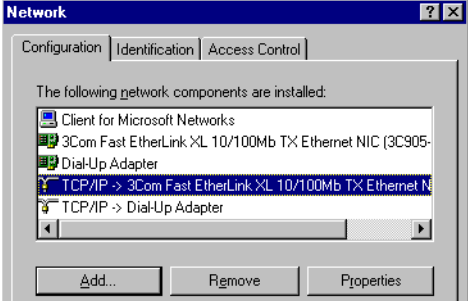

- 4. Set the parameters such as the IP address according to the table above and click OK.



# 13.3 Saving and Loading Waveform Data, Setup Data, and Image Data on a Network Drive (FTP Client Function)

## Procedure

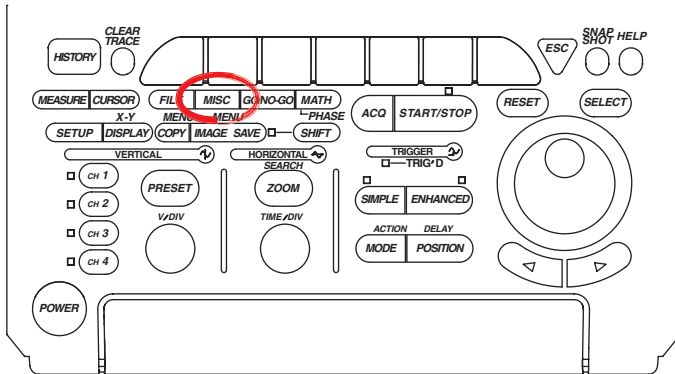

- To exit the menu during operation, press **ESC** located above the soft keys.
- In the procedural explanation below, the term **jog shuttle & SELECT** refers to the operation of selecting/setting items and entering values using the **jog shuttle** and **SELECT** and **RESET** keys. For details on this operation, see sections 4.1 and 4.2.
- For a description of the operation using a USB keyboard or a USB mouse, see section 4.3.

### Network Drive Settings

1. Press the **MISC**. The MISC menu appears.
2. Press the **Network** soft key. The Network menu appears.

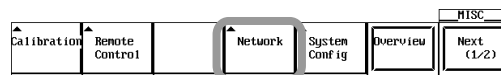

3. Press the **Net Drive Setup** soft key. The Net Drive Setup dialog box opens.



4. Use **jog shuttle & SELECT** to enter the FTP Server (IP address). If you are using DNS, you can specify the server by name.
5. Use **jog shuttle & SELECT** to enter the Login Name using up to fifteen characters.
6. Use **jog shuttle & SELECT** to enter the Password (corresponding to the Login Name) using up to 15 characters.  
If Login Name is set to "anonymous" in step 5, you do not have to enter the password.
7. Use **jog shuttle & SELECT** to set Time Out. The selectable range is 1 to 3600 (s).

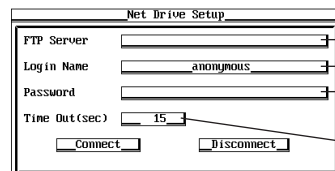

- Enter the IP address of the FTP server.
- Enter the login name using up to fifteen characters.
- You can enter the password corresponding to the login name using up to fifteen characters.
- Set the timeout time from 1 to 3600(s).

### 13.3 Saving and Loading Waveform Data, Setup Data, and Image Data on a Network Drive (FTP Client Function)

#### Connecting to and disconnecting from the Network

- Turn the **jog shuttle** to move the cursor to Connect and press **SELECT** to establish a connection. When the connection is established,  is displayed at the upper right corner of the screen.

Use the jog shuttle to move the cursor to disconnect, then press **SELECT** to close the connection. The  icon displayed at the upper right corner of the screen disappears.

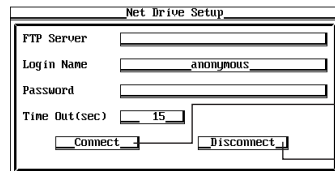

Select using the jog shuttle, the press **SELECT** to connect to the network drive.  
Select using the jog shuttle, the press **SELECT** to close the connection with the network drive.

#### Saving and Loading Waveform and Setup Data

- Press **FILE**. The FILE menu appears.
- Press the **Utility** soft key. The File List window appears.

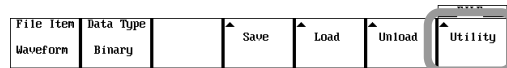

- Use **jog shuttle & SELECT** to select NetWork.

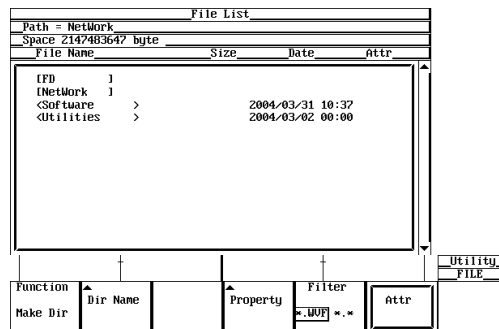

- Perform the save or load operation according to the procedures given in sections 12.5 to 12.8.

#### Saving Screen Images

- Press **SHIFT+IMAGE SAVE (MENU)**. The IMAGE menu appears.
- Press the **File List** soft key. The File List window appears.

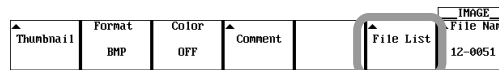

- Use **jog shuttle & SELECT** to select NetWork.

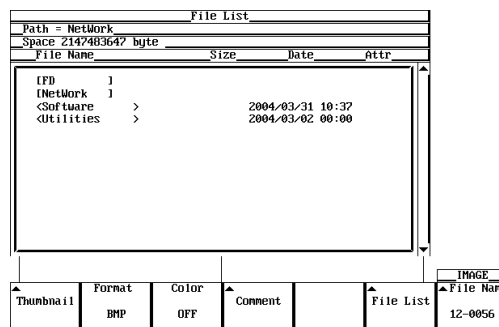

- Perform the save operation according to the procedures given in section 12.9.

### 13.3 Saving and Loading Waveform Data, Setup Data, and Image Data on a Network Drive (FTP Client Function)

---

#### **Note**

- An FTP server program must be running on the PC or workstation to which the instrument is to be connected. In addition, the following points need attention regarding the server program settings.
    - Set the list output (string returned by the dir command) to UNIX format.
    - Set the home directory and its subdirectories to allow writing.
    - The client cannot move above the home directory.
    - The newest file is not necessarily displayed at the top of the file list.
    - The length of file names and directory names that can be accessed varies depending on the server software.
    - Depending on the server, the symbol "<..>" that indicates a higher directory may not be displayed.
  - The time information in the file list will not be displayed correctly for the following cases.
    - On Windows NT when the time stamp is displayed using am and pm.
    - Servers that return characters other than ASCII characters in the list.
  - The following operations are not possible.
    - Turning file protect ON and OFF on saved files.
    - Formatting a network drive.
    - Copying between network drives.
    - Renaming a file on the network.
  - This function cannot be used when using the FTP server function or the Web server function.
  - To use this function, you must configure TCP/IP according to the procedure given in section 13.2.
  - To apply new settings that are made while connected to a network drive, drop the connection using disconnect and reconnect.
  - If you are disconnected by the server when using the FTP client, you will be automatically reconnected if you perform a file operation. This also holds true if the network drive is selected for Save to File when using an action trigger or GO/NO-GO.
  - When loading waveform data from a network drive, the loading may take time depending on the network conditions.

If there is enough free space on the storage medium, you can reduce the time by copying the waveform data from the network drive to the storage medium and loading the data from the storage medium.
- 

#### **Explanation**

As with the floppy disk drive and PC card drive, you can save or load waveform data or setup data or save screen image data to a network drive via the Ethernet network.

#### **Network Drives**

- **FTP Server**

You can enter the IP address of the FTP server (the PC or workstation running the FTP server) on the network to which waveform and setup data will be saved. On networks supporting DNS, you can specify the host and domain by name instead of the IP address.

- **Login Name**

You can enter the login name using up to fifteen characters. The default setting is "anonymous." The characters that can be used are all the ASCII characters on the keyboard.

- **Password**

You can enter the password corresponding to the login name using up to fifteen characters. The characters that can be used are all the ASCII characters on the keyboard.

- **Time Out**

When an FTP server is accessed from the instrument and data is not transmitted for a certain period of time (timeout time), the instrument decides that the transmission to the FTP server is not possible and closes the connection. You can set the value in the range of 1 to 3600. The default setting is 15 s.

# 13.4 Entering Settings for Printing Screen Images on the Network Printer (LPR Client Function)

## Procedure

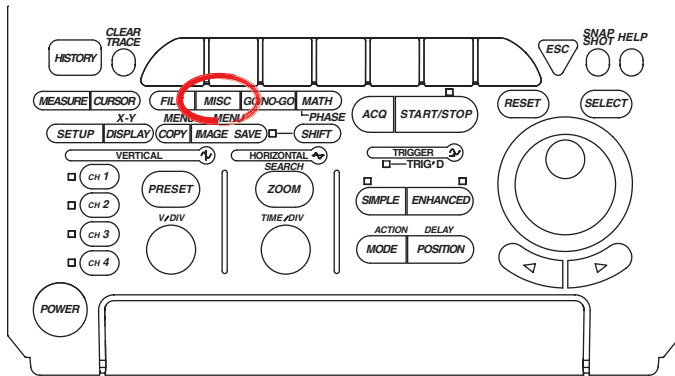

- To exit the menu during operation, press **ESC** located above the soft keys.
- In the procedural explanation below, the term **jog shuttle & SELECT** refers to the operation of selecting/setting items and entering values using the **jog shuttle** and **SELECT** and **RESET** keys. For details on this operation, see sections 4.1 and 4.2.
- For a description of the operation using a USB keyboard or a USB mouse, see section 4.3.

### Network Printer Settings

1. Press the **MISC**. The MISC menu appears.
2. Press the **Network** soft key. The Network menu appears.



3. Press the **Net Print Setup** soft key. The Net Print Setup dialog box opens.



3. Use **jog shuttle & SELECT** to enter the LPR Server (IP address of the printer server). If you are using DNS, you can specify the server by name.
4. Use **jog shuttle & SELECT** to enter the LPR Name (printer name).

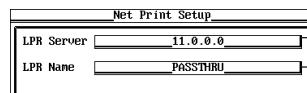

— Enter the IP address of the printer server.  
 — Enter the printer name.

### Printing Screen Images

5. Print screen images according to the procedures given in section 11.4.

### Note

- To use this function, you must configure TCP/IP according to the procedure given in section 13.2.
- Printing is possible on printers that support the TCP/IP protocol.
- This function cannot be used when using the FTP server function or Web server function or when performing file operations.



## 13.4 Entering Settings for Printing Screen Images on the Network Printer (LPR Client Function)

---

### ***Explanation***

As with the built-in printer (optional), you can print the screen image on a network printer via the Ethernet network.

#### **Network Printer**

- **LPR Server**

You can specify the IP address of the network printer server. On networks supporting DNS, you can specify the host and domain by name instead of the IP address.

- **Printer Name: LPR Name**

You can specify the name of the printer on which screen images will be printed.

# 13.5 Sending Periodic or Action Mail (SMTP Client Function)

## Procedure

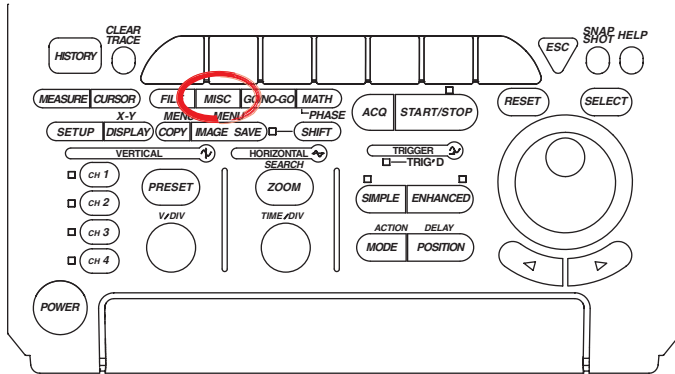

- To exit the menu during operation, press **ESC** located above the soft keys.
- In the procedural explanation below, the term **jog shuttle & SELECT** refers to the operation of selecting/setting items and entering values using the **jog shuttle** and **SELECT** and **RESET** keys. For details on this operation, see sections 4.1 and 4.2.
- For a description of the operation using a USB keyboard or a USB mouse, see section 4.3.

### Entering Mail Settings

1. Press the **MISC**. The MISC menu appears.
2. Press the **Network** soft key. The Network menu appears.



3. Press the **Mail Setup** soft key. The Mail Setup dialog box opens.



4. Use **jog shuttle & SELECT** to enter the Mail Server (IP address of the mail server). If you are using DNS, you can specify the server by name.
5. Use **jog shuttle & SELECT** to enter the Mail Address (recipient mail address) using up to forty characters.
6. As necessary, use **jog shuttle & SELECT** to enter a comment using up to thirty characters.
7. As necessary, turn the **jog shuttle** to set Attached Image File to ON (attach the image data) or OFF (not attach the image data).

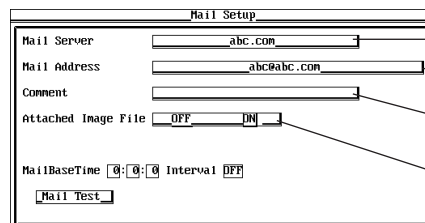

- Enter the IP address of the mail server.
- Enter the mail recipient using up to fifteen characters.
- Enter a comment using up to thirty characters.
- Turn image data attachments ON or OFF.

## 13.5 Sending Periodic or Action Mail (SMTP Client Function)

### Setting the Transmission Time of Periodic Mail

(For action mail, see "Setting Conditions for Sending Mail (Action Mail)" on the next page.)

8. Use **jog shuttle & SELECT** to enter the MailBaseTime (time when mail is to be sent).
9. Use **jog shuttle & SELECT** to set the Interval (interval for sending mail) in the range of 1h to 24h. If you are only using action mail, set this to OFF.

The screenshot shows a 'Mail Setup' window with the following fields: Mail Server (abc.com), Mail Address (abc@abc.com), Comment (empty), Attached Image File (OFF), MailBaseTime (0:0:0), Interval (OFF), and a Mail Test button.

Enter the time to send mail.  
You can set the interval for sending mail in the range of 1h to 24h.

### Sending a Test Mail

10. Turn the **jog shuttle** to move the cursor to Mail Test and press SELECT to send a test mail to the specified recipient.

The screenshot shows the same 'Mail Setup' window as above, but with the cursor positioned on the Mail Test button.

Sends mail to the specified mail recipient.

### Setting the Conditions for Sending Mail (Action Mail)

Perform steps 1 to 6 on the previous page.

A mail is sent when the following conditions are met.

- **When a Trigger Is Activated**  
For the setup procedure, see section 6.15.
- **Through GO/NO-GO Determination**  
For the setup procedure, see sections 10.9 and 10.10.

### Note

- The sender (From) address of the mail messages sent by the instrument is the same as the specified recipient address.
- If the transmitted contents indicate error logs, the most recent error is at the top of the error log.
- To use this function, you must configure TCP/IP according to the procedure given in section 13.2.
- If you set Interval to OFF, periodic mail is not sent.

**Explanation****Periodic Mail**

The instrument status can be sent periodically to a specified mail address on the network.

**Action Mail**

Information such as the trigger time can be sent to a specified mail address on the network as an action of GO/NO-GO determination or action-on-trigger.

**Mail**

- **Mail Server**

You can specify the IP address of the network mail server. On networks supporting DNS, you can specify the host and domain by name instead of the IP address.

- **Mail Address**

You can set the address of the mail recipient on the network using up to forty characters.

- **Comment**

The comment is written on the first line of the transmitted mail. Enter it as necessary. You can enter a comment using up to thirty characters.

- **Attaching Screen Image Data: Attached Image File**

The screen image shown at the time of mail transmission can be attached to the mail. The data format is fixed to PNG format. Color is ON (256 colors). For details on the data format, see section 12.9.

The file name is DL\_image.png. The file name used when attaching screen image data as an action of GO/NO-GO determination or action-on-trigger is DL\_nnnn.png (where nnnn is an automatically assigned number in the range of 0001 to 1000).

- **Transmission Time (for Periodic Mail Only): MailBaseTime**

The time when mail transmission is to start can be set in units of hours, minutes, and seconds.

Selectable range: 0:0:0-23:59:59

- **Transmission Interval (Periodic Mail Only)**

You can select the mail transmission interval.

- If you select OFF, periodic mails cannot be transmitted.
- If you are only using the action mail function, set this to OFF.

**Sending a Test Mail**

A test mail is sent to the address specified by Mail Address.

### DL1720E/DL1740E/DL1740EL Information That Is Transmitted

The following information is transmitted.

- **Periodic Mail**
  - Acquisition condition  
Start/Stop, trigger condition, and the acquisition counter
  - Error log information  
Error number and corrective action in English (up to sixteen errors)
  - Success/Fail information of GO/NO-GO  
Only when GO/NO-GO determination is executed (see section 10.9 or 10.10)
  - Results of waveform parameter measurement  
Results of automated measurement of waveform parameters (see section 10.6 or 10.8) or results of automated measurement parameters of when GO/NO-GO determination is executed using waveform parameters (see section 10.10).
- **Action Mail**
  - Acquisition condition  
Start/Stop, acquisition counter  
Trigger time
  - Success/Fail information of GO/NO-GO  
Only when GO/NO-GO determination is executed (see section 10.9 or 10.10)
  - Fail cause  
Only when GO/NO-GO determination is executed (see section 10.9 or 10.10)
  - Results of waveform parameter measurement  
Results of automated measurement of waveform parameters (see section 10.6 or 10.8) or results of automated measurement parameters of when GO/NO-GO determination is executed using waveform parameters (see section 10.10).

**Example of Transmitted Content**

• **Periodic Mail**

[Comment] aaaaaa

[ACQ Status] Stopped 162

[GO/NOGO Status] Success: 140 Fail: 21

Max (C1) 4.16667 V  
SDv (C2) 697.941 mV  
Freq(C3) 500.0000kHz  
+Wd (C4) 1.00us>

ErrNo 004 Completed GO/NO-GO.

ErrNo 806 GO/NO-GO is in execution. Please press the Abort key.

ErrNo 004 Completed GO/NO-GO.

ErrNo 806 GO/NO-GO is in execution. Please press the Abort key.  
Stop.

• **Action Mail**

[Comment] aaaaaa

[ACQ Status] Stopped 1

[Trigger Date and Time] 2004/05/17 17:28:59.38

[GO/NOGO Status] Success: 9 Fail: 1

[NOGO Factor] Param4(Ch4,tWd )

Max (C1) 4.16667 V  
SDv (C2) 697.941 mV  
Freq(C3) 500.0000kHz  
+Wd (C4) 1.00us>

# 13.6 Accessing the Instrument from a PC or Workstation (FTP Server Function)

## Procedure

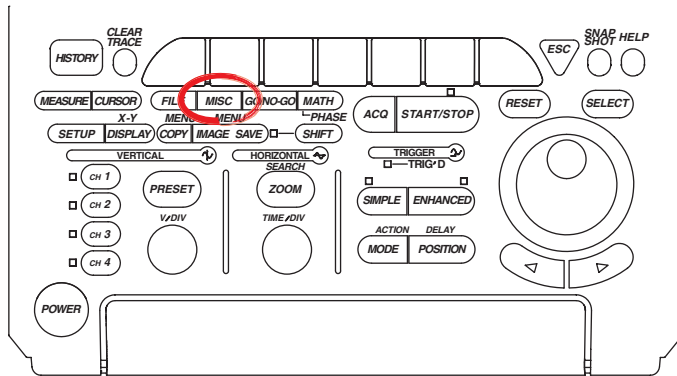

- To exit the menu during operation, press **ESC** located above the soft keys.
- In the procedural explanation below, the term **jog shuttle & SELECT** refers to the operation of selecting/setting items and entering values using the **jog shuttle** and **SELECT** and **RESET** keys. For details on this operation, see sections 4.1 and 4.2.
- For a description of the operation using a USB keyboard or a USB mouse, see section 4.3.

### User Account Settings

1. Press the **MISC**. The MISC menu appears.
2. Press the **Network** soft key. The Network menu appears.



3. Press the **User Account** soft key. The User Account dialog box opens.

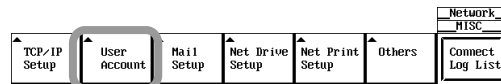

4. Use **jog shuttle & SELECT** to enter the User Name. Specify "anonymous" if you wish to allow access to all users. To restrict access, enter the user name using up to fifteen characters.
5. Use **jog shuttle & SELECT** to enter the Password using up to fifteen characters. Enter the password again for confirmation. If the user name is set to "anonymous", you do not have to enter the password.
6. Use **jog shuttle & SELECT** to enter the time out time (Time Out). The connection to the network is automatically closed if there is no access to the instrument for the specified time.

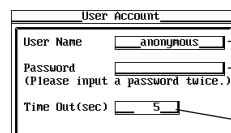

- Enter a user name using up to fifteen characters.
- Enter a password using up to fifteen characters. Reenter the password to confirm.
- Set the timeout time from 1 to 3600(s).

### Executing the FTP Client Software

7. Execute an FTP client on the PC or workstation. Perform file operations using the user name specified in step 4.

### Displaying the Log List

- Press the **Connect Log List** soft key. The data and time, user name, and IP address of the twenty-four recent accesses are displayed.

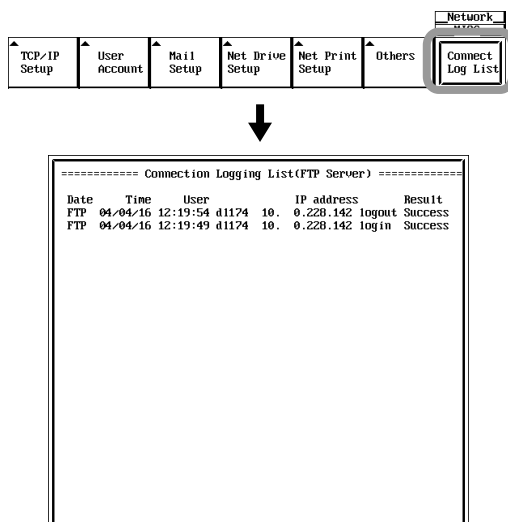

### Note

- The instrument supports two clients, but file operations cannot be performed simultaneously.
- When the instrument is accessed from the PC or workstation (login),  is displayed at the upper right corner of the screen.
- This function cannot be used when using the FTP client function, LPR client function, or Web server function or when performing file operations.
- The log list is cleared when the power is turned OFF.
- To use this function, you must configure TCP/IP in advance according to the procedure given in section 13.2.
- To activate the settings, you must power cycle the instrument.

### Explanation

The floppy disk drive or PC card on the instrument can be accessed from a PC or workstation on the network via the Ethernet network.

To access these drives, FTP client software is needed on the PC or workstation.

#### User Account

##### • User Name

You can enter the password using up to fifteen characters. The default setting is "anonymous." The characters that can be used are all the ASCII characters on the keyboard.

##### • Password

You can enter the password using up to fifteen characters. The characters that can be used are all the ASCII characters on the keyboard.

##### • Time Out

The connection to the network is automatically closed if there is no access to the instrument for the specified time. The default setting is 5 s. Set the timeout to a long value when using dedicated FTP client software.



---

## 13.7 Using the Web Server Function

You can use the Web server function on the instrument to display the screen image of the instrument on your PC's Web browser and perform file operations on the instrument using the keys displayed in the Web browser.

This section contains the following information.

- Overview of the Web server function -> See this page.
- Operating conditions
- PC environment -> See page 13-21.
- instrument environment -> See page 13-22.
- Preparations for using the Web server function
- Preparations on the instrument -> See page 13-23.
- Preparations on the PC -> See page 13-24.
- Using the web server function
- Using the FTP server function -> See 13-28.
- Performing data capture -> See page 13-29.
- Displaying the measurement trend of waveform parameters  
-> See page 13-35.
- Using control scripts -> See page 13-39.
- Showing the log -> See page 13-41.
- Showing the instrument information -> See page 13-43.
- Viewing the link destination -> See page 13-44.

### Overview of the Web Server Function

#### FTP Server Function (on a Web Browser)

View the list of files stored on the storage medium of the instrument (built-in storage medium) and transfer files to the PC.

#### Data Capture

The following operations can be performed.

- Change the display format of the instrument and display data that is acquired in the history memory.
- Display the screen image of the instrument.
- Save the waveform data and setup data to the PC.
- Load the setup data stored on the PC into the instrument.

#### Displaying the Measurement Trend of Waveform Parameters

Using the Excel function, display the trend of the selected waveform parameter values. The statistics of the measured values can also be computed.

#### Control Script

Control the instrument using communication commands (see the *Communication Interface User's Manual (IM701730-17E)*).

#### Log

Displays the past log of errors that occurred on the instrument, GO/NO-GO determination, and action-on-trigger. Up to the thirty newest incidents are logged.

#### Instrument Information

Displays the model of the instrument, the presence/absence of options, the ROM version (firmware version), etc.

**Link**

You can view the Web page for the instrument.

**Operating Conditions****PC Environment**

- **PC**

A machine capable of supporting the operating system and hardware described below.

- **OS**

Microsoft Windows 98 Second Edition, Microsoft Windows NT 4.0, Microsoft Windows Millennium Edition, Microsoft Windows 2000 Professional, or Microsoft Windows XP Professional.

- **Internal Memory**

64 MB or more recommended.

- **Communication Port**

Ethernet communication port that supports 10BASE-T or 100BASE-TX. Use this communication port to connect the PC to the network.

- **Display**

Display supported by the OS indicated above with a resolution of 1024 \_ 768 dots or higher.

- **Mouse or Pointing Device**

Mouse or pointing device supported by the OS indicated above.

- **Files Required for the Web Browser**

Of the Web server functions, the following files are required when using the data capture, measurement trend, or command script function. For the installation procedure on the PC, see "Installing Files Required for the Web Browser" (page 13-25).

msvbvm60.dll

cmdlgjp.dll

comdlg32.ocx

- **Combinations of OS and Application Software That Have Been Tested**

OS	Web Browser	Spreadsheet Software*
Windows NT	Internet Explorer 5.0	Microsoft Excel 97
Windows 98	Internet Explorer 5.0	Microsoft Excel 97
Windows 98 Second Edition	Internet Explorer 5.0	Microsoft Excel 97
Windows 2000 Professional	Internet Explorer 5.0/5.5/6.0	Microsoft Excel 97
Windows Millennium Edition	Internet Explorer 5.5/6.0	Microsoft Excel 97/2000/2002
Windows XP Professional	Internet Explorer 6.0	Microsoft Excel 2002

\* The spreadsheet software is required when displaying the trend of waveform parameters of the Web server function.

### Instrument Environment

- **Connection to the Network**  
Connect the instrument to the network using the Ethernet. For the Connection Procedure, see section 13.1.
- **TCP/IP**  
Configure the network environment and IP address for communication using the Ethernet interface. For the setup procedure, see section 13.2.
- **Communication Interface**  
Set the communication interface to Network. For the procedure, see “Setting the Communication Interface to the Network” (page 13-23).
- **User Account**  
Set the user account used to access the instrument from the PC. For the setup procedure, see section 13.6.
- **Time Difference from GMT (Greenwich Mean Time)**  
When using the Web Server function, set the time difference from the GMT. Normally, the time difference is also set on the PC. Setting the time difference correctly allows the instrument and the PC to detect the local time correctly. Consequently, the PC will be able to detect whether a file is new when transferring or saving the file. For the setup procedure, see section 13.8.

### Note

---

- Use Internet Explorer version 5.0 or later for the Web browser.
- The Web server function contains software programs that have not been authenticated. Therefore, the following dialog box may appear. If it does, click Yes and install the software.

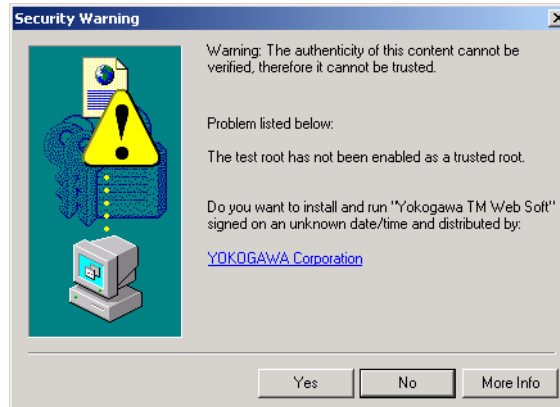

- You cannot open multiple Internet Explorer windows on the same PC and simultaneously use multiple identical features of the Web Server function.
  - When using the storage function of the FTP server function (on the Web browser), data capture function, or the log display on the same PC, other Web server functions cannot be used.
  - When using the storage function of the FTP server function (on the Web browser), data capture function, or the log display on a PC, other PCs cannot use the Web server function.
  - The Web server functions use the Ethernet interface for communication. If the Ethernet interface is configured for controlling the instrument using a communication command (see the Communication Interface User's Manual (IM701730-17E), the Ethernet interface cannot be used simultaneously.
  - The Web server function cannot be used while the DL1720E/DL1740E/DL1740EL is printing or operating files (file operation from the front panel key or file transfer using the FTP server function), or while the Windows network drive is being used.
-

## Preparations for Using the Web Server Function

### Connecting the PC and the instrument to the Network

Connect the PC and the instrument to the network. For the Connection Procedure, see section 13.1.

### Preparations on the Instrument

- **Setting the Communication Interface to Network**

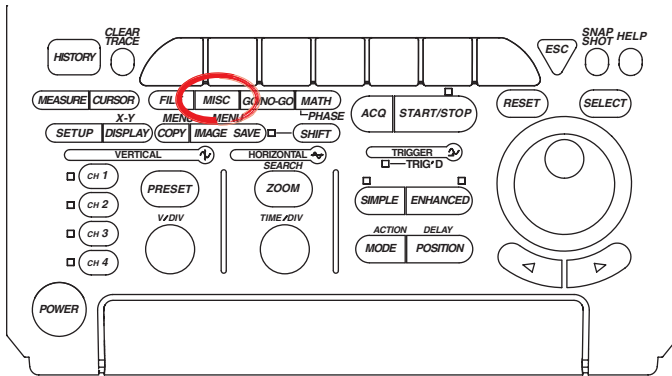

- To exit the menu during operation, press **ESC** located above the soft keys.
- For a description of the operation using a USB keyboard or a USB mouse, see section 4.3.

Turn ON the power to the instrument. After the instrument boots up normally, carry out the following procedure.

1. Press the **MISC**. The MISC menu appears.
2. Press the **Remote Control** soft key. The Remote Cntl menu appears.

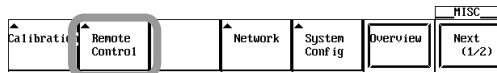

3. Press the **Device** soft key. The Device menu appears.

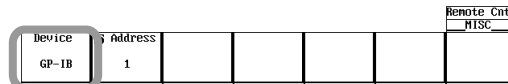

4. Press the **Network** soft key. The Ethernet interface is selected for the communication interface.

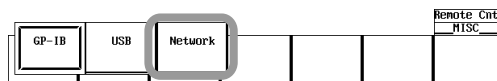

- **Setting Up the TCP/IP**

5. Set the TCP/IP on the PC and the instrument. For the procedure on the instrument, see section 13.2.

- **Creating a User Account for Accessing the instrument**

6. Set the user account used to access the instrument from the PC. For the setup procedure, see section 13.6.

### Note

The User Account in the menu that appears after step 4 is the user account that is used to control the instrument through communication commands via the Ethernet network. It is not the user account for using the Web server function.

## 13.7 Using the Web Server Function

- **Setting the Time Difference from GMT (Greenwich Mean Time)**

7. Set the time difference between the location where the instrument is installed and GMT. For the setup procedure, see section 13.8.

- **Rebooting**

8. To activate the TCP/IP, user account, and time difference settings, turn OFF the power switch. After a few seconds, turn ON the power switch to boot the instrument.

### Preparations on the PC

1. Power up the PC and log on.  
If the PC is running Windows NT, Windows 2000, or Windows XP, log on as an administrator. If you do not log on as an administrator, you may not be able to install files that are required for using the Web server function (see the next page).

- **Logging into the Web Server (Instrument)**

2. Start Internet Explorer.
3. Enter the IP address of the instrument (for example, 192.168.0.101) or the host name of the instrument (for example, dl700E\_1) if a DNS server is available on the network.

**Enter the IP address**

**http://192.168.0.101/**

**Enter the host name**

**http://dl1700e\_1/**

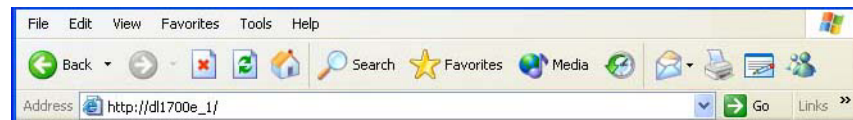

4. Press the **ENTER** key on the PC keyboard. A network password entry dialog box opens.
5. Enter the user name and password.
  - Enter the user account (see section 13.6) used to access the instrument. In the example below, DLUSER and \*\*\*\*\* (the password is not displayed) are entered for the user name and password, respectively.
  - If the user name of the user account is set to "anonymous" (default setting), the password is not required.
6. Click **OK**. If the login to the instrument Web server is successful, the Web server window appears.



## Web Server Window



- **Installing Files Required for the Web Browser**

**Using the instrument and the PC While Connected to the Internet**

When you use the Web server function for the first time, the files required for the Web browser are installed automatically from the Microsoft Web site.

\* If the three files (Msvbvm60.dll, cmdlgjp.dll, and comdlg32.ocx) are already installed in the PC when using the Web server function for the first time, step 7 is not required.

7. When the data capture, measurement trend, or command script function of the Web server function is used for the first time, three files, Msvbvm60.dll, cmdlgjp.dll, and comdlg32.ocx, are automatically downloaded from the Microsoft Web site and installed in the PC. At this point, a dialog box for confirming the installation appears. Click OK.

You may need to restart the PC during the installation.

After the installation completes successfully, proceed to step 9 on the next page.



OR



### Using the Instrument without Connecting to the Internet

If the three files, Msvbvm60.dll, cmdlgjp.dll, and comdlg32.ocx, are not installed in the PC when using the Web server function for the first time, install the files beforehand according to the following procedure.

7. Download the following file from the YOKOGAWA Web site (<http://www.yokogawa.com/tm/tm-softdownload.htm>).  
DL1700E series Web server function library installer  
YOKOGAWA T&M Web Runtime     ytmwrun.exe  
Size:                                     Approximately 1.5 MB
8. Double-click ytmwrun.exe after you have downloaded it. The installation of the aforementioned three files starts. Follow the on-screen instructions to complete installation of the files.

### Checking the Web Browser (Internet Explorer) Security Settings

Check the security settings on Internet Explorer. The settings indicated in the table on the next page are defaults. If the settings on your browser do not match, set them back to the settings in the table on the next page. Otherwise, the Web server function cannot be used.

The following explanation is for Internet Explorer 5.5. For other versions, carry out equivalent steps accordingly.

9. Choose Internet Options from the Tools menu. The Internet Options dialog box opens.
10. Click the Security tab.
11. Select a Web content zone.

The Web service zone varies depending on the network environment and browser settings. Check with your network administrator to select the zone.

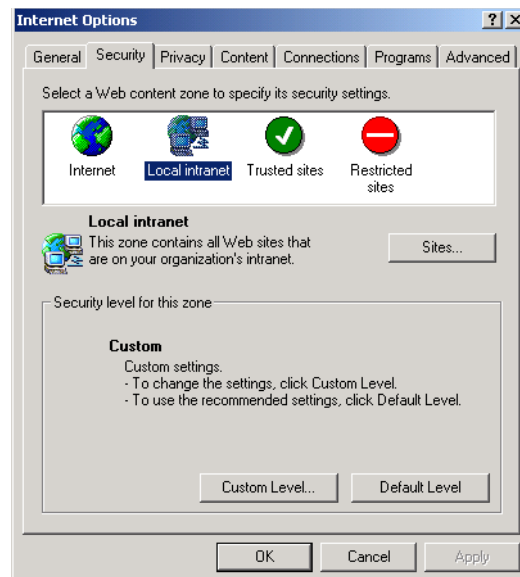

- Click Custom Level. The Security Settings dialog box opens.

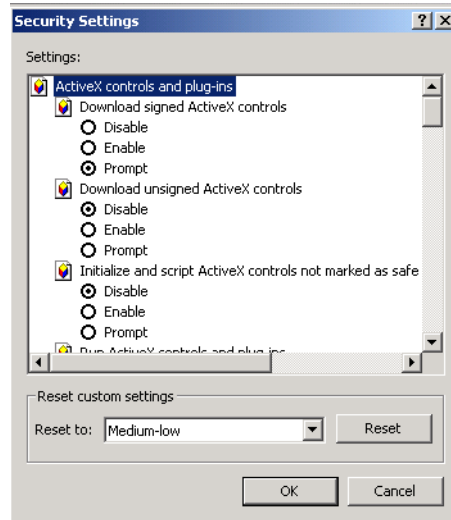

- Enter the security settings as shown in the following table.

Item	Security Level
Run ActiveX controls and plug-ins	Enable
Script ActiveX controls marked safe for scripting	Enable
Execute the control script	Display the dialog box
Download signed ActiveX controls	Display the dialog box

- Click **OK**.



**Using the Web Server Function**

**Using the FTP Server Function (on a Web Browser)**

Before using this function, check that the communication interface of the instrument is set to Network (see page 13-23).

Click the FTP icon on the Web server window. A window for viewing the storage media of the instrument (storage media view window) appears.

If the window does not appear, click the Refresh button on the Web browser. A login dialog box opens. Log in. The storage media view window appears.

**Web Server Window**



**Window for Viewing the Storage Media**

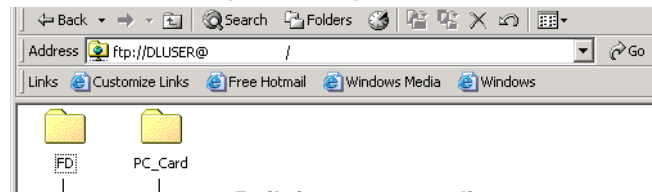

**Built-in storage media**  
 Depending on the product specifications, one of the following is displayed.

- FD: Floppy disk
- PC\_Card: PC card

- You can open folders on each storage medium and view the file list.
- You can select the files displayed in the window and transfer them to the PC.

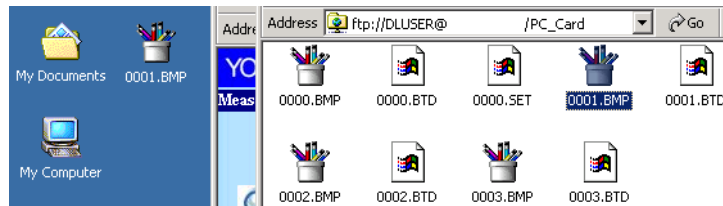

**Note**

- Up to two PCs can log into the file transfer function simultaneously.
- You cannot manipulate the files simultaneously from two PCs.
- When the instrument is printing or operating on files (file operation from the front panel key or file transfer using the FTP server function), the Web server function cannot be used.
- To use the FTP server on a Web browser, a network user account on the instrument must be configured. For the procedure of setting user accounts, see steps 1 to 6 in section 13.6.
- An authentication login dialog box may appear on the Web browser when the FTP icon on the Web server window is clicked. If it does, enter the user name and password that were entered in section 13.6.

### Performing Data Capture

Before using this function, check that the communication interface of the instrument is set to Network (see page 13-23).

Click the Data Capture icon on the Web server window. The Data Capture window showing the screen image of the instrument and the control panel that allows data saving and loading appears.

#### Web Server Window

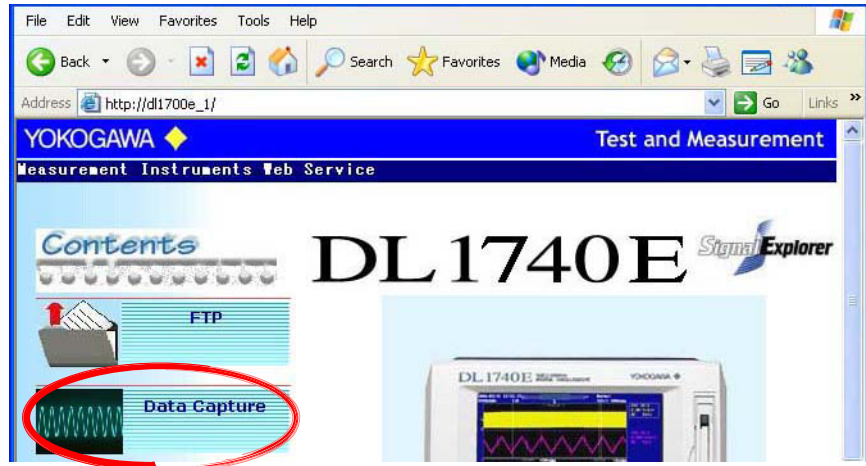

#### Dual Capture Window

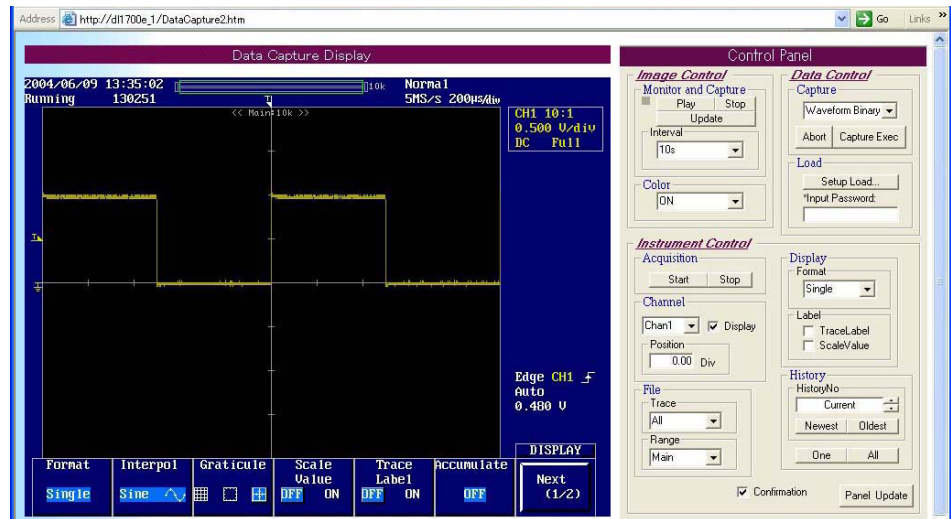

DL1720E/DL1740E/DL1740EL screen image

Control panel

### Displaying and Saving the Screen Image (Image Control)

The screen image of the instrument can be displayed on the PC screen and saved.

- **Updating the Screen Image (Monitor & Capture)**

**Play**

Click Play. The update indicator illuminates in green, and the updating of the screen image at the specified display update interval starts (see below).

**Stop**

Acquisition of waveform data stops. The update indicator turns off, and the updating of the screen image stops.

**Update**

Click Update. The screen image is updated.

**Interval**

Set the display update interval to 10 s, 30 s, or 60 s.

**Update indicator**

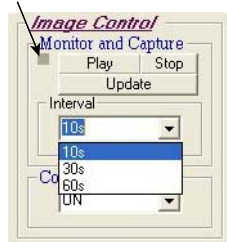

### Selecting the Display Color of the Screen Image (Color)

Select the display color from ON, OFF, Reverse, and Gray. For a description of the displayed information for each setting, see the explanation in section 12.9.

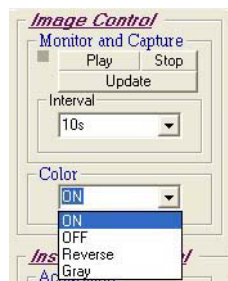

**Note**

---

The time it takes to display the screen image on the PC varies depending on the color setting. In decreasing order, the color settings are ON, Reverse, Gray, and OFF.

---

- **Saving Screen Images to a PC**

Right-click on the displayed screen image. The following shortcut menu appears. Choose Save Picture As to save the current screen image.

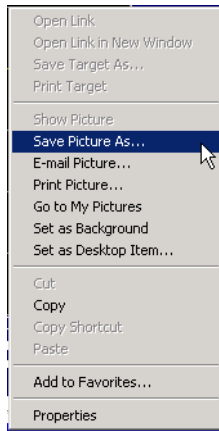

**Saving Data in the PC and Loading Setup Data from the PC into the instrument (Data Control)**

- **Saving Data in the PC (Capture)**

**Data Type**

Select the type of data to be saved from Waveform Binary, Waveform ASCII, Waveform Float, Setup, and Measure. For details on the settings, see the explanations in sections 12.5, 12.6, and 12.8.

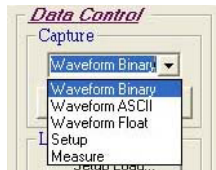

**Capture Exec**

Using the dialog box that appears when you click Capture Exec, set the save destination and file name and save the data.



**Abort**

To abort the save operation while data is being saved, click Cancel on the dialog box. Then, click Abort on the Control Panel.

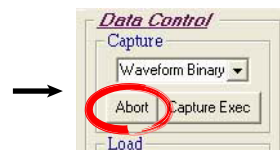
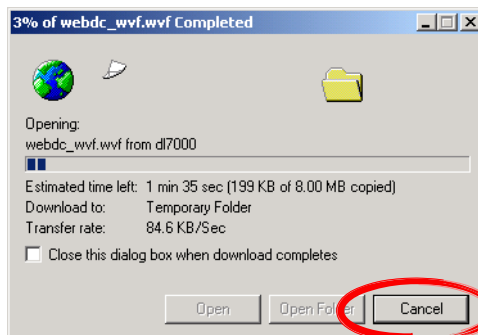

You must enter a password to abort. For details, see "Input Password" in the next section.

- **Loading the Setup Data from the PC into the Instrument (Load)**

**Input Password**

Enter the password (see page 13-24) that you used to log into the Web server (instrument). If the user name of the user account is set to “anonymous” (default setting), the password is not required.

**Setup Load**

Click Setup Load. The Open dialog box opens. Select the setup data file you wish to load and click OK to execute the load operation.

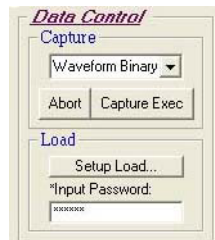

**Note**

---

- Depending on the operation condition of the instrument (such as when measurement is in progress), data save and setup data load operations may not be possible.
  - When data is being saved or the setup data is being loaded, other Web server functions cannot be used.
  - When loading the setup data or when aborting the save operation, a temporary file (zzzftpzzztmpzzz.bat) is created in the start directory of the Internet Explorer. After the operation is complete, the temporary file will be deleted.
  - If you execute the data save operation when there is no waveform data or waveform parameter, an error is displayed on the instrument screen, and a 0-byte file is saved.
- 

**Controlling the Instrument**

You can use the PC to set the display format and the data save conditions of the instrument. The settings entered here apply to the display format and save conditions used to save the data on the previous page.

- **Starting and Stopping Waveform Acquisition**

**Starting Acquisition**

Click Start. Waveform data acquisition starts.

**Stopping Acquisition**

Click Stop. Waveform data acquisition stops.

- **Turning Waveform Display ON and OFF, and Setting the Vertical Position (Channel)**

**Selecting the Target Waveform**

From the channel box, select the channel for turning ON/OFF the display and setting the vertical position.

Chan1 to Chan4 (channels 1 to 4)

\* Chan1 to Chan2 (channels 1 to 2) on the DL1720E.

**Display ON/OFF**

To display the waveform of the selected channel (turn it ON), select the Display check box. Clear the check box to not display the waveform of the selected channel (OFF).

**Vertical Position**

Set the vertical position of the waveform of the selected channel. For a description of the selectable range of the vertical position, see section 5.3.

- **Setting the Display Condition**

- **Display Format**

You can set the number of divided windows for displaying waveforms.

Single, Dual, Triad, Quad\*, Hexa\*

\* Quad and Hexa are not available on the DL1720E.

For the meanings of the selections, see the explanation in section 8.1.

- **Turning the Display of the Waveform Labels and Scale Values (Label) ON and OFF**

- **Display Waveform Label (TraceLabel)**

To display the labels of the displayed waveforms, select the TraceLabel check box.

Clear the check box to not display the labels.

Turning the Display of the Upper and Lower Limits of the Displayed Waveforms ON and OFF (ScaleValue)

To display the upper and lower limits of the displayed waveforms, select the ScaleValue check box. Clear the check box to not display the upper and lower limits.

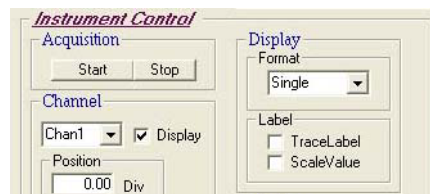

- **Selecting the Waveform to Be Saved (File)**

- **Selecting the Target Waveform (Trace)**

You can select the waveforms to be saved using the trace box.

All (all waveforms), 1 to 4 (channels 1 to 4)\*, Math1 to Math2 (computed waveforms)\*

\* All, 1 to 2 (channels 1 to 2), and Math1 on the DL1720E.

- **Selecting the Save Area (Range)**

Select the area in which the target waveform to be saved is displayed.

Main, Z1, Z2, or Z1\_Z2 (displayed as Z1&Z2 on the instrument menu)

\* For the meanings of the selections, see the explanation in section 12.5.

- **Setting the History Waveform Display**

- **Selecting by History Waveform Number (History No.)**

Specify the number of the history waveform to be displayed.

- **Selecting the Newest or Oldest Data**

You can specify the newest or the oldest waveform among the history waveforms to be displayed.

- **Selecting One or All**

- **One**

Click One. A single history waveform that is selected by the history waveform number or selected by newest or oldest is displayed.

- **All**

Click All. All the history waveforms are displayed.

- **Updating the Setup Condition (Panel Update)**

Click Panel Update. The control panel settings on the Data Capture window (PC) are updated to match the newest setup condition on the instrument.

## 13.7 Using the Web Server Function

---

- **Automatically Updating Screen Images (Confirmation)**

Select the Confirmation check box. The screen image is automatically updated using the same conditions as Color-OFF when you change the settings of the above items that would cause the screen image to change. Clear the check box to not update automatically.



### **Note**

---

- You cannot set the history waveform display when the instrument is making measurements.
  - Setting the history waveform display when there are no history waveforms results in error.
  - The time out time on the PC when controlling the instrument is thirty seconds. Depending on the condition of the instrument, the time out time may be reached causing control of the instrument to be terminated.
-

## Displaying the Measurement Trend of Waveform Parameters

Before using this function, check that the communication interface of the instrument is set to Network (see page 13-23).

Click the Measurement Trend icon on the Web server window. The Measurement Trend window in which the trend display of the waveform parameter values can be set appears.

### Web Server Window



### Measurement Trend Window

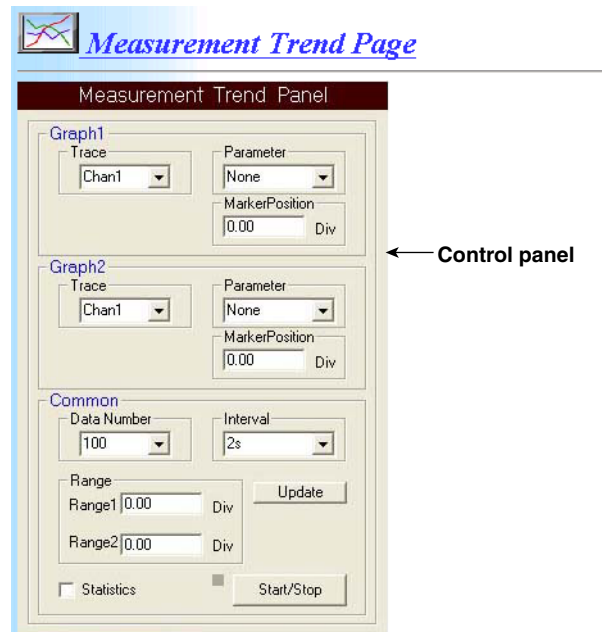

### Note

- This function retrieves the selected waveform parameter values at the selected retrieve interval from the instrument into the PC and displays the trend. To display the retrieved measurement values and trend, Microsoft Excel 97 or later must be installed on the PC.
- If the measured value of a waveform parameter is not a normal number (Not A Number), the cell displaying the measured value on Microsoft Excel is set to blank.
- This function cannot be used in roll mode.



**Setting the Trend Display Conditions**

- **Selecting the Waveform Parameter to Be Displayed (Graph 1 and Graph 2)**

You can display two trend graphs. For each graph, you can specify the trend target waveform and the waveform parameter. When the waveform parameter is Marker, you can set the Marker Position.

**Selecting the Target Waveform (Trace)**

You can select the waveforms to trend display in the Trend box.

Chan1 to Chan4 (channels 1 to 4)\*, Math1 to Math2 (computed waveforms)\*

\* Chan1 to Chan2 (channels 1 to 2), and Math1 on the DL1720E.

**Selecting the Waveform Parameter**

From the Parameter box, select the target waveform parameter of the trend display (same expression as the communication command). For the meanings of the waveform parameters and the marker cursor, see the explanation in section 10.5 or 10.6.

Parameter	Instrument display menu	Parameter display menu	Instrument
None	Not selected	NOVERSHOOT	-OShot
AVERAGE	Avg	NWIDTH	-Width
AVGFREQ	AvgFreq	PERIOD	Period
AVGPERIOD	AvgPriod	PNUMBER	Pulse
BWIDTH1	Burst1	POVERSHOOT	+OShot
BWIDTH2	Burst2	PTOPEAK	P-P
DELAY	Delay	-	-
(Detailed settings can be entered using Delay Setup on the instrument)			
DUTYCYCLE	Duty	PWIDTH	+Width
FALL	Fall	RISE	Rise
FREQUENCY	Freq	RMS	Rms
HIGH	High	SDEVIATION	Sdev
LOW	Low	TY1INTEG	Int1TY
MAXIMUM	Max	TY2INTEG	Int2TY
Marker(M1<2>)	M1<2>	XY1INTEG	Int1XY
(Cursor measurement marker cursors)			
MINIMUM	Min	XY2INTEG	Int2XY

**Setting the Marker Position**

Set the marker position if Marker(M1) or Marker(M2) is selected as the waveform parameter.

- **Setting the Conditions for Retrieving the Measured Values of Waveform Parameters (Common)**

- **Number of Displayed Measured Values (Data Number)**

- Select the number of measured values (measured values retrieved from the instrument into the PC) to be displayed in the cells of Excel from the following: 10, 20, 50, 100, 200, and 500. If the number of measured values exceeds the selected number, the values are cleared from the oldest values to display the newest measured values.

- 10, 20, 50, 100, 200, 500

- **Retrieve Interval**

- Select the retrieve interval from the following: 2 s, 5 s, 10 s, 30 s, and 60 s. However, of the selected waveform parameters, select the interval to match the longest parameter cycle measured on the instrument.

- 2s, 5s, 10s, 30s, 60s

- **Measurement Range**

- You can set the range on the time axis for measuring the waveform parameter.

- Range1 and Range2 are the start and end points, respectively.

- The selectable range is  $\pm 5$  divisions, and the resolution varies depending on the specified record length.

- However, the measurement start point cannot be set to the same point as the measurement end point or to a value to the right of the measurement end point.

- **Turning the Statistics Display ON and OFF**

- Displays the statistics (Max, Min, and Average) of the waveform parameters retrieved into the PC.
    - To display the statistics, select the Statistics check box. Clear the check box to not display the statistics.
    - The number of measurement values displayed in the cell of Excel is up to the number specified in "Number of Displayed Measured Values (Data Number)" on the previous page. The statistics are determined on all the measured data since the trend display was started, not on only the displayed measured values.

- **Updating the Setup Condition**

- Click Update. The Marker Position and Range that are set on the control Panel of the measurement trend window are updated to match the newest setup conditions of the instrument.

## 13.7 Using the Web Server Function

### Starting/Stopping the Trend Display of the Measured Values of the Waveform Parameters

- **Start**

Click Start/Stop. The indicator illuminates in yellow, and retrieval of the measured values of waveform parameters starts at the specified retrieve interval. At the same time, Microsoft Excel starts, and the measured values and trend graphs are displayed/drawn. If the statistical display is turned ON, the statistics are also displayed. The retrieval of the measured value of waveform parameter continues until the operation is stopped.

- **Stop**

- Click Start/Stop while the trend display is in progress. The indicator turns OFF, and the display and drawing of the measured values and trend graph stop.
- If you attempt to save the data to a file or close Excel while the trend display is in progress, a runtime error occurs. In this case, select No on the runtime error dialog box and close the dialog box. Then, click Start/Stop on the measurement trend window to stop the trend display. After stopping the trend display, save the file or close Excel.



### Display Example of Measured Values, Trend Graphs, and Statistics

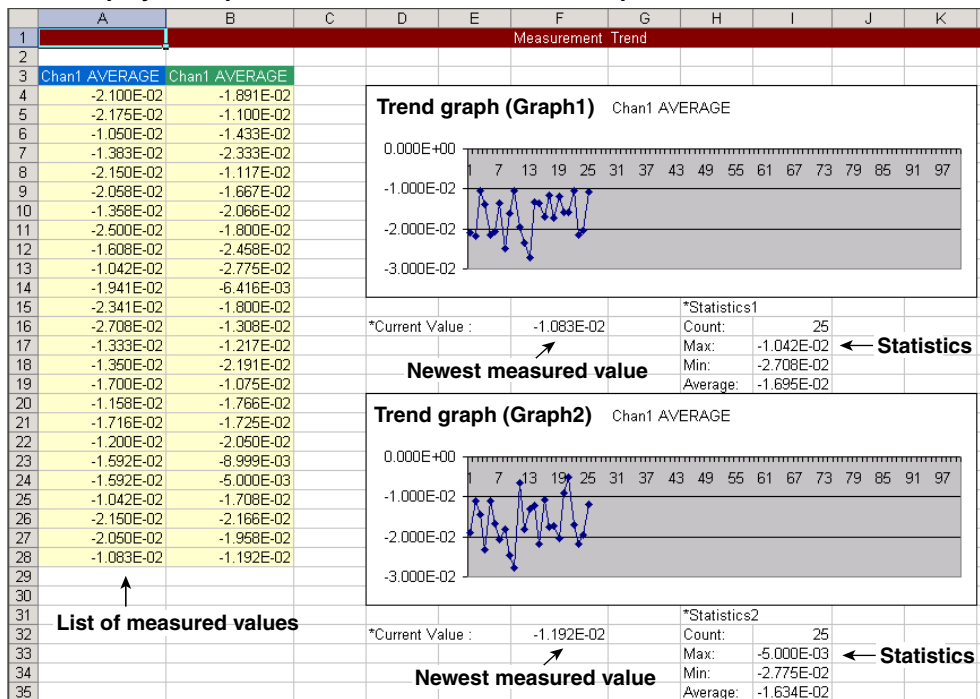

### Using Control Scripts

Before using this function, check that the communication interface of the instrument is set to Network (see page 13-23).

Click the Control Script icon on the Web server window. The Control Script window used to send communication commands (see the *Communication Interface User's Manual (IM701730-17E)*) to the instrument and display the responses from the instrument.

#### Web Server Window



#### Control Script Window

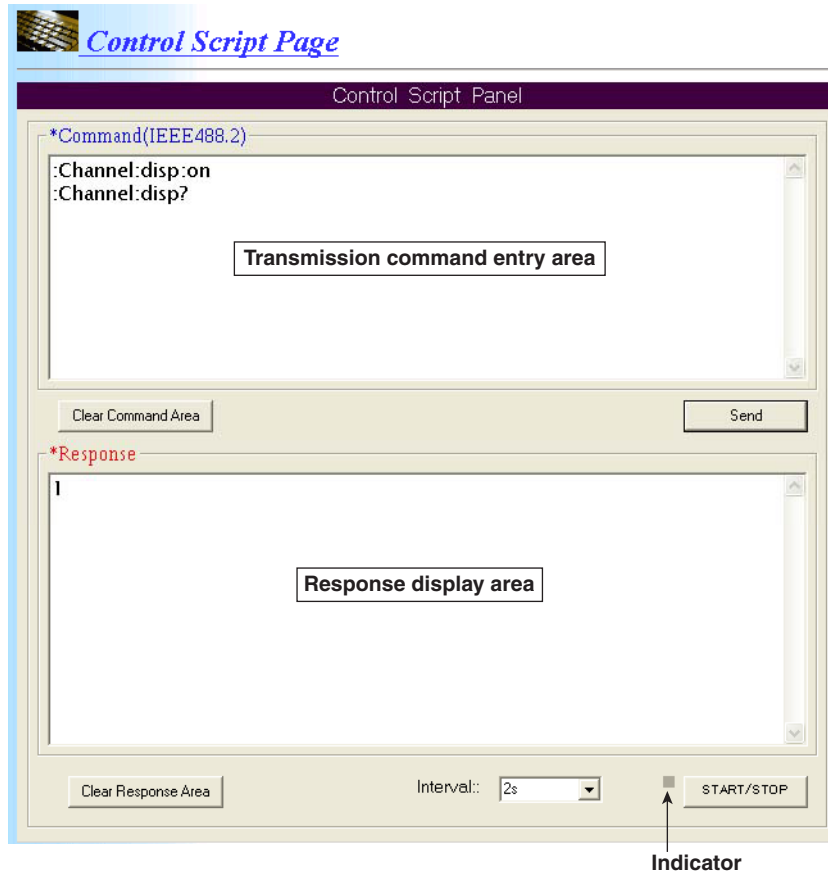

### **Sending Commands (\*Command IEEE 488.2)**

- **Entering Transmission Commands**

Enter the commands in the transmission command entry area.

The maximum number of input characters is 50,000 (50 KB).

- **Transmission Command (Send)**

Click Send. The commands in the transmission command entry area are sent collectively in the order displayed in the area.

- **Clearing the Entered Commands (Clear Command Area)**

Click Clear Command Area. All the commands in the transmission command entry area are cleared.

### **Displaying the Responses from the Instrument (\*Response)**

Receives and displays the responses from the instrument against the commands (queries) sent to the instrument using the control script function.

- **Clearing the Responses (Clear Response Area)**

Click Clear Response Area. All the responses received from the instrument that are displayed in the response display area are cleared.

### **Periodic Sending of Commands and Displaying of Responses**

Periodically sends the commands in the transmission command entry area. If commands (queries) that request responses from the instrument are sent, the responses from the instrument are displayed in the response display area.

- **Setting the Transmission Interval**

Select the command transmission interval.

2s, 5s, 10s, 30s, 60s

- **Starting Periodic Transmission (Start)**

Click Start/Stop. The indicator illuminates in yellow, and the command transmission and response display start at the specified transmission interval.

- **Stopping Periodic Transmissions (Stop)**

Click Start/Stop while the periodic transmission is in progress. The indicator turns OFF, and the command transmission and response reception/display stop. However, if the last command before stopping the periodic transmission was a query command, the response to that command is displayed in the response display area.

### **Note**

---

- If a wrong command is sent, the error message is not automatically displayed in the Control Script window. The error code and message are displayed by entering the “:status:error?” command in the transmission command input area. You can also confirm the error on the screen image displayed using the data capture function and also on the instrument screen.
  - Binary data cannot be received or displayed.
  - The time out time for transmissions is thirty seconds. If a transmission is sent or received for over thirty seconds, a time out error occurs. If all the commands specified in the transmission command entry area is sent, and the responses to the commands are not received within 30 s, a timeout error occurs.
-

## Displaying the Log

Before using this function, check that the communication interface of the instrument is set to Network (see page 13-23).

Click the Log icon on the Web server window. The Log window that can display the past log of errors that occurred on the instrument, GO/NO-GO determination, and action-on trigger appears. Up to the thirty newest incidents are logged. Logs older than the most recent thirty are not displayed.

### Web Server Window

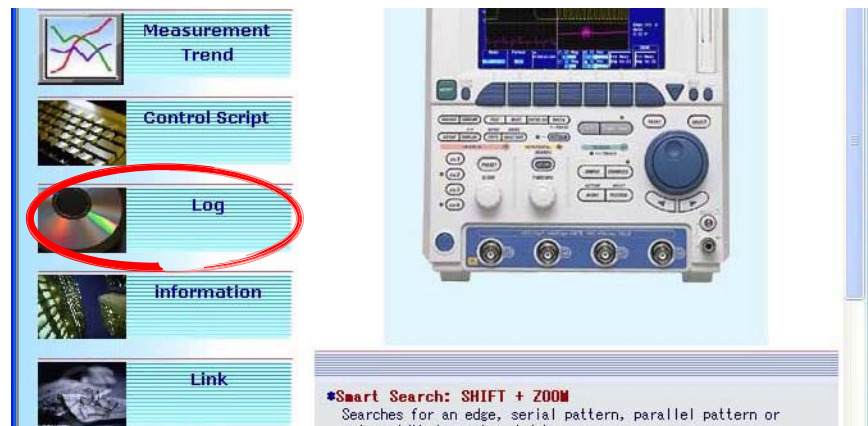

### Log Window

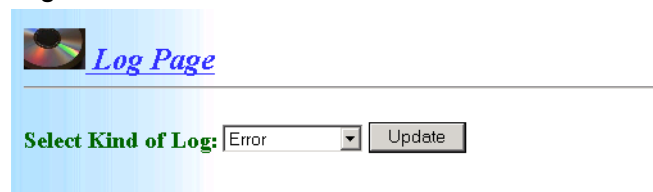

### Displaying the Log

- **Selecting the Log Type (Select Kind of Log)**

From the list box, select the item for displaying the log.

- Error (log of errors that occurred on the instrument)
- Go/Nogo (log of GO/NO-GO determination)

For the setup procedure for the GO/NO-GO determination, see sections 10.9 and 10.10.

- Action Trigger (log of action-on-triggers)

For the setup procedure for the action-on-trigger, see section 6.15.

- **Updating the Log (Update)**

Click Update. The selected log is displayed. If the selected type of log is the same as that of the log being displayed, the log is updated.

## 13.7 Using the Web Server Function

### Log Display Example

The following figure shows an example displaying the log of GO/NO-GO determination.

Displays "Executing..." while GO/NO-GO determination is in progress or when action-on-trigger is in execution.

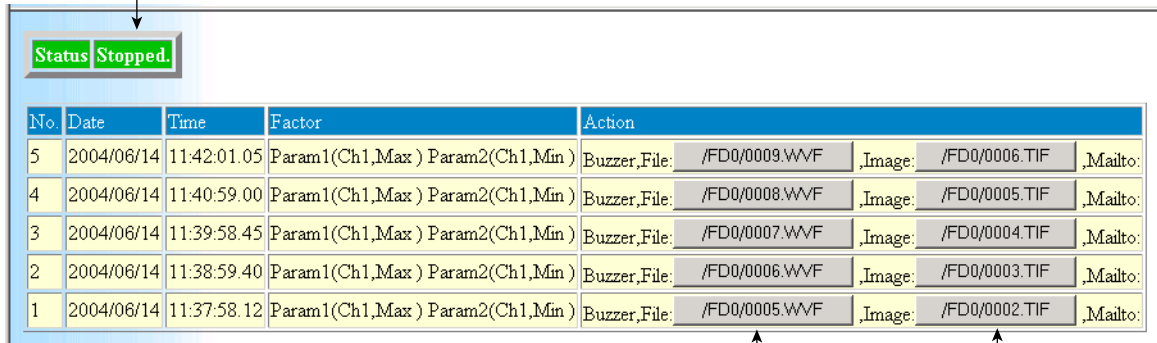

The screenshot shows a web interface with a status box at the top left containing the text "Status Stopped." Below it is a table with five columns: No., Date, Time, Factor, and Action. The table contains five rows of log entries. The Action column for each row lists files for Buzzer, Image, and Mailto. Arrows point from the text above to the status box and from the text below to the file paths in the Action column.

No.	Date	Time	Factor	Action
5	2004/06/14	11:42:01.05	Param1(Ch1,Max) Param2(Ch1,Min)	Buzzer_File: /FD0/0009.WVF ,Image: /FD0/0006.TIF ,Mailto:
4	2004/06/14	11:40:59.00	Param1(Ch1,Max) Param2(Ch1,Min)	Buzzer_File: /FD0/0008.WVF ,Image: /FD0/0005.TIF ,Mailto:
3	2004/06/14	11:39:58.45	Param1(Ch1,Max) Param2(Ch1,Min)	Buzzer_File: /FD0/0007.WVF ,Image: /FD0/0004.TIF ,Mailto:
2	2004/06/14	11:38:59.40	Param1(Ch1,Max) Param2(Ch1,Min)	Buzzer_File: /FD0/0006.WVF ,Image: /FD0/0003.TIF ,Mailto:
1	2004/06/14	11:37:58.12	Param1(Ch1,Max) Param2(Ch1,Min)	Buzzer_File: /FD0/0005.WVF ,Image: /FD0/0002.TIF ,Mailto:

If screen image data or waveform data files are being saved in the GO/NO-GO determination or action-on-trigger, the files can be saved on the PC from the Log display window.

The drive is indicated in the log as follows.

CA0: PC Card  
FD0: Floppy disk  
ND0: Network drive (when the Ethernet interface option is installed)  
US -: USB storage  
    └── Partition number (or LUN (Logical Unit Number))  
    └── Address number

#### Note

- When the instrument is printing or operating files (file operation from the front panel key or file transfer using the FTP server function), files cannot be saved on the PC. In addition, other Web server functions cannot be used while saving files.
- Files on the network drive (NetWork) cannot be saved to the PC.

### Displaying Instrument Information

Before using this function, check that the communication interface of the instrument is set to Network (see page 13-23).

Click the Information icon on the Web server window. The Information window that displays the instrument model (Model), the maximum record length available (Record Length), the storage media type (Media), the presence of options (Option), ROM version (firmware version, software version, and product ID), and other information appears.

#### Web Server Window



#### Information Window

**Information Page**

System Overview

Item	Contents
<i>Model</i>	701730
<i>RecordLength</i>	Max:2MW(1MW/CH)
<i>Media</i>	FDD(-J1),
<i>Option</i>	Printer:Yes Others:No
<i>Soft Version</i>	1.00
<i>Product ID</i>	



## 13.7 Using the Web Server Function

### Viewing the Link

Before using this function, check that the communication interface of the instrument is set to Network (see page 13-23).

Click the Link icon on the Web server window. You can view the Web page for the instrument.

#### Web Server Window

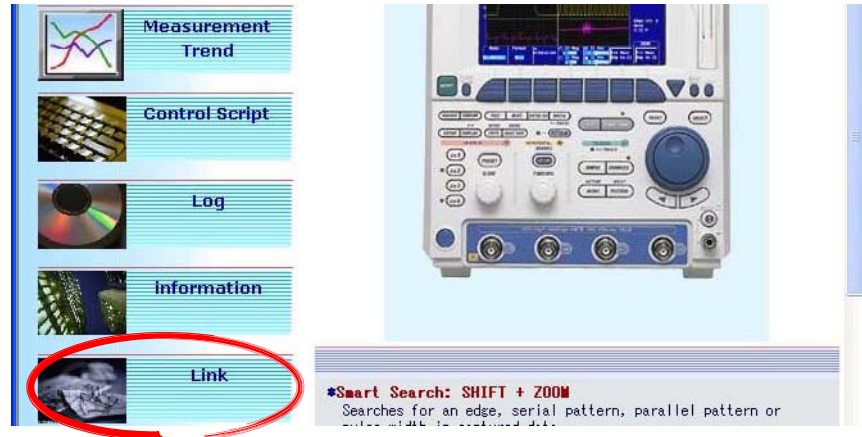

#### Web Page Example (English Web Page)

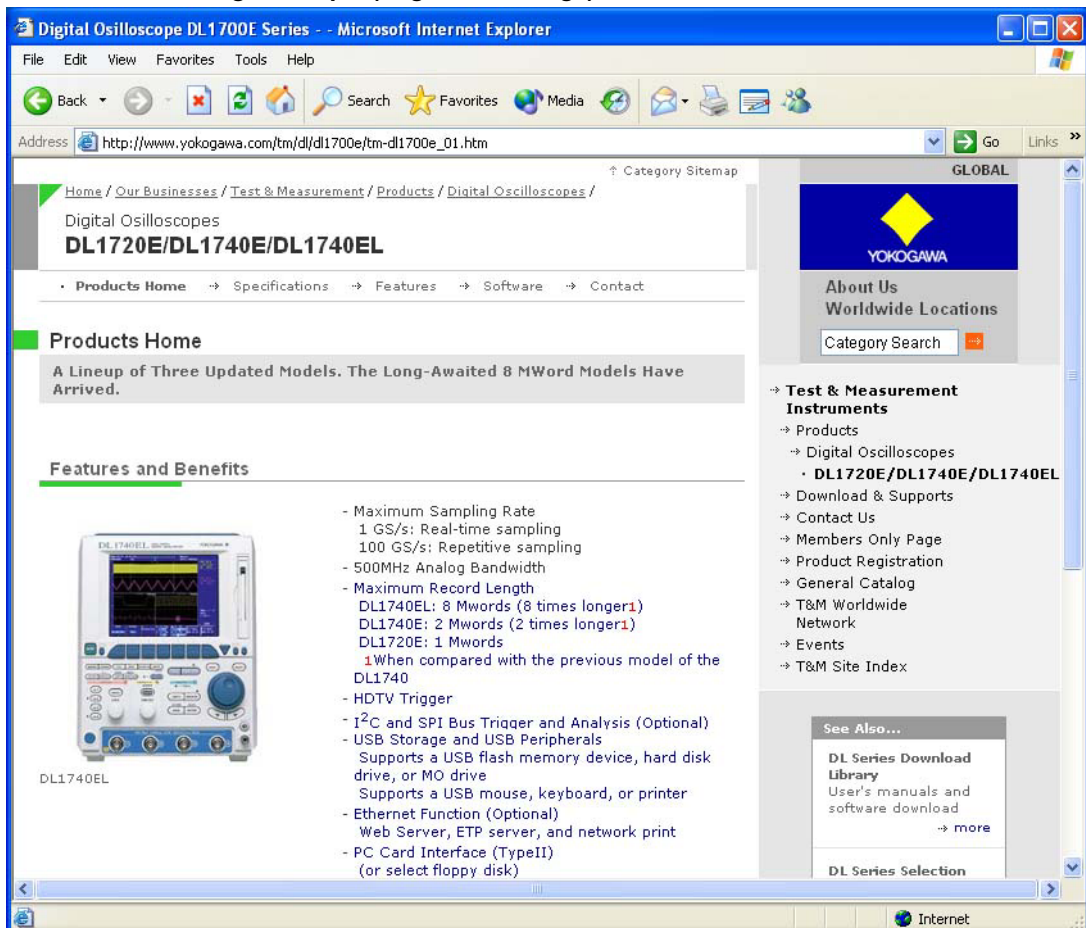

#### Note

- To use the link function, the PC must be connected to the Internet.
- If the message language of the instrument is set to English, the English Web page is displayed; if the message language is set to Japanese or Chinese, the Japanese or Chinese Web page is displayed. For the setup procedure for the message language, see section 15.1.

# 13.8 Setting the Time Difference from GMT (Greenwich Mean Time)

## Procedure

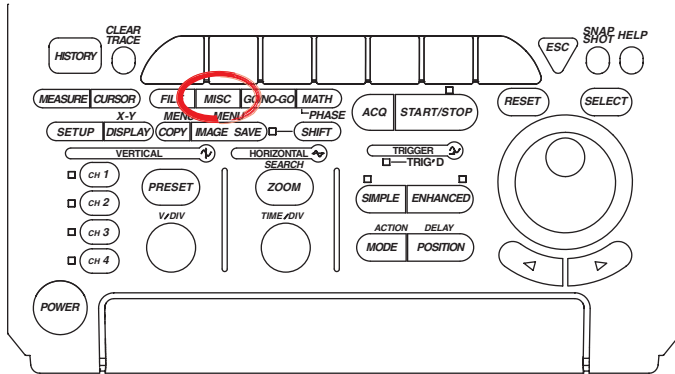

- To exit the menu during operation, press **ESC** located above the soft keys.
- In the procedural explanation below, the term **jog shuttle & SELECT** refers to the operation of selecting/setting items and entering values using the **jog shuttle** and **SELECT** and **RESET** keys. For details on this operation, see sections 4.1 and 4.2.
- For a description of the operation using a USB keyboard or a USB mouse, see section 4.3.

### Setting the Time Difference from GMT (Greenwich Mean Time)

1. Press the **MISC**. The MISC menu appears.
2. Press the **Network** soft key. The Network menu appears.



3. Press the **Others** soft key. The Others dialog box opens.

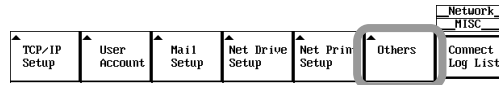

4. Use **jog shuttle & SELECT** to set the Time Hour of Time Difference From GMT in the range of -12 to 13.
5. Likewise, set the Minutes of the Time Difference From GMT in the range of 0 to 59.

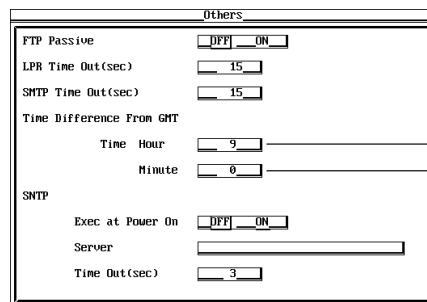

Set the hours.  
Set the minutes.

### Note

The minutes can be set only when the Time Hour is set to 11 to 12. The minutes can not be set if the Time Hour is set to 12 or 13.

## 13.8 Setting the Time Difference from GMT (Greenwich Mean Time)

### Setting SNTP (Simple Network Time Protocol)

6. Use the **jog shuttle** to set Exec at Power On to ON or OFF.
7. Use **jog shuttle & SELECT** to enter Server (IP address of the SNTP server).
8. Use **jog shuttle & SELECT** to enter Time out in the range of 1 to 60 (s).

The screenshot shows a window titled 'Others' with the following settings:

- FTP Passive:  OFF  ON
- LPR Time Out(sec):
- SNTP Time Out(sec):
- Time Difference From GMT:
  - Time Hour:
  - Minute:
- SNTP:
  - Exec at Power On:  OFF  ON
  - Server:
  - Time Out(sec):

Select whether to retrieve (ON) or not retrieve (OFF) time information from an NTP server or SNTP server connected to the network when the power to the DL is turned ON.

Enter the IP address of the SNTP server.

Set the timeout time from 1 to 60(s).

### Explanation

Set the time difference from GMT (Greenwich Mean Time). Make sure to set this value if you are using the Web server function.

#### Setting the Time Difference from GMT (Greenwich Mean Time): Time Hour/Minute

Set the time difference in the range of -12 hours 00 minutes to 13 hours 00 minutes. For example, Japan standard time is ahead of GMT by 9 hours. In this case, set Hour to 9 and Minute to 00.

#### Checking the Standard Time

Check the standard time for the region where the instrument is to be used using one of the following methods.

- Check the date and time settings on your PC.
- Check the site at the following URL:<http://www.worldtimeserver.com/>

#### Note

The instrument does not support daylight savings time. To set the daylight savings time, adjust the time difference from GMT.

#### Setting SNTP

If Exec at Power On is ON, the instrument retrieves date/time information from an NTP server or SNTP server connected to the network when the power to the instrument is turned ON.

#### Note

- If the time difference from GMT (Greenwich Mean Time) is specified, the time is set to a value derived by calculating the difference between the time retrieved from the SNTP server and the time difference.
- The date/time information can also be retrieved from an NTP server or SNTP server when you are setting the date/time on the instrument. For details, see section 3.6, "Setting the Date and Time."
- If you do not wish to retrieve date/time information from the NTP server or SNTP server, leave the IP address blank.

## 13.9 Checking the Presence of the Ethernet Interface (Optional) and the MAC Address

### Procedure

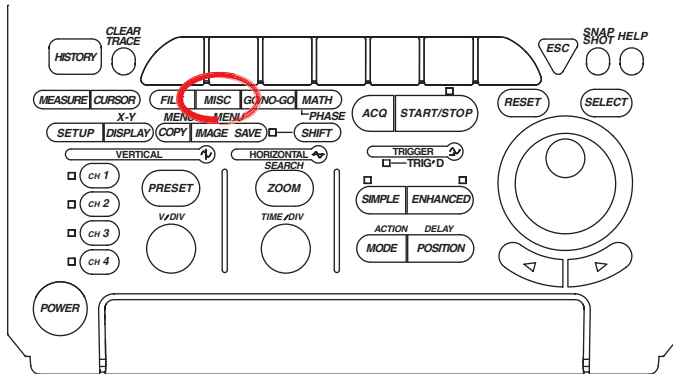

- To exit the menu during operation, press **ESC** located above the soft keys.
- For a description of the operation using a USB keyboard or a USB mouse, see section 4.3.

1. Press the **MISC**. The MISC menu appears.
2. Press the **Overview** soft key. The Overview window opens.

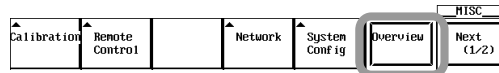

Pressing a panel key other than the **Overview** soft key clears the Overview window.

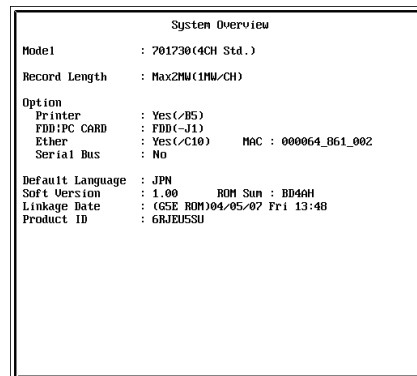

When Ether: Yes(/C10) appears for the Option item in the Overview window, this indicates that the Ethernet interface is installed.

The information displayed on the right (MAC:000064\_841\_002 in the example) is the MAC address.

### Note

- Ether: Yes(/C10) is displayed only if the Ethernet interface option is installed.
- If XXXXXX\_XXX\_XXX is displayed for the MAC address, contact the dealer from which you purchased the instrument.

## 13.9 Checking the Presence of the Ethernet Interface (Optional) and the MAC Address

---

### ***Explanation***

You can check the presence of the Ethernet interface (optional) and the MAC address. MAC address is a unique address that is pre-assigned to the instrument.

#### **The Presence of the Ethernet Interface (Optional)**

Displayed in the Ether section of the Overview window.

Yes: The Ethernet interface is installed.

No: The Ethernet interface is not installed.

#### **MAC Address**

MAC address is a unique address that is pre-assigned to the instrument. It is required in identifying the instruments on the network.

# 13.10 Setting the FTP Passive Mode and LPR/SMTP Timeout

## Procedure

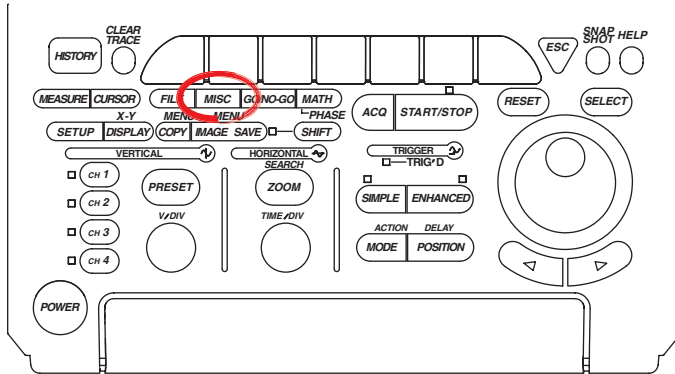

- To exit the menu during operation, press **ESC** located above the soft keys.
- In the procedural explanation below, the term **jog shuttle & SELECT** refers to the operation of selecting/setting items and entering values using the **jog shuttle** and **SELECT** and **RESET** keys. For details on this operation, see sections 4.1 and 4.2.
- For a description of the operation using a USB keyboard or a USB mouse, see section 4.3.

1. Press the **MISC**. The MISC menu appears.
2. Press the **Network** soft key. The Network menu appears.



3. Press the **Others** soft key. The Others dialog box opens.

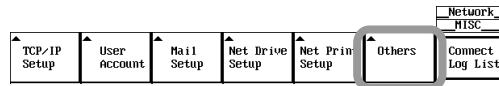

### Turning the FTP Passive Mode ON and OFF

4. Use **jog shuttle & SELECT** to select ON or OFF.

### Setting the LPR Timeout Time

4. Use **jog shuttle & SELECT** to set LPR Time Out.

### Setting the SMTP Timeout Time

4. Use **jog shuttle & SELECT** to set SMTP Time Out.

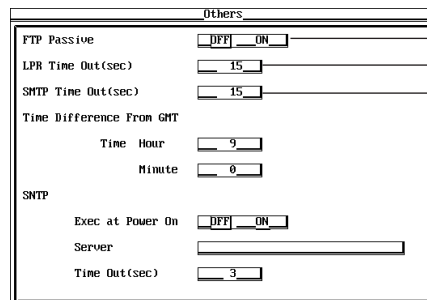

- Sets FTP passive mode.
- Set the LPR Timeout time.
- Set the SMTP Timeout time.

## 13.10 Setting the FTP Passive Mode and LPR/SMTP Timeout

---

### ***Explanation***

You can enter special settings related to the FTP client, LPR, and SMTP. Normally, these parameters do not need to be specified.

#### **Turning the FTP Passive Mode ON and OFF: FTP Passive**

Turn this function ON when using the instrument behind a firewall\* that requires the passive mode. The default setting is OFF.

\* A firewall is furnished on a system that has security features. It prevents intrusion from the outside into the network system.

#### **Setting the LPR Timeout Time: LPR Time Out**

The instrument closes the connection to the printer if there is no response for a certain period of time (timeout time) while it attempts to access the printer. The selectable range is 0 to 3600 (s). The default setting is 15 s.

#### **Setting the SMTP Timeout Time: SMTP Time Out**

When a mail server is accessed from the instrument and connection cannot be established after a certain period of time (timeout time), the instrument decides that the connection to the mail server is not possible and closes the connection. The selectable range is 0 to 3600 (s). The default setting is 15 s.

# 13.11 Using the Instrument as a Network Drive

## Procedure

### L1720E/DL1740E/DL1740EL Settings

Setup TCP/IP and user account and connect to the network according to the procedures given in section 13.2, "Setting Up TCP/IP" and 13.6, "Accessing the instrument from a PC or Workstation (FTP Server Function)."

### Registering the Network Drive on the PC

1. Open My Network Places.
2. From the Tools menu, choose Map Network Drive. The Map Network Drive dialog box opens. Select the drive to be mapped from the Drive list box.
3. In the Folder text box, type the IP address of the instrument in the following format: `http://instrument IP address/dav/`.
4. `http://instrument IP address/dav/`.

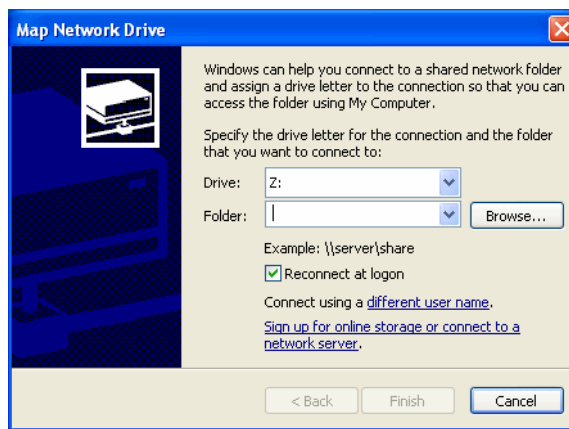

5. Click Finish.  
If a user account is set up with the FTP server function, a dialog box for entering the user name and password opens (see section 13.6, "Accessing the instrument from a PC or Workstation (FTP Server Function)"). If a user account is not set up, the instrument is registered as a network drive.
6. If the dialog box for entering the user name and password opens, enter the user name and password that were created using the User Account function of the instrument, and then click OK.



### Disconnecting the Instrument Mapped as a Network Drive

1. From the Tools menu, choose Disconnect Network Drive. The Disconnect Network Drives dialog box opens.
2. Select the network drive to disconnect and click OK.



### **Explanation**

The external storage medium of the instrument can be used as a network drive on a PC running Windows XP.

### **Network Drives**

You can map the instrument as a network drive on the PC by carrying out the procedure described above. In doing so, you will be able to access the various types of data stored on the instrument's storage medium (floppy disk or PC card) from a software application running on the PC.

### **Note**

---

- Do not change the contents of the DL1720E/DL1740E/DL1740EL drive (including the contents of the drives connected via the USB PERIPHERAL interface) from the PC. Reading the contents of the drive is allowed.
  - Never perform the following operations.
    - Deleting files on the DL1720E/DL1740E/DL1740EL drive from the PC.
    - Adding files on the DL1720E/DL1740E/DL1740EL drive from the PC.
    - Changing the directory structure of the DL1720E/DL1740E/DL1740EL drive from the PC.
  - If you attempt to move a large file from the PC to the DL1720E/DL1740E/DL1740EL, the file may be lost due to the limitations of Windows.
  - You cannot manipulate the files simultaneously from multiple PCs.
  - You cannot view a directory containing 500 or more files.
  - You cannot use the WebDAV function simultaneously with the Web server function.
  - When manipulating files using the network drive function, do not perform other network functions such as the FTP client/server function or Web server function. If you do, the DL1720E/DL1740E/DL1740EL or the PC may become unstable.
  - The DL1720E/DL1740E/DL1740EL can be mapped as a network drive only on Windows XP.
- 

### **Characters That Can Be Used**

This function uses the WebDAV client function on Windows and the WebDAV server function on the instrument. The characters that can be used on the WebDAV server function of the instrument are as follows:

- Uppercase and lower case alphabet characters and space
- Numbers
- The following symbols: ! " # \$ % & ' ( ) + , - . = @ [ ] ^ \_ ` { } ~

Therefore, note the following points.

- You cannot save folders or files that use characters other than those listed above for the names on the instrument storage medium. In addition, these types of files and folders cannot be copied or moved.
- On Japanese versions of Windows XP the default file name for a newly created folder is in Japanese, so a new folder is not created on the instrument's drive.
- Files and folders that use characters other than those listed above on the instrument storage medium do not appear in the file list using WebDAV.
- Files and folders that use characters other than those listed above are excluded from the data capacity calculation. Therefore, the actual used space and the calculated space may differ.

### **File Information**

If a file or folder on the instrument storage medium is copied to a local disk on the PC, the date/time of creation of the file or folder is changed to the date/time when the file or folder is copied.

If a file or folder on a local disk on the PC is copied to the instrument storage medium, the date/time of creation and date/time of modification of the file or folder are changed to the date/time when the file or folder is copied.

# 14.1 External Trigger Input, External Clock Input, and Trigger Gate Input



## CAUTION

Only input signals that meet the specifications below. Otherwise, undesirable signals such as excessive voltage may damage the instrument.

### External Trigger Input Terminal

This terminal is used when an external signal is used as a trigger source (see section 6.6). This terminal is also used as the external clock input terminal (EXT CLOCK IN) and the trigger gate input terminal (TRIG GATE IN).

On the DL1740E/DL1740EL, the terminal is labeled EXT CLOCK IN/EXT TRIG IN/TRIG GATE IN (rear panel), and on the DL1720E it is labeled EXT (front panel).

Item	Description
Connector type	BNC
Maximum input voltage	$\pm 40$ V (DC+ACpeak) or 28 Vrms when the frequency is 10 kHz or DC to 100 MHz
Input frequency bandwidth	DC to 100 MHz
Input impedance	Approximately 1 M $\Omega$ and approximately 20 pF
Input range	$\pm 2$ V (for the DL1740E/DL1740EL) $\pm 1$ V (when the $\pm 1$ V range is set on the DL1720E) $\pm 10$ V (when the $\pm 10$ V range is set on the DL1720E)
Trigger sensitivity	0.1 Vp-p (for the DL1740E/DL1740EL) $\pm 0.1$ Vp-p (when the $\pm 1$ V range is set on the DL1720E) $\pm 1$ Vp-p (when the $\pm 10$ V range is set on the DL1720E)
Trigger level	$\pm 2$ V, setting resolution is 5 mV (on the DL1740E/DL1740EL) $\pm 1$ V, setting resolutions of 5 mV (when the $\pm 1$ V range is set on the DL1720E) $\pm 10$ V, setting resolutions of 50 mV (when the $\pm 1$ V range is set on the DL1720E)

#### [Input terminal]

For the DL1740E/DL1740EL  
(terminal on the rear panel)

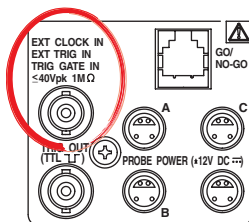

For the DL17420E  
(terminal on the front panel)



## 14.1 External Trigger Input, External Clock Input, and Trigger Gate Input

### External Clock Input Terminal

Use this terminal if you wish to operate the instrument using an external clock signal (see section 5.10). This terminal is also used as the external trigger input terminal (EXT TRIG IN) and the trigger gate input terminal (TRIG GATE IN).

On the DL1740E/DL1740EL, the terminal is labeled EXT CLOCK IN/EXT TRIG IN/TRIG GATE IN (rear panel), and on the DL1720E it is labeled EXT (front panel).

Item	Description
Connector type	BNC
Maximum input voltage	$\pm 40$ V (DC+ACpeak) or 28 Vrms when the frequency is 10 kHz or 40 Hz to 20 MHz (continuous clock only)
Frequency range	Approximately 1 M $\Omega$ and approximately 20 pF
Input impedance	$\pm 2$ V (for the DL1740E/DL1740EL)
Input range	$\pm 1$ V (when the $\pm 1$ V range set on the DL1720E) $\pm 10$ V (when the $\pm 10$ V range set on the DL1720E)
Threshold level	$\pm 2$ V, setting resolution is 5 mV (on the DL1740E/DL1740EL) $\pm 1$ V, setting resolutions of 5 mV (when the $\pm 1$ V range set on the DL1720E) $\pm 10$ V, setting resolutions of 50 mV (when the $\pm 10$ V range set on the DL1720E)
Minimum input amplitude	0.1 Vp-p (for the DL1740E/DL1740EL) $\pm 0.1$ Vp-p (when the $\pm 1$ V range set on the DL1720E) $\pm 1$ Vp-p (when the $\pm 10$ V range set on the DL1720E)
Minimum pulse width	10 ns or more for High and Low.

#### [Input terminal]

For the DL1740E/DL1740EL  
(terminal on the rear panel)

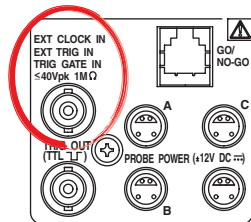

For the DL17420E  
(terminal on the front panel)

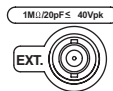

#### Note

The threshold level for the external clock input and the trigger level for the external trigger input are common.

### Trigger Gate Input Terminal

The terminal is used when you wish to activate the trigger using an external signal (see section 6.16). This terminal is also used as the external trigger input terminal (EXT TRIG IN) and the external clock input terminal (EXT CLOCK IN). On the DL1740E/DL1740EL, the terminal is labeled EXT CLOCK IN/EXT TRIG IN/TRIG GATE IN (rear panel), and on the DL1720E it is labeled EXT (front panel).

Item	Description
Connector type	BNC
Maximum input voltage	$\pm 40$ V (DC+ACpeak) or 28 Vrms when the frequency is 10 kHz or DC to 50 MHz
Frequency range	DC to 50 MHz
Input impedance	Approximately 1 M $\Omega$ and approximately 20 pF
Input range	$\pm 2$ V (for the DL1740E/DL1740EL) $\pm 1$ V (when set to the $\pm 1$ V range on the DL1720E) $\pm 10$ V (when set to the $\pm 10$ V range on the DL1720E)
Minimum input amplitude	0.1 Vp-p (for the DL1740E/DL1740EL) 0.1 Vp-p (when set to the $\pm 1$ V range on the DL1720E) 1 Vp-p (when set to the $\pm 10$ V range on the DL1720E)
Minimum pulse width	10 ns or more for High and Low

**[Input terminal]**

**For the DL1740E/DL1740EL  
(terminal on the rear panel)**

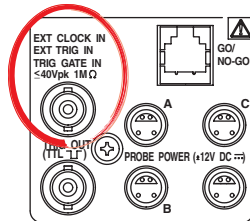

**For the DL17420E  
(terminal on the front panel)**

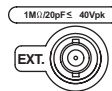

**Note**

The determination level for the trigger gate input and the trigger level for the external trigger input are common.

## 14.2 Trigger Output (TRIG OUT)



### CAUTION

Never apply external voltage to the TRIG OUT terminal. Doing so can cause damage to the instrument.

### Trigger Output Terminal

A TTL level signal is output when a trigger is activated. The signal level is normally high and goes low when a trigger is activated.

Item	Description
Connector type	BNC
Output level	TTL
Output logic	$\overline{1}$ (Negative)
Output delay time	50 ns or less
Output hold time	1 $\mu$ s minimum for low level and 100 ns minimum for high level

#### [Input terminal]

For the DL1740E/DL1740EL

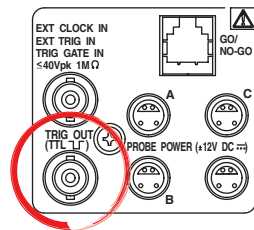

For the DL17420E

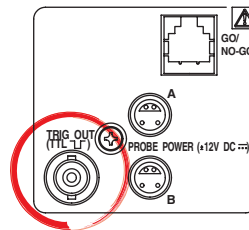

### Circuit Diagram of the Output Section

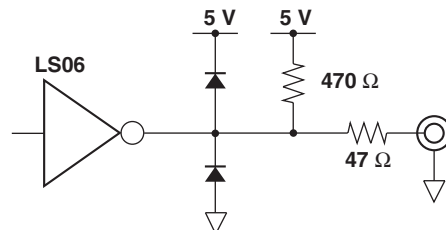

### Output Timing

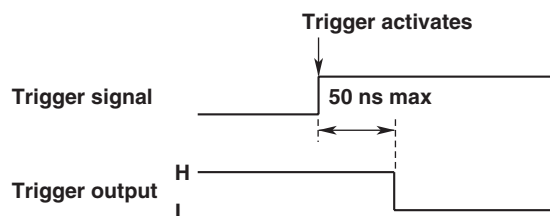

Low Level/High Level Hold Time

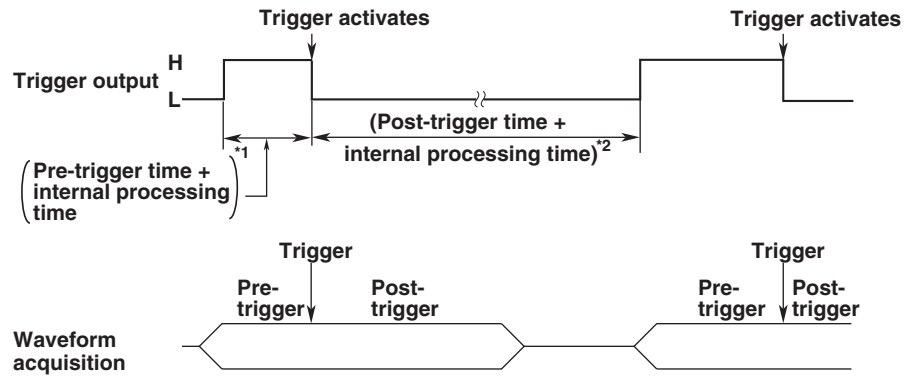

1. HIGH (high level) interval: Indicates the pre-trigger and internal processing time. 100 ns minimum.
2. LOW (low level) interval: Indicates the post-trigger and internal processing time. 1  $\mu$  s minimum.

## 14.3 Video Signal Output (VIDEO OUT (VGA))



### CAUTION

- Connect the cable after turning OFF the instrument and the monitor.
- Do not short the VIDEO OUT (VGA) terminal or apply external voltage to it. Doing so can cause damage to the instrument.

### Video Output Terminal

The instrument display can be output to a monitor through the RGB output. Connectable monitors are VGA monitors or multi-sync monitors capable of displaying VGA.

Pin No.	Signal Name	Description
1	Red	0.7 V <sub>p-p</sub>
2	Green	0.7 V <sub>p-p</sub>
3	Blue	0.7 V <sub>p-p</sub>
4	-	
5	-	
6	GND	
7	GND	
8	GND	
9	-	
10	GND	
11	-	
12	-	
13	Horizontal sync signal	Approx. 31.3 kHz, TTL negative logic $\sqcup$
14	Vertical sync signal	Approx. 60 Hz, TTL negative logic $\sqcup$
15	-	

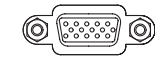

VIDEO OUT (VGA)

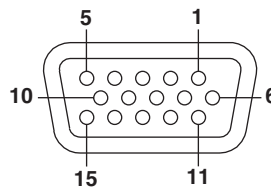

D-Sub 15-pin receptacle

### Connecting to the Monitor

1. Turn OFF the instrument and monitor.
2. Connect the instrument and the monitor using an analog RGB cable.
3. The screen of the instrument appears on the monitor when both the instrument and the monitor are turned ON.

### Note

- The RGB video signal is constantly output from the VIDEO OUT (VGA) terminal.
- The monitor screen may flicker if the instrument or another instrument is brought close to the monitor.
- The edge of the screen may drop out depending on the monitor type.

# 15.1 Changing the Message and Menu Language and Turning the Click Sound ON and OFF

## Procedure

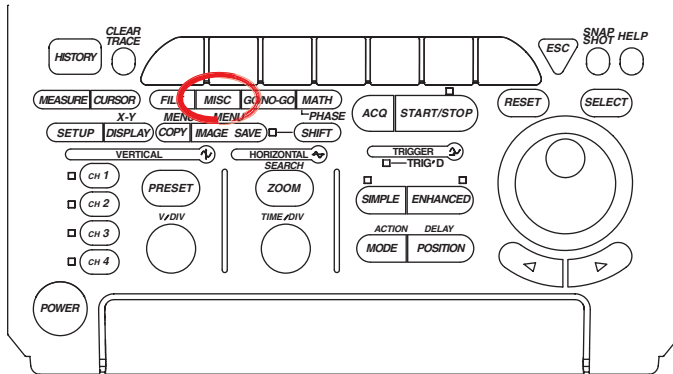

- To exit the menu during operation, press **ESC** located above the soft keys.
- For a description of the operation using a USB keyboard or a USB mouse, see section 4.3.

1. Press the **MISC**. The MISC menu appears.
2. Press the **System Config** soft key to display a configuration menu.

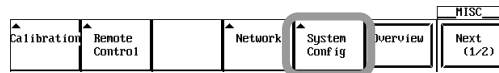

### Setting the Menu Language

3. Press the **Menu Language** soft key to select ENG or CHN.

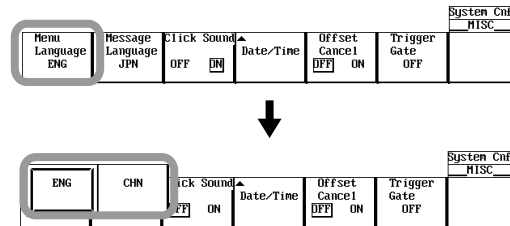

### Setting the Message Language

3. Press the **Message Language** soft key to select JPN, ENG, or CHN.

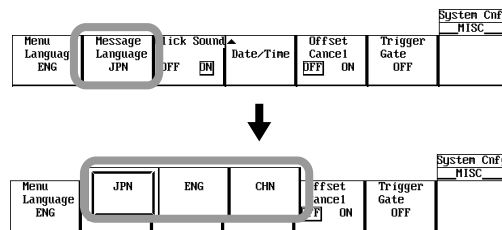

### Turning the Click Sound ON and OFF

3. Press the **Click Sound** soft key to select ON or OFF.





## 15.1 Changing the Message and Menu Language and Turning the Click Sound ON and OFF

---

### ***Explanation***

#### **Setting the Menu Language**

You can set the menus to display in English (ENG) or Chinese (CHN).

#### **Setting the Message Language**

When errors occur, and at other times, messages appear. You can specify to have these messages displayed in Japanese (JPN), English (ENG) or Chinese (CHN). The messages codes are common to each of these languages.

For details on messages, see section 16.2.

#### **Turning the Click Sound ON and OFF**

You can turn the click sound that is heard when the jog shuttle is turned ON and OFF . The default setting is ON.

## 15.2 Changing the USB Keyboard Language and Checking the Connected USB Keyboard

### Procedure

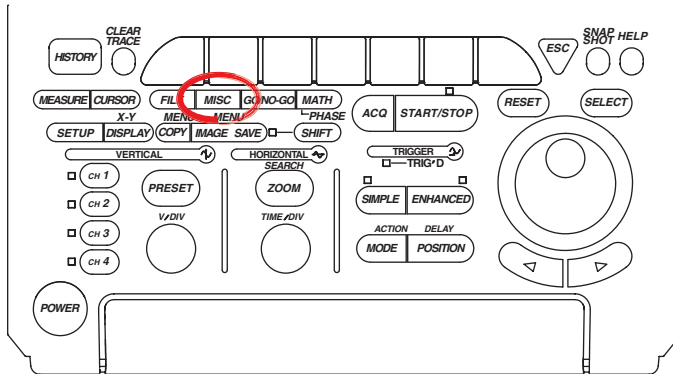

- To exit the menu during operation, press **ESC** located above the soft keys.
- For a description of the operation using a USB keyboard or a USB mouse, see section 4.3.

1. Press the **MISC**. The MISC menu appears.
2. Press the **Next (1/2)** soft key. The page 2 menu appears.

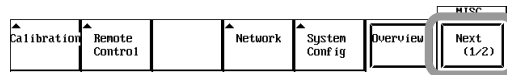

3. Press the **USB** soft key.

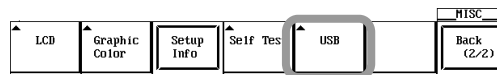

### Setting the Keyboard Language

4. Press the **Keyboard** soft key to select JPN or ENG.

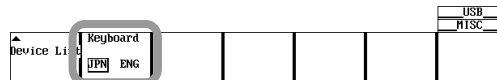

### Checking the Connected Keyboard

4. Press the **Device List** soft key. The USB Device List window appears.

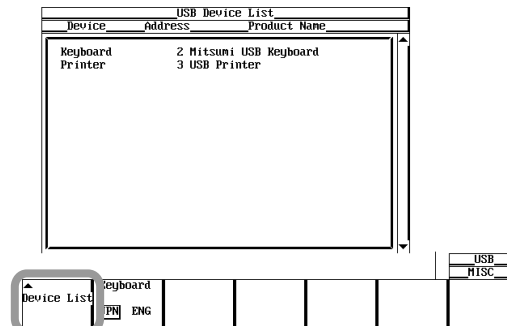

## 15.2 Changing the USB Keyboard Language and Checking the Connected USB Keyboard

---

### ***Explanation***

#### **USB Keyboard Language**

You can select the language of the USB keyboard that is used to enter items such as file names and comments (see section 4.3). Keyboards conforming to USB Human Interface Devices (HID) Class Version 1.1 can be used.

ENG: 104 keyboard and 89 keyboard

JPN: 109 keyboard and 89 keyboard

The character that is entered through each key of the USB keyboard varies depending on the keyboard type. For details, see appendix 5.

#### **Checking the Connected Keyboard**

The USB devices that are connected can be listed.

#### **Note**

---

For USB keyboards that have been tested for compatibility, contact your nearest YOKOGAWA dealer.

---

## 15.3 Measuring the Offset Voltage and Applying the Offset Voltage to the Computed Results

### Procedure

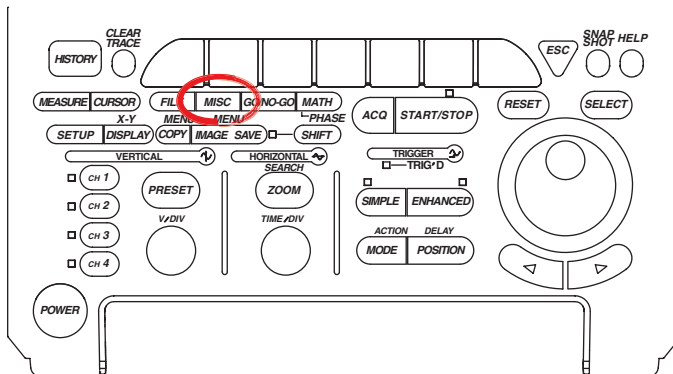

- To exit the menu during operation, press **ESC** located above the soft keys.
- For a description of the operation using a USB keyboard or a USB mouse, see section 4.3.

1. Press the **MISC**.
2. Press the **System Cnfg** soft key to display a configuration menu.

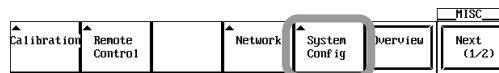

3. Press the **Offset Cancel** soft key to select ON or OFF. The default setting is OFF.

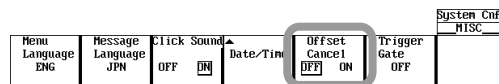

### Explanation

The offset value that is specified for each channel can be subtracted from the input signal and used for computation and automated measurement.

**OFF:** The offset value is not applied to computed results and the results of automated measurements.

Waveform is observed without subtracting the offset voltage (DC voltage) from the input signal.

The vertical position of the screen corresponds to the offset voltage.

**ON:** The offset value is applied to computed results and the results of automated measurements.

The offset value specified for each channel can be used to subtract the offset voltage (DC voltage) from the input signal for waveform observation. The vertical position is set to 0 V.

### Note

The Offset Cancel setting applies to all channels.

To specify whether to cancel or not cancel the offset voltage for each channel separately, use the linear scaling function.

# 15.4 Setting the Screen Color and Intensity

## Procedure

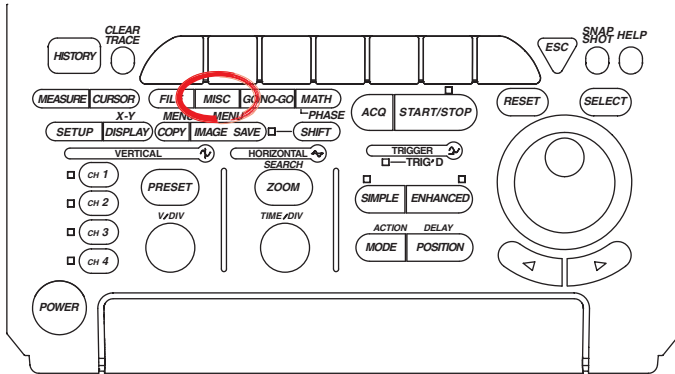

- To exit the menu during operation, press **ESC** located above the soft keys.
- In the procedural explanation below, the term **jog shuttle & SELECT** refers to the operation of selecting/setting items and entering values using the **jog shuttle** and **SELECT** and **RESET** keys. For details on this operation, see sections 4.1 and 4.2.
- For a description of the operation using a USB keyboard or a USB mouse, see section 4.3.

1. Press the **MISC**. The MISC menu appears.
2. Press the **Next (1/2)** soft key. The page 2 menu appears.

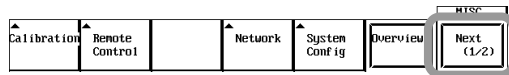

3. Press the **Graphic Color** soft key. The Graphic Color menu appears.

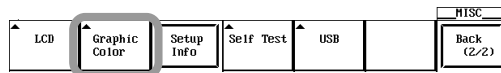

4. Press the **Mode** soft key. The Mode menu appears.

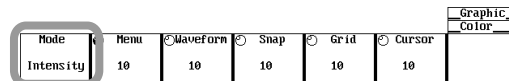

### Setting the Display Color

5. Press the **RGB** soft key. The RGB menu appears.

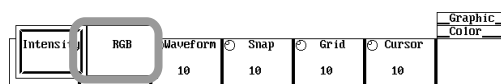

6. Press the **Menu** soft key. The Menu dialog box opens.

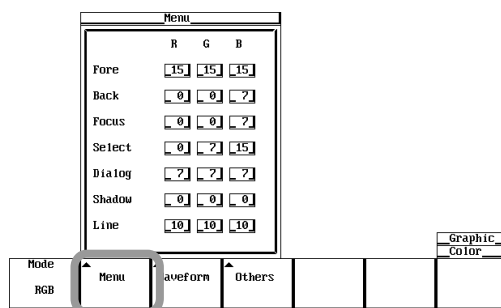

7. Use **jog shuttle & SELECT** to set the menu screen color.
8. Press **ESC**. The Menu dialog box closes.

- Likewise, set the colors for **Waveform** and **Others**.  
CH3, CH4, and Math2 are not displayed on the DL1720E.

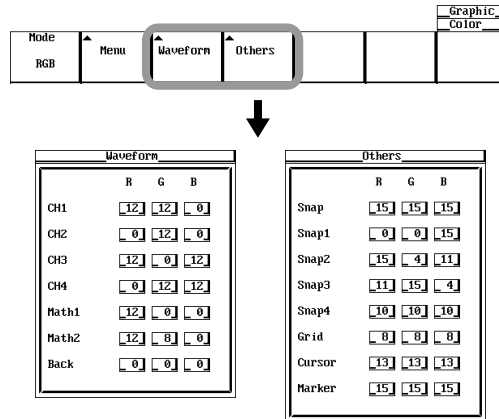

### Setting the Intensity

- Press the **Intensity** soft key. The Intensity menu appears.

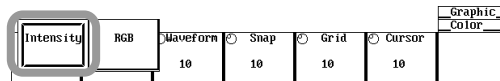

- Press the **Menu** soft key.
- Turn the **jog shuttle** to set the intensity of the menu screen.
- Likewise, set the intensity of **Waveform**, **Snap**, **Grid**, and **Cursor**.

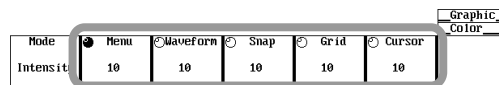

## 15.4 Setting the Screen Color and Intensity

---

### *Explanation*

#### **Display Color**

You can set the screen color using a ratio of red (R), green (G), and blue (B) for each item. The selectable range is 0 to 15 levels, and the resolution is 1 level.

<b>Item</b>	<b>Target</b>
<b>Menu</b>	
Fore	Menu
Back	Background color
Focus	Selection cursor
Select	Selected menu
Dialog	Dialog box
Shadow	Background color of the selected menu
Line	Menu screen lines
<b>Waveform</b>	
CH1-CH4, Math1, Math2	Waveform color (CH1 to CH2, and Math1 on the DL1720E)
Back	Background color of the waveform display area
<b>Other</b>	
Snap	Snapshot waveforms
Snap1-4	Loaded snapshot waveforms
Grid	Grid
Cursor	Cursor
Marker	Marker

#### **Intensity**

You can set the intensity in the range of 1 to 15 levels for each item. The selectable range is 0 to 15 levels, and the resolution is 1 level.

<b>Item</b>	<b>Target</b>
Menu	Menu screens
Waveform	Waveform
Snap	Snapshot waveforms
Grid	Grid
Cursor	Cursor

# 15.5 Turning OFF the Backlight and Setting the Brightness of the Backlight

## Procedure

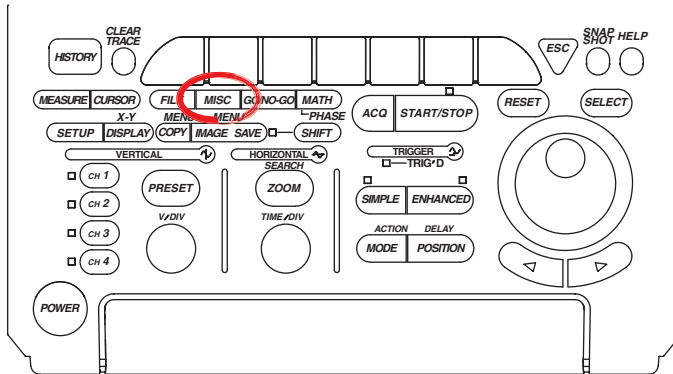

- To exit the menu during operation, press **ESC** located above the soft keys.
- For a description of the operation using a USB keyboard or a USB mouse, see section 4.3.

1. Press the **MISC**. The MISC menu appears.
2. Press the **Next (1/2)** soft key. The page 2 menu appears.

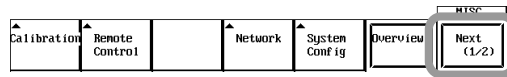

3. Press the **LCD** soft key. The LDC menu is displayed.

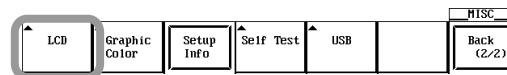

### Setting the Hold Off

4. Press the **Auto OFF** soft key to select ON or OFF.  
If you set Auto OFF to ON, the Auto OFF Time menu appears. Proceed to step 5.



5. Press the **Time** soft key.
6. Turn the **jog shuttle** to set the time when the backlight will automatically turn OFF.



### Setting the Backlight Brightness

6. Press the **Brightness** soft key.
7. Turn the **jog shuttle** to set the backlight brightness.

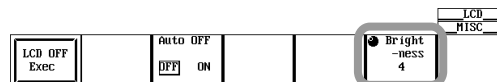

### Turning the Backlight ON and OFF

7. Press the **LCD OFF Exec** soft key. The backlight turns OFF.  
Pressing any panel key turns the backlight ON allowing the screen to be viewed.

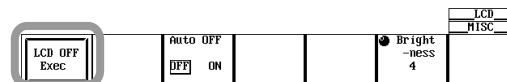



### *Explanation*

#### **Turning the Backlight ON and OFF**

You can turn ON/OFF the LCD backlight.

- Pressing the LCD OFF EXEC soft key turns OFF the backlight.
- Pressing any panel key turns the backlight ON allowing the screen to be viewed.

#### **Backlight Auto OFF**

The backlight automatically turns OFF if there is no key operation for the specified time.

The selectable time is 1 to 60 min, and the resolution is 1 min.

#### **Backlight Brightness**

You can change the brightness of the backlight. Dimming the backlight brightness or leaving the backlight turned OFF prolongs its life. The selectable range is 1 to 4 levels, and the resolution is 1 level.

# 16.1 Malfunction? First, Investigate.

## Corrective Actions When Abnormalities Occur

- Refer to the following pages when error messages appear on screen.
- Contact the dealer from which you purchased the instrument if servicing is required, or if the instrument fails to operate normally after taking appropriate corrective actions.

Description	Probable Cause	Corrective Action	Reference Section
The power cannot be turned ON.	Using a power supply outside the ratings.	Use a correct power supply.	3.3
	The main power switch on the rear panel is not turned ON.	Turn ON the main power switch.	3.3
Nothing is displayed.	The backlight is turned OFF.	Press any key.	15.5
	The screen colors are not appropriate.	Set the screen color.	15.4
The display is odd.	The system is not operating properly.	Power-cycle the DL1720E/DL1740E/DL1740EL.	3.3
The waveform display does not update.	Waveform data was loaded from an external storage medium.	Unload the loaded waveform data.	12.5
Keys do not work.	The DL1720E/DL1740E/DL1740EL is in remote mode.	Press SHIFT + CLEAR TRACE to enable local mode.	–
	Other causes.	Perform a key test. If the test fails, servicing is required.	16.3
Trigger does not activate.	The trigger gate is enabled.	Turn OFF the trigger gate.	6.16
	The trigger settings are not appropriate.	Set the trigger conditions correctly.	Chapter 6
Measured values are not correct.	Insufficient warm-up.	Warm up the DL1720E/DL1740E/DL1740EL for 30 minutes after turning on the power.	–
	Not calibrated.	Execute calibration.	4.6
	The probe's phase has not been corrected.	Perform phase correction correctly.	3.5
	The probe attenuation is not correct.	Set an appropriate value.	5.5
	An offset voltage is added.	Set the offset voltage to 0 V.	5.6
	Other causes.	Execute calibration. If the measured value is still odd, servicing is required.	4.6
Cannot output to the built-in printer.	The printer head is damaged or worn out.	Servicing required.	–
Cannot save to the specified medium.	The medium is not formatted.	Format the medium.	12.4
	The medium is write-protected.	Release the medium's write-protect.	–
	No more free space on the medium.	Delete unneeded files or use another storage medium.	12.11
Cannot change settings or control the operation of the DL1720E/DL1740E/DL1740EL via the communication interface.	The address of the DL1720E/DL1740E/DL1740EL used by the program is different from the specified address.	Match the address used in the program to the address of the DL1720E/DL1740E/DL1740EL.	Communication Interface User's Manual (IM 701730-17E, CD-ROM)
	The interface is not used in a way that conforms to the electrical or mechanical specifications.	Use it in a way that conforms to the specifications.	

## 16.2 Messages and Corrective Actions

### Error Messages

A message (such as an error message) may appear during operation. This section describes the meanings of the messages and their corrective actions. The messages can be displayed either in English or Japanese (see section 15.1). Contact the dealer from which you purchased the instrument if servicing is required.

The following messages appear in Japanese in the upper row, and English in the bottom row. In addition to the messages listed below, there are communication error messages. These messages are described in the Communication Interface User's Manual (IM 701730-17E).

### Status Messages

Code	Message	Corrective Action	Sections
0	Aborted hard copy.	–	11.2
1	Aborted file operation.	–	Chapter 12
2	Completed data store.	–	12.1
3	Completed data recall.	–	12.1
4	Completed GO/NO-GO.	–	10.9, 10.10
10	Set to remote mode by communication commands.	Press SHIFT + CLEAR TRACE to enable local mode.	–
11	Local lockout by communication commands.	To operate the keys, release lockout using communication commands.	–
13	All settings will be initialized. Power up with the RESET key depressed.	–	4.4
21	Completed action-on-trigger.	–	6.15
22	Executed unload.	–	12.5, 12.7
23	Released the Preview mode.	–	11.2
24	Some of the channels are set to 50 ohm DC input. To keep the settings, press the SELECT key. Pressing any other key will change the settings to 1 Mohm DC input.	–	5.4
25	Aborted the search.	–	10.2 to 10.4
26	Executed the search, but no record was found that matched the conditions.	–	10.2 to 10.4
27	Executed the search, but no pattern was found that matched the conditions.	–	10.2 to 10.4
28	Pattern contains points that are between Thr Lower and Thr Upper.	–	10.4
29	MATH will be performed on all records. Abort the operation by setting the history Display Mode to One.	–	–
30	Aborted the recalculation of the MATH.	–	–
32	Aborted statistical measurement processing.	–	10.7
36	Key invalid for this model.	–	–
48	Abort process is running. Wait until the process completes.	–	–

**Errors in Execution (600 to 799)**

<b>Code</b>	<b>Message</b>	<b>Corrective Action</b>	<b>Sections</b>
601	Invalid file name.	Check the file name.	12.4 to 12.8
602, 603	No USB device or no storage media inserted.	Check the USB device connection, and the presence of a storage medium.	–
604	Storage media failure.	Check the storage medium.	–
605	File not found.	Check the file name and storage medium	Chapter 12
606	Storage media is protected.	Turn OFF the write-protect switch on the storage medium.	–
607	Storage media failure.	Check the storage medium.	–
608-610	Invalid file name.	Check the file name.	12.4 to 12.8
611, 612	Storage media full.	Delete unneeded files or use another storage medium.	12.11
613	Cannot delete a directory if there are files in the directory.	Delete all the files in the directory to be deleted.	12.11
614	File is protected.	Change the attribute to R/W.	12.11
615	Physical format error.	Reformat the storage medium. If the same error occurs, the storage medium cannot be formatted using the DL1720E/DL1740E/DL1740EL.	12.4
616-620	File system failure.	Check using a different storage medium. If it still fails, servicing required.	–
621	File is damaged.	Check the file.	–
622-641 656-663	File system failure.	Check using a different storage medium. If it still fails, servicing required.	–
642	No storage media exists in USB device.	Check the presence of the storage medium of the USB device.	–
646-653	Storage media failure.	Check the storage medium.	–
654	Storage media failure.	Check the format type of the floppy disk.	12.4
665	Cannot load this file format.	Files saved on other models (such as YOKOGAWA – DL/AG Series) cannot be loaded.	–
666	File is now being accessed. Wait a moment.	Execute after the access is finished.	–
667	Cannot be executed while data acquisition is in progress.	Press the START/STOP key to stop the waveform acquisition first.	7.1
668	Cannot find “.HDR” file.	Check the file.	12.5
669	Cannot load the specified file on this ROM version or this model.	Upgrade the firmware.	–
671	Save data not found.	Check the existence of the data to be saved.	–
676	Unknown file format.	Check whether the data is in a format that the DL1720E/DL1740E/DL1740EL can handle. Change the extension	12.5 to 12.9
677	P-P compression cannot be used to save FFT waveforms.	Turn OFF the P-P compression and save the data.	12.5
679	Data that have been P-P compressed and saved cannot be loaded.	–	–
680	Illegal printer head position.	Move the release arm to the HOLD position.	11.1
681	Paper empty.	Install the roll paper.	11.1
682	Printer overheated.	Turn OFF the power immediately. Servicing required.	–
683	Printer overheated.	Turn OFF the power immediately. Servicing required.	–
684	Printer is not installed.	Check the specifications to see if your model has the optional printer.	Page ii
685	Printer time out.	Servicing required.	–
691	The printer has malfunctioned.	Servicing required.	–
692	Printer error. Turn the power of the printer from OFF to ON.	–	–

## 16.2 Messages and Corrective Actions

Code	Message	Corrective Action	Sections
693	Printer offline.	–	–
694	Out of paper.	–	–
695	Printer is in use.	–	–
696	Cannot detect printer. Turn ON the printer. Check connectors.	–	–
697	No files supporting the thumbnail display window.	–	12.10
701	Cannot be executed while data acquisition is acquisition first.	Press the START/STOP key to stop the waveform.	7.1
703	There is no data to be undone.	Undo is not possible because the data immediately before the initialization or auto setup does not exist.	4.4, 4.5
704	Cannot be executed while data acquisition is acquisition first.	Press the START/STOP key to stop the waveform.	7.1
705	Cannot be executed while data store/recall is in progress.	–	12.1
706	There is no data to be recalled.	–	12.1
707	Cannot start during data output.	Wait until the output is complete.	Chapter 11
711	Cannot access file while hard-copying.	Wait until the output is complete.	11.2
712	Cannot compress this screen image. Turn off the compression switch.	Turn OFF the compression setting.	12.9
713	Calibration failure. Disconnect the input and execute again. If it fails again, servicing is required.	Servicing required.	–
726	Cannot start when loading waveform data that has been saved in history All mode.	Execute unload.	12.5
727	Insufficient output data. Increase Mag or widen the Time Range interval.	Increase Mag or widen the Time Range interval.	11.2
728	Hard copying. Abort or wait until it is complete.	Press COPY again to abort.	11.2
729	Cannot perform calibration while waveform data is loaded.	Unload the loaded waveform using the FILE menu.	12.5
730	Pattern is not specified.	Set at least one of the search pattern to a value other than x.	10.4
731	Cannot start when waveform data that has been acquired in the linear average mode is loaded.	Unload the loaded waveform using the FILE menu.	12.5
732	Cannot be executed while computation is in progress.	Turn OFF Display of the MATH menu and abort the computation.	9.1
733	Failed to measure statistics. The target waveform data exists or the measured waveform data may not exist. If Cycle Statistics is specified, the instrument may be configured in a way that fails to detect the cycle.	Check to see that waveform data to be measured exists and that there is at least one cycle of waveform within the measurement range.	10.7
735	Cannot store because the data is locked. Release the lock through Store Detail.	Release the lock through Store Detail.	12.1
736	The File item is inappropriate. Select Waveform, Snap, or Measure.	Select Waveform, Snap, or Measure.	–
737	Executing file Load, Save, or Format. Abort or wait until it is complete.	–	–
738	Hard copying or saving image. Abort or wait until it is complete.	–	–
750	Cannot connect to the server.	Check network configuration and connection.	Chapter 13
751	Not yet connected to the ftp server.	Check network configuration and connection.	Chapter 13
752	This ftp function in not supported.	–	Chapter 13
753	FTP Error: Pwd	Check network configuration and connection.	Chapter 13
754	FTP Error: Cwd	Check network configuration and connection.	Chapter 13

Code	Message	Corrective Action	Sections
755	FTP Error: Rm	Check network configuration and connection.	Chapter 13
756	FTP Error: List	Check network configuration and connection.	Chapter 13
757	FTP Error: Mkdir	Check network configuration and connection.	Chapter 13
758	FTP Error: Rmdir	Check network configuration and connection.	Chapter 13
759	FTP Error: Get	Check network configuration and connection.	Chapter 13
760	FTP Error: Put	Check network configuration and connection.	Chapter 13
761	FTP Error: GetData	Check network configuration and connection.	Chapter 13
762	FTP Error: PutData	Check network configuration and connection and disk space.	Chapter 13
763	FTP Error: AppendData	Check network configuration and connection and disk space.	Chapter 13
764	FTP Error: Client Handle	Check network configuration and connection.	Chapter 13
765	FTP Error: Others	Check network configuration and connection.	Chapter 13
785	Cannot send data to a network printer.	Check network configuration and connection.	Chapter 13
786	Cannot send the e-mail message.	Check network configuration and connection.	Chapter 13
797	Connecting to a NetDrive. Wait until connection has been established.	–	Chapter 13

### Errors in Setting (800 to 899)

Code	Message	Corrective Action	Sections
800	Illegal date/time.	Set them correctly.	3.6
801	Illegal file name.	Illegal character exists, or the file name is restricted by MS-DOS. Enter a different file name.	4.2
804	Cannot change this parameter while data acquisition is in progress.	Press the START/STOP to stop the waveform acquisition first.	7.1
806	GO/NO-GO is in execution Please press the Abort key.	Abort GO/NO-GO.	10.9, 10.10
814	Duplicated label.	Set a different label.	8.9
819	Cannot change when Channel Display is OFF or Math settings are invalid.	Turn ON the channel display or set the computation.	5.1, 9.1
821	Cannot change when ExtClock is active.	Set the time base to Internal.	5.10
836	Cannot change settings during action-on-trigger.	Abort action-on-trigger.	6.15, 7.1
840	Cannot set the acquisition mode to Average when the trigger mode is set to Single or Single(N).	Change the acquisition mode or change the trigger mode.	6.1, 7.5
841	It is not possible to make a setting that will result in the repetitive mode when the trigger mode is set to Single(N).	Set the trigger mode to a mode other than Single(N).	6.1
842	Cannot specify A->B(N) and A Delay B when the trigger gate is active.	Turn OFF the trigger gate.	6.16
843	Cannot set the trigger mode to Single or Single(N) when the acquisition mode is Average.	Change the acquisition mode or change the trigger mode.	6.1, 7.5
846	Cannot set the trigger mode to Single(N) during repetitive sampling mode.	Turn OFF the repetitive mode, lower T/div, or shorten the record length.	5.11, 7.4
847	Cannot set this parameter during repetitive sampling mode.	Turn OFF the repetitive mode, lower T/div, or shorten the record length.	5.11, 7.4
848	Not possible during the interleave mode.	Turn OFF interleave mode.	7.3
850	Not possible in the current record length.	Change the record length.	7.2
851	Cannot carry out computation at the current record length.	Change the record length.	7.2
852	The operation is not possible when waveforms are loaded. Unload the loaded files from the FILE menu.	Execute unload.	12.5

## 16.2 Messages and Corrective Actions

Code	Message	Corrective Action	Sections
853	Setting or executing is not possible during the search operation.	Abort the search.	10.2 to 10.4
854	Search pattern does not exist. Execute the search.	Change the search conditions and search again.	10.4
855	Settings cannot be changed or executed during the history search operation.	Abort the search.	10.2, 10.3
856	The record cannot be selected.	Check the record number using Show Map.	10.2, 10.3
857	History record does not exist.	History record is not possible in average mode, repetitive sampling mode, and roll mode.	7.4, 7.5
858	Settings or executing is not possible during FFT recalculation. Abort the operation by setting the history Display Mode to One.	Set Display Mode on the HISTORY menu to One.	10.1
860	Cannot be configured or executed while updating the history all display. Aborted when history display mode is set to One.	Set Display Mode on the HISTORY menu to One.	10.1
861	Cannot output color in this format.	Turn OFF the color.	11.3
862	Zones cannot be edited in the following cases: <ul style="list-style-type: none"><li>• When the main window is not displayed.</li><li>• When the target waveform is not displayed.</li></ul>	Display the main window and the target waveform.	10.9
863	The zone waveform does not exist.	Create the zone waveform.	10.9
864	The zone is being edited. To perform other operations, select Quit to exit zone editing.	Select Quit to exit zone editing.	10.9
865	Zones determination is not possible in the following cases: <ul style="list-style-type: none"><li>• When the main window is not displayed.</li><li>• When the target waveform is not displayed.</li><li>• When the zone waveform does not exist.</li></ul>	Display the main window and the target window and create the zone waveform.	10.9
868	Processing statistics. To perform other operations, abort the statistical processing.	Abort statistical processing.	10.7

### Error in System Operation (900 to 908, 912 to 914)

Code	Message	Corrective Action	Sections
901	Failed to backup setup data. Will initialize.	Servicing required. The backup battery may be flat.	–
906	Fan stopped; Turn off the power immediately.	Turn OFF the power immediately. Servicing required.	–
907	Backup battery is flat.	Servicing is required for battery replacement.	–
912	Fatal error in the communication driver.	Servicing required.	–

#### **Note**

If servicing is required, initialize the instrument once for confirmation.

# 16.3 Performing a Self-Test

## Procedure

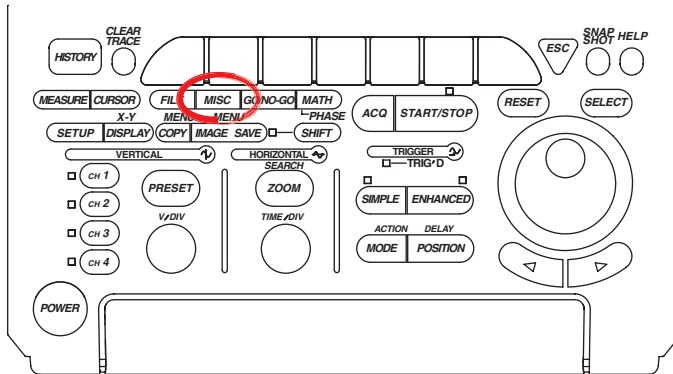

- To exit the menu during operation, press **ESC** located above the soft keys.
- For a description of the operation using a USB keyboard or a USB mouse, see section 4.3.

### Displaying the Self Test Menu

1. Press the **MISC**. The MISC menu appears.
2. Press the **Next (1/2)** soft key. The page 2 menu appears.

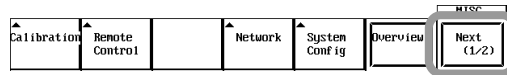

3. Press the **Selftest** soft key. The Self Test menu appears.



### Executing Accuracy Tests of the Memory, Floppy Disk Drive, PC Card, and Printer

4. Press the **Test Item** soft key. The Test Item menu appears.

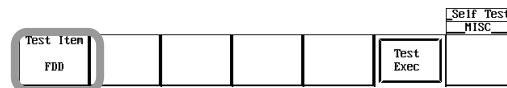

5. Press the **Memory, FDD (or PC CARD)\*, Printer, or Accuracy** soft key to select the test item.

\* Included on certain models only.

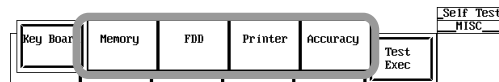

6. Press the **Test Exec** soft key. The Test of the selected item is executed.

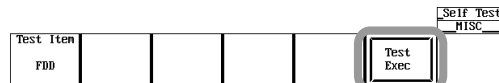



**Executing the Key Test**

4. Press the **Test Item** soft key. The Test Item menu appears.

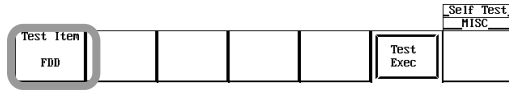

5. Press the **Key Board** soft key. The Key Board menu appears.

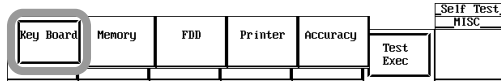

6. Press the **Test Exec** soft key. The Key Board Test window appears.

7. When you press a panel key, the character of the same key name is highlighted in the Key Board Test window.

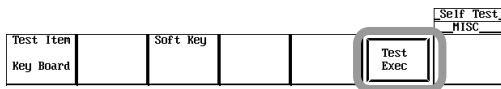

8. Press all panel keys or press **ESC** twice. The key test is terminated.

• **Testing the Soft Keys**

9. Press the **Soft Key** soft key. A keyboard used to enter values and strings appears.

10. Use **jog shuttle & SELECT** or soft keys to check that all the characters on the keyboard can be entered correctly.

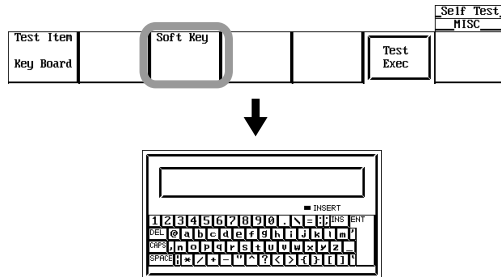

11. Press **ESC**. The keyboard used to enter values and strings clears.

**Note**

- When performing a self test on the floppy disk drive or PC card, insert a floppy disk or PC card into the drive before executing the test.
- Perform the PC card self-test in a condition in which partitions are not used.

**Explanation****Memory Test**

Tests whether the internal ROM and the built-in backup lithium battery is operating correctly. If "Pass" is displayed, it is operating correctly.  
If Failed is displayed, contact your YOKOGAWA dealer.

**Floppy Disk Drive (or PC Card)\* Test**

Tests whether the floppy disk (or PC card) drive is operating properly. If Failed is displayed after executing the test, contact your YOKOGAWA dealer.

\* Included on certain models only.

**Printer Test**

Tests whether the built-in printer is operating properly. If the tint is printed correctly, the operation is normal. If the printer does not print correctly, contact your YOKOGAWA dealer.

**Accuracy Test**

Tests the accuracy of the A/D converter. If Failed is displayed, contact your YOKOGAWA dealer.

**Key Test**

Tests whether the front panel keys are operating properly. If the name of the key being pressed appears highlighted, the key is operating correctly. If it appears in inverse video, contact your YOKOGAWA dealer.

**• Soft Key Test**

Tests whether the soft keys are operating properly. If the characters on the keyboard used to enter values and strings are entered correctly, the soft keys are operating correctly. If the keys do not operate correctly, contact your YOKOGAWA dealer.

## 16.4 Display an Overview of the System Conditions (Overview)

### Procedure

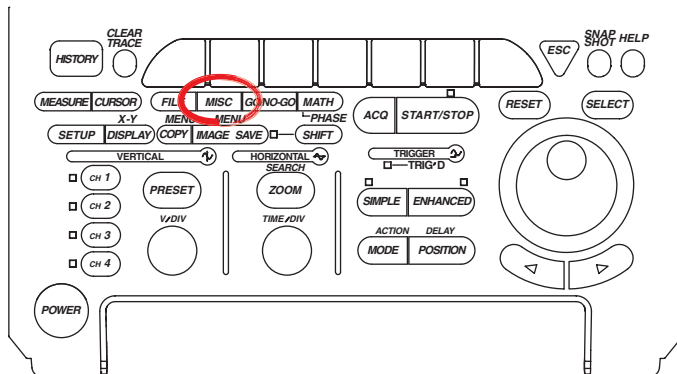

- To exit the menu during operation, press **ESC** located above the soft keys.
- For a description of the operation using a USB keyboard or a USB mouse, see section 4.3.

1. Press the **MISC**. The MISC menu appears.
2. Press the **Overview** soft key. The Overview window opens.

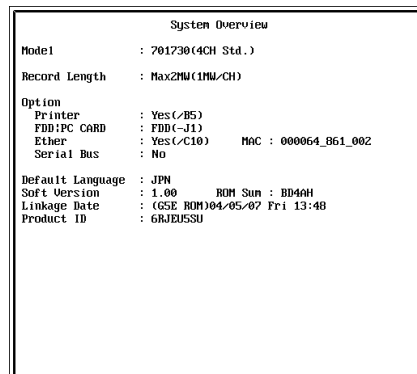
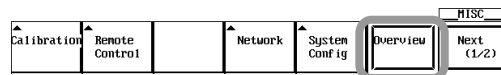

Pressing a panel key other than the Overview soft key clears the Overview window.

### Explanation

You can check the firmware version, model, and installed options on a screen similar to the one shown above.

## 16.5 Replacing the Power Fuse



### WARNING

- To prevent electric shock or fires, use a fuse of the specified rating in terms of current, voltage, and type.
- Always turn OFF the power switch and unplug the power cord before attempting to replace the fuse.
- Do not short the fuse holder.

### Specified Rating

The specifications for power fuses that can be used by the instrument are as follows.

Item	Description
Maximum rated voltage	250 V
Maximum rated current	4 A
Type	Time lag
Standard	VDE/SEMKO/UL/CSA certified.
Part No.	A1352EF

### Exchanging the Fuse

Replace the power fuse according to the following steps.

1. Turn OFF the main power switch on the rear panel.
2. Unplug the power cord from the power connector.
3. Insert the tip of a flathead screwdriver into the indentation on the fuse holder located on the rear panel. Turn the fuse holder and remove it.
4. Remove the blown fuse from the tip of the fuse holder.
5. Insert a new fuse into the fuse holder, then return the fuse holder to its original location on the instrument.

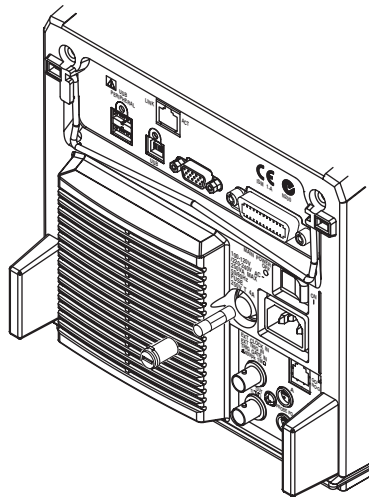

---

## 16.6 Recommended Replacement Parts

The three-year warranty applies only to the main unit of the instrument (starting from the day of delivery) and does not cover any other items nor expendable items (items which wear out). Contact your nearest YOKOGAWA dealer for replacement parts.

<b>Parts Name</b>	<b>Replacement Period</b>
Built-in printer	Under normal usage, 120 rolls of paper (part no.: B9850NX)
LCD backlight	Approx. 25000 hours under normal use

The following items are expendable items. It is recommended that the parts be replaced according to the period indicated below. Contact your nearest YOKOGAWA dealer for replacement parts.

<b>Parts Name</b>	<b>Recommended Replacement Period</b>
Cooling fan	3 years
Backup battery (lithium battery)	5 years

## 17.1 Input Section

Item	Description
Number of input channels	4(CH1-CH4), DL1720E is 2 (CH1, CH2)
Input coupling	AC 1M $\Omega$ , DC 1M $\Omega$ , DC 50 $\Omega$ , GND
Input connector	BNC connector
Input impedance	1 M $\Omega$ $\pm$ 1.0%, approx. 20 pF 50 $\Omega$ $\pm$ 1.0% (VSWR1.4 or less (DC-500 MHz))
Voltage-axis sensitivity setting	For 1 M $\Omega$ input: 2 mV/div to 10 V/div (1-2-5 steps) For 50 $\Omega$ input: 2 mV/div to 1 V/div (1-2-5 steps)
Maximum input voltage	For 1 M $\Omega$ input (at a frequency of 1 kHz or less): 400 V (DC+ACpeak) (282 Vrms CAT II) For 50 $\Omega$ input: 5 Vrms or 10 Vpeak (not to exceed either of the two values)
Maximum DC offset setting range (When the probe attenuation is set to 1:1)	2 mV/div to 50 mV/div: $\pm$ 1 V 100 mV/div-500 mV/div: $\pm$ 10 V 1 V/div-10 V/div: $\pm$ 100 V
Vertical (voltage) axis accuracy	
DC accuracy <sup>1</sup> :	$\pm$ (1.5% of 8 div + offset voltage axis accuracy)
Offset voltage axis accuracy <sup>1</sup>	2 mV/div to 50 mV/div: $\pm$ (1% of the setting + 0.2 mV) 100 mV/div-500 mV/div: $\pm$ (1% of the setting + 2 mV) 1 V/div-10 V/div: $\pm$ (1% of the setting + 20 mV)
Frequency characteristics <sup>1,2</sup> (-3 dB point when a sine wave of amplitude $\pm$ 4 divisions is input)	
For 50 $\Omega$ input	1 V/div-10 mV/div: DC-500 MHz 5 mV/div-2 mV/div: DC-400 MHz
For 1 M $\Omega$ input (when measuring from the probe tip of the 700988 passive probe)	10 V/div-10 mV/div: DC-400 MHz 5 mV/div-2 mV/div: DC-300 MHz
Lower -3 dB attenuation point when AC coupled	10 Hz or less (1 Hz or less when using the 10:1 probe provided)
Skew between channels (When using the same settings)	1 ns or less
Residual noise level <sup>3</sup>	$\pm$ 1.25 mV or $\pm$ 0.15 div, whichever is greater (typical value <sup>4</sup> )
Isolation between channels (same voltage sensitivity)	At 500 MHz: -34 dB (typical value <sup>4</sup> )
A/D conversion resolution	8 bit (24 LSB/div)
Probe attenuation setting	1:1, 10:1, 100:1, 1000:1, 10A:1 V <sup>5</sup> , 100A:1 V <sup>5</sup>
Bandwidth limit	Turn ON/OFF the 100-MHz or 20-MHz bandwidth limit for each channel.
Maximum sample rate	Realtime sampling mode When interleave is ON: 1 GS/s When interleave mode is OFF: 500 MS/s Repetitive Sampling Mode 100 GS/s
Maximum record length	DL1740E: When interleave is ON: 2 MW/CH When interleave mode is OFF: 1 MW/CH DL1740EL: When interleave is ON: 8 MW/CH When interleave mode is OFF: 4 MW/CH DL1720E: When interleave is ON: 1 MW/CH When interleave mode is OFF: 500 kWord/CH

1. Value measured under standard operating conditions (see section 17.12) after thirty-minute warm-up and after calibration with the time base set to internal clock.

2. Value in the case of a repetitive phenomenon.

The frequency bandwidth of a single-shot phenomenon is the smaller of the two values, DC to sampling frequency/2.5 and the frequency bandwidth of a repetitive phenomenon.

3. When the input section is shorted, the record length set to 10 kW, the acquisition mode set to normal mode, the accumulation set to OFF, and the probe attenuation set to 1:1.

4. Typical value represents a typical or average value. It is not strictly warranted.

5. Automatically set to the optimum values for the current probe 700937, 701930, 701931, or 701932 (sold separately).

## 17.2 Trigger Section

Item	Description
Trigger mode	Auto, auto-level, normal, single, and single(N)
Trigger source	CH1 to CH4 <sup>1</sup> (signal input from each input terminal), LINE (commercial power supply signal that is connected), EXT (signal input from the EXT TRIG IN terminal (or the EXT terminal on the DL1720E)).
Trigger coupling	CH1-CH4 <sup>1</sup> : DC/AC EXT: DC
HF rejection	Select the bandwidth limit with respect to the trigger source (OFF/DC to approx. 15 kHz or DC to approx. 20 MHz) for each channel (CH1 to CH4 <sup>1</sup> )
Trigger hysteresis	Select high or low for the trigger level hysteresis width for each channel (CH1 to CH4 <sup>1</sup> )
Trigger level range	CH1-CH4 <sup>1</sup> : 4 divisions from the screen center. EXT: $\pm 2$ V (DL1740E/DL1740EL) $\pm 1$ V (when the $\pm 1$ V range set on the DL1720E) $\pm 10$ V (when the $\pm 10$ V range set on the DL1720E)
Trigger level setting resolution	CH1-CH4 <sup>1</sup> : 0.01div EXT: 5 mV (DL1740E/DL1740EL) 5 mV (when the $\pm 1$ V range set on the DL1720E) 50 mV (when the $\pm 10$ V range set on the DL1720E)
Trigger level accuracy	CH1-CH4 <sup>1,2</sup> : $\pm$ (one division + 10% of the trigger level) EXT <sup>3</sup> : $\pm$ (50 mV + 10% of the trigger level) (DL1740E/DL1740EL) $\pm$ (50 mV + 10% of the trigger level) ( $\pm 1$ V range of the DL1720) $\pm$ (500 mV + 10% of the trigger level) ( $\pm 10$ V range of the DL1720)
Probe attenuation setting for external trigger	1:1/10:1
Trigger sensitivity <sup>2</sup>	CH1-CH4 <sup>1</sup> : For DC-500 MHz, 1divP-P EXT: DC to 100 MHz 100 mVP-P (DL1740E/DL1740EL) DC to 100 MHz 100 mVP-P ( $\pm 1$ V range of the DL1720E) DC to 100 MHz 1 VP-P ( $\pm 10$ V range of the DL1720E)
Trigger position	Can be set in 1% increments of the display record length.
Trigger delay range	0 to 4 s
Hold off time range	80 ns to 10 s
Trigger slope	Rising, falling, rising and falling (for edge trigger)
Trigger type	Edge: Activate the trigger on the edge of a single trigger source. A->B(N): Trigger occurs nth time condition B becomes true after condition A becomes true. Count: 1-10 <sup>8</sup> Condition A: Enter/Exit OR: Condition B: Enter/Exit OR: A Delay B: Trigger occurs first time condition B becomes true after specified delay following condition A true. Specified time: 3 ns to 5 s Condition A: Enter/Exit OR: Condition B: Enter/Exit OR: OR: Trigger occurs on the OR logic of the trigger conditions set to multiple trigger sources. Trigger conditions are Edge and Window, and Rise (IN), Fall (Out), or Don't Care can be set to each channel CH1 to CH4 <sup>1</sup> . Pattern: Trigger occurs on the edge of the clock channel with respect to the True/False condition of the parallel pattern set to multiple trigger sources. If the clock channel is set to Don't Care, trigger occurs on the Enter or Exit condition of the True/False condition of the parallel pattern. Parallel pattern is the AND of the state of each channel.

Item	Description
	<p>Pulse Width: Trigger occurs on the True/False width of the parallel pattern of multiple trigger sources. Parallel pattern is the AND of the status of the channels or the AND of the window conditions of the channels.</p> <p>Pulse&gt;Time: Trigger occurs when the width described above is greater than Time.</p> <p>Pulse&lt;Time: Trigger occurs when the width described above is smaller than Time.</p> <p>T1&lt;Pulse&lt;T2: Trigger occurs when the width described above is greater than T1 and smaller than T2.</p> <p>Time Out: Trigger occurs when the width described exceeds Time.</p> <p>Specified time: 1 ns to 1 s</p> <p>Time accuracy<sup>2</sup>: <math>\pm (0.5\% \text{ of the setting}^4 + 1 \text{ ns})</math></p> <p>Minimum time detection width: 2 ns (typical value<sup>5</sup>)</p> <p>TV: Activates a trigger on the video signal of various formats: NTSC, PAL, SECAM, 1080/60i, 1080/50i, 720/60p, 480/60p, 1080/25p, 1080/24p, 1080/24sF, and 1080/60p CH1 is the only input channel. Field number and line number selectable.</p> <ul style="list-style-type: none"> <li>Condition A and Condition B are parallel patterns set using High, Low, and Don't Care on each channel CH1 to CH4<sup>1</sup>.</li> </ul>
Trigger gate	<p>Trigger can be activated only when the trigger condition is met when the input from the trigger gate input terminal (TRIG GATE IN) is active.</p> <p>Active level can be set to high or low.</p>

1. Or CH1 and CH2 on the DL1720E

2. Under standard operating conditions (see section 17.11) after the warm-up and calibration. have been performed.

3. Under standard operating conditions (see section 17.11) after the warm-up.

4. The setting for T1<Pulse<T2 is the T2 value.

5. Typical value represents a typical or average value. It is not strictly warranted.

## 17.3 Time Axis

Item	Description
Time axis range	<p>1 ns/div to 50 s/div (when the record length is greater than or equal to 10 kW)</p> <p>1 ns/div to 5 s/div (when the record length is equal to 1 kW)</p>
Time base accuracy <sup>1</sup>	$\pm(0.005\%)$
Time axis precision <sup>1</sup>	$\pm(0.005\%+50\text{ps}+1 \text{ digit})^2$ .
External clock input <sup>3</sup>	<p>Connector type: BNC</p> <p>Maximum input voltage: <math>\pm 40 \text{ V (DC+ACpeak)}</math> or 28 Vrms when the frequency is 10 kHz or less</p> <p>Input frequency range: 40 Hz to 20 MHz (continuous clock only)</p> <p>Sampling jitter: <math>\pm 1.25 \text{ ns}</math> or less</p> <p>Minimum input amplitude: 0.1 VP-P (DL1740E/DL1740EL)</p> <p>0.1 VP-P (when the <math>\pm 1 \text{ V}</math> range set on the DL1720E)</p> <p>1 VP-P (when the <math>\pm 10 \text{ V}</math> range set on the DL1720E)</p> <p>Threshold level: <math>\pm 2 \text{ V}</math>, setting resolution is 5 mV (on the DL1740E/DL1740EL)</p> <p><math>\pm 1 \text{ V}</math>, setting resolution: 5 mV (when the <math>\pm 1 \text{ V}</math> range set on the DL1720E)</p> <p><math>\pm 10 \text{ V}</math>, setting resolution: 50 mV (when the <math>\pm 10 \text{ V}</math> range set on the DL1720E)</p> <p>Input impedance: Approximately 1 M<math>\Omega</math> and approximately 20 pF</p> <p>Minimum pulse width: 10 ns or more for High and Low.</p>

1. Under standard operating conditions (see section 17.11) after the warm-up.

2. 1 digit is the amount that cannot be determined due to sampling error.

3. On the DL1740E/DL1740EL, the terminals are EXT CLOCK IN/EXT TRIG IN/TRIG GATE IN, and on the DL1720E it is labeled EXT.



## 17.4 Display

Item	Description
Display	6.4" color TFT LCD monitor
Display screen size	130.6 mm (width) × 97.0 mm (height)
Total number of pixels*	640 × 480
Display resolution of the waveform display	500 × 384

\* Liquid crystal display may include a few defective pixels (within 40 ppm with respect to the total number of pixels including RGB).

There may be few pixels on the liquid crystal display that do not turn ON all the time, or that remain ON all the time. This is not an indication of a defective product.

## 17.5 Functions

### Acquisition and Display

Item	Description
Acquisition mode	Select from four acquisition modes: normal, envelope, averaging, and box average.
Sampling mode	Switch between realtime sampling and repetitive sampling at some of the time axis settings.
Record length	DL1740E: Select from 1 kWord, 10 kWord, 50 kWord, 100 kWord, 250 kWord, 500 kWord, 1 MWord, 2 MWord DL1740EL: Select from 1 kWord, 10 kWord, 50 kWord, 100 kWord, 250 kWord, 500 kWord, 1 MWord, 2 MWord, 4 MWord, 8 MWord DL1720E: Select from 1 kWord, 10 kWord, 50 kWord, 100 kWord, 250 kWord, 500 kWord, 1 MWord
Zoom	Expand the displayed waveform along the time axis (up two locations using separate zoom rates)
Display format	Split display of analog waveforms (1, 2, 3, 4, and 6 windows (1, 2, and 3 windows on the DL1720E)).
Display interpolation	Select interpolation OFF (dot display of sample points), sine interpolation display, linear interpolation display, or pulse interpolation display.
Graticule	Select from three graticule types.
Auxiliary display ON/OFF	Turn ON/OFF the scaled values and waveform labels.
X-Y display	Two X-Y waveform displays are available, XY1 and XY2 (only XY1 is available on the DL1720E).
Accumulation	Accumulates waveforms on the display. Select persistence mode or color grade mode.
Snapshot	Retains the current displayed waveform on the screen. Snapshot waveforms can be saved and loaded.
Clearing traces	Clears the displayed waveform.

### Vertical/Horizontal Axis Setting

Item	Description
Channel ON/OFF	ON/OFF on each channel CH1 to CH4*
Input filter	Set 100-MHz or 20-MHz bandwidth limit on each channel CH1 to CH4*.
Vertical position setting	Waveforms can be moved vertically in the range of $\pm 4$ div from the center of the waveform display frame.
Linear scaling	Set the scaling factor, offset value, and unit on each channel CH1 to CH4*.
Roll mode	Roll mode display is enabled when the trigger mode is set to auto, auto level, or single at the following time axis settings. 1 MW or less: 50 ms/div to 50 s/div (except 50 ms to 5 s/div for 1kW) 2 MW or less: 100ms/div–50s/div 4 MW or less: 200ms/div–50s/div 8 MW or less: 500ms/div–50s/div

\* Or CH1 and CH2 on the DL1720E

## Computation, Analysis, and Search

Item	Description
Computation	+ , - , × , binary computation, invert, differentiation, integration, and power spectrum. The maximum record length that can be computed is as follows: DL1740E, DL1720E: All record lengths. DL1740EL           When interleave is ON:           4 MWord When interleave mode is OFF: 2 MWord However, select the range (1 kW or 10 kW) for power spectrum computation (FFT).
Phase shift	You can shift the phase on CH1 to CH4 <sup>1</sup> and observe the resultant signals. Computation is performed using the phase shifted results.
History search function	Search for and display waveforms from the history memory that meet specified conditions. Select the search method from the following two types. Zone:           Set an area on the screen, then extract and display only those waveforms that pass through the area (Pass mode), or do not pass through the area (Bypass mode). Parameter: Extract and display only the results of the automated measurement of waveform parameters that meet the specified condition.
Search and zoom function	Search a section of the displayed waveform data and display the section expanded. Select the search method from the following five types. Edge:           Counts the rising and falling edges and automatically searches an arbitrary edge. Serial pattern: Automatically searches serial patterns of up to 64 bits synchronized or not synchronized to the clock. Parallel pattern: Automatic parallel pattern search on CH1 to CH4, Math1 and Math2 (or CH1, CH2, and Math1 on the DL1720E). Pulse width:   Automatically searches the locations where the pulse width meets the specified condition. Auto scroll:    The zoom position can be automatically scrolled.
Cursor measurements	The following cursors are selectable. Horizontal, Vertical, Marker, and Degree
Automated measurement of waveform parameters	Capable of performing automated measurement of waveform parameters. Automated measurement of waveform parameters within one cycle (P-P through Int2XY), statistical processing of waveform parameters, and statistical processing on the waveform parameters of historical data. P-P, Max, Min, Ave, Rms, Sdev, High, Low, +OShot, -OShot, Int1TY, Int2TY, Int1XY, Int2XY, Freq, Period, Rise, Fall, +Width, -Width, Duty, Burst1, Burst2, Pulse, AvgFreq, AvgPeriod, and Delay (between channels) Statistical processing results Statistical items           Min, Max, Avg, Cnt, and Sdv Measurement of waveform parameters in dual areas is also possible. Computation can be performed between waveform parameters measured in dual areas and constants. Operator: +, -, *, or /
GO/NO-GO determination	The following two types of GO/NO-GO determination are available <ul style="list-style-type: none"> <li>• Determination using zones on the screen</li> <li>• Determination using the result of the automated measurement of waveform parameters</li> </ul> Specify an action for NO-GO result. Possible actions are screen image data output, waveform data storage, buzzer notification, and e-mail transmission <sup>2</sup> .

1. Or CH1 and CH2 on the DL1720E

2. When the Ethernet interface option is installed

## Saving and Printing of the Screen Image Data

Item	Description
Built-in printer (optional)	Prints screen image data.
External printer	Outputs the screen image to an external printer via the USB PERIPHERAL terminal or the Ethernet network <sup>1</sup> . Supports page description languages and printer types such as ESC/P, ESC/P2, LIPS3, PCL5, Post Script (only via the Ethernet network <sup>1</sup> ), and BJ
Floppy disk <sup>2</sup> or PC card, network drive <sup>1</sup> , USB storage	Output data format: PostScript, TIFF, BMP, JPEG, and PNG

1. When the Ethernet interface option is installed

2. Select floppy disk drive or PC card interface for the built-in media drive.

## 17.5 Functions

### Data Storage

Item	Description
History memory	When interleave is ON: Automatically save up to 2048 acquisition data points. When interleave mode is OFF: Automatically save up to 1024 acquisition data points.
Floppy disk <sup>1</sup> or PC card, network drive <sup>2</sup> , USB storage	Saves setup data, waveform data, and various data

1. Select floppy disk drive or PC card interface for the built-in media drive.
2. When the Ethernet interface option is installed

### Other

Item	Description
Initialization	Resets settings to the factory default (excluding date/time setting, communication interface settings, settings stored to the internal memory using the store/recall function, and language setting)
Auto setup	Automatically sets the optimum voltage axis, time axis, trigger, and other settings for the input signal.
Store/Recall	Store and recall up to three sets of arbitrary setup data to and from the instrument's internal memory.
Preset	Presets for CMOS (5 V), CMOS (3.3 V), ECL, and user settings.
Action-on-trigger	Outputs screen image data, saves waveform data, activates buzzer notification, or sends email messages each time a trigger occurs.
Mail transmission*	Periodically sends the status of the instrument to a specified mail address via the Ethernet network. Can also send information as an action for GO/NO-GO determination and action on-trigger.
Calibration	Auto calibration and manual calibration available.
Deskew	Corrects the delay of the acquired waveforms on each channel. Adjustment range is $\pm 100$ ns (0.01 ns resolution)
Environment settings	Set the screen color, date/time, message language, and click sound ON/OFF
Probe compensation signal output	Outputs a signal (rectangular signal of approx. 1 V <sub>p-p</sub> and approx. 1 kHz) from the probe compensation output terminal on the front panel
Overview	Check the system status of the instrument.
Self test	Memory test, key test, printer test, floppy disk drive test, PC card test, and accuracy test are possible.
Menu language setting	Menus can be displayed in English or Chinese.
HelpDisplays	help concerning the settings (select Chinese, English, or Japanese)
Thumbnail	Shows thumbnails of the screen image data

\* When the Ethernet interface option is installed

## 17.6 Built-in Printer (Optional)

Item	Description
Printing system	Thermal line dot system
Dot density	8 dots/mm
Paper width	112mm

## 17.7 Storage

### Built-in Storage\*

#### • Floppy Disk Drive

Item	Description
Number of drives	1
Size	3.5 inch
Capacity	1.44MB

#### • PC Card Interface

Item	Description
Number of slots	1
Supported cards	Flash ATA card (PC card TYPE II)

\* You can select a built-in storage device of floppy disk drive or PC card interface.

### USB Storage

Item	Description
Supports USB mass storage	USB mass storage class hard disk drive, MO disk drive, and flash memory

For detailed specifications, see USB PERIPHERAL interface in the next section.

## 17.8 USB Peripheral Interface

Item	Description
Connector type	USB type A connector (receptacle)
Electrical and mechanical	USB Rev. 1.1
Data rate	12 Mbps max.
Supported keyboards	104 keyboard (US), 109 keyboard (Japanese), and 89 keyboard (US and Japanese) conforming to USB HID Class Version 1.1
Supported printers	ESC/P, ESC/P2, LIPS3, PCL5, and BJ (can be used on models that support the BJC-35 V native commands) that support USB (USB Printer Class Version 1.0)
Supported mouse	Mouse conforming to USB HID Class Version 1.1
Supports USB mass storage	USB mass storage class hard disk drive, MO disk drive, and flash memory
Power supply	5 V, 500 mA* (per port)
Number of ports	2

\* Devices with maximum consumption currents exceeding 100 mA cannot be connected to two ports at the same time.

## 17.9 Auxiliary I/O Section

### External Trigger Input<sup>1</sup> and Trigger Gate Input<sup>1</sup>

Item	Description
Connector type	BNC
Input bandwidth <sup>2</sup>	DC to 100 MHz <sup>3</sup>
Input impedance	Approximately 1 M $\Omega$ and approximately 20 pF
Maximum input voltage	$\pm 40$ V (DC+ACpeak) or 28 Vrms when the frequency is 10 kHz or less.
Trigger level	$\pm 2$ V, setting resolution is 5 mV (on the DL1740E/DL1740EL) $\pm 1$ V, setting resolution: 5 mV (when the $\pm 1$ V range set on the DL1720E) $\pm 10$ V, setting resolution: 50 mV (when the $\pm 10$ V range set on the DL1720E)

1. The external trigger input terminal and trigger gate input terminal are also used as external clock input terminals. (On the DL1740E/DL1740EL, the terminals are EXT CLOCK IN/EXT TRIG IN/TRIG GATE IN, and on the DL1720E it is labeled EXT.) See the specifications of the external clock input (see section 17.3).
2. Under standard operating conditions (see section 17.11) after the warm-up.
3. The input frequency range when using the terminal as a trigger gate input is DC to 50 MHz.

### Trigger Output (TRIG OUT)

Item	Description
Connector type	BNC
Output level	TTL
Output logic	$\overline{1}$ (Negative)
Output delay time	50 ns max
Output hold time	1 $\mu$ s minimum for low level and 100 ns minimum for high level

### RGB Video Signal Output (RGB VIDEO OUT)

Item	Description
Connector type	15-pin D-Sub receptacle
Output type	VGA compatible

### GO/NO-GO Determination Output (NO-GO OUT, GO OUT)

Item	Description
Connector type	RJ-12 modular jack
Output type	TTL compatible
Signal	GO-OUT/NOGO-OUT
Compatible cable	4-wire modular cable

### Probe Power Supply Terminal (Optional)

Item	Description
Number of output terminals	DL1740E/DL1740EL: 4 (A to D) DL1720E: 2 (A,B)
Output voltage	+12 V (Up to $\pm 400$ mA on pairs of terminals A and C, and B and D. $\pm 600$ mA total on A thru D).
Probes that can be used	FET probe (700939), current probe (700937, 701930, 701931, 701932), and differential probe (701920 or 701922)

## 17.10 Computer Interface

### GP-IB

Item	Description
Electrical and mechanical	Conforms to IEEE St'd 488-1978 (JIS C 1901-1987).
Functional specifications	SH1, AH1, T6, L4, SR1, RL1, PP0, DC1, DT0, and C0
Protocol	Conforms to IEEE St'd 488.2-1987.
Code	ISO (ASCII) code
Mode	Addressable mode
Address	Specify a talker/listener address between 0 and 30.
Clear remote mode	Remote mode can be cleared using the SHIFT+CLEAR TRACE key (except during Local Lockout).

For details, see the Communication Interface User's Manual (IM701710-17E).

### USB

Item	Description
Connector type	USB type B connector (receptacle)
Electrical and mechanical	USB Rev. 1.1
Data rate	12 Mbps max.
Number of ports	1
PC system supported	PC running Windows 98 SE, Windows Me, Windows 2000, or Windows XP with a standard USB port (a separate driver is needed to connect to a PC).

### Ethernet (Optional)

Item	Description
Number of communication ports	1
Electrical and mechanical specifications	Conforms to IEEE802.3
Transmission system	Ethernet (100BASE-TX/10BASE-T)
Transmission rate	100 Mbps max.
Communication protocol	TCP/IP
Supported services	FTP server, FTP client (network drive), LPR client (network printer), SMTP client (mail transmission), Web server, DHCP, DNS, SNMP, and WebDAV
Connector type	RJ-45 connector

## 17.11 General Specifications

Item	Description
Standard operating conditions	Ambient temperature: 23±2°C Ambient humidity: 55±10% RH Error in supply voltage and frequency: Within 1% of rating
Warm-up time	At least thirty minutes
Storage conditions	Temperature: -20-60°C Humidity: 20 to 80% RH (no condensation)
Operating Conditions	Temperature: 5-40°C Humidity: 20 to 80% RH (when the printer is not used) 35 to 80% RH (when the printer is used) } <b>However, no condensation may be present</b>
Storage altitude	3,000m or less
Operating altitude	2000 m or less
Rated supply voltage	100 to 120 VAC/220 to 240 VAC
Permitted supply voltage range	90 to 132 VAC/198 to 264 VAC
Rated supply voltage frequency	50/60 Hz
Permitted supply voltage frequency range	48 to 63 Hz
Power fuse	250 V 4 A time lag, VDE/SEMKO/UL/CSA certified.
Maximum power consumption	200 VA (when using the printer)
Withstanding voltage (between power supply and case)	1.5 kVAC for one minute.
Insulation resistance (between power supply and case)	500 VDC, 10 MΩ or more at
External dimensions (details on the next page)	220mm (W) × 265.8mm (H) × 264.1mm (D) (When printer cover stored, excluding projections).
Weight (No options)	DL1740E/DL1740EL: Approximately 5.4kg. DL1720E: Approximately 5.2kg.
Instrument's cooling method	Forced air cooling, exhaust from rear.
Installation position	Horizontal (note that the stand can be used to tilt the instrument) or vertical, stacking prohibited.
Recommended calibration period	1 year
Battery backup	Setup data and clock are backed up with the internal lithium battery Battery life: Approx. 5 years (at ambient temperature of 23°C )
Accessories	Power cord: 1 400 MHz passive probe (DL1740E/DL1740EL) 4 (DL1720E) 2 Power fuse A1352EF, 1 Probe case B9918EZ, 1 Front panel protection cover B9989FA, 1 Roll paper for printer 1 roll (with specification code /B5) Rubber Feet B9989EX, 1 (4 pcs.) User's Manual 1, this document Operation guide 1 Communications interface manual 1 (CD-ROM)

Item	Description	
Safety Standards	Standards Compliance	EN61010-1 <ul style="list-style-type: none"> <li>• Overvoltage category II<sup>1</sup></li> <li>• Pollution degree<sup>2</sup></li> </ul>
Emission	Standards Compliance	<ul style="list-style-type: none"> <li>• EN61326 Class A, C-Tick AS/NZS 2064 (applies to 701715, 701730, 701740, 700988, and 700939)</li> <li>• EN61000-3-2</li> <li>• EN61000-3-3</li> <li>• This product is a Class A (for commercial environment) product. Operation of this product in a residential area may cause radio interference in which case the user is required to correct the interference.</li> </ul>
	Cable condition	<ul style="list-style-type: none"> <li>• Also used as an external trigger/external clock/trigger gate input terminal Use a BNC cable<sup>3</sup> and attach a ferrite core (TDK: ZCAT2035-0930A, YOKOGAWA: A1190MN) on one end (instrument end).</li> <li>• Trigger output terminal Same as the external trigger input terminal above.</li> <li>• Video signal output (VIDEO OUT (VGA)) terminal Use a 15-pin D-Sub VGA shielded cable<sup>3</sup>.</li> <li>• USB peripheral connector Attach a ferrite core (TDK: ZCAT1325-0530A, YOKOGAWA: A1181MN) on one end (instrument end) of a USB cable<sup>3</sup>.</li> <li>• USB interface connector Attach a ferrite core (TDK: ZCAT1325-0530A, YOKOGAWA: A1181MN) on one end (instrument end) of a USB cable<sup>3</sup>.</li> <li>• GO/NO-GO output terminal Use a GO/NO-GO cable (sold separately, YOKOGAWA part no. 366973), and attach a ferrite core (TDK: ZCAT1325-0530A, YOKOGAWA: A1181MN) on one end (instrument end) of the cable.</li> <li>• Ethernet connector Use an Ethernet cable<sup>3</sup>, and attach a ferrite core (TDK: ZCAT1325-0530A, YOKOGAWA: A1181MN) on one end (instrument end) of the cable.</li> <li>• Probe power terminal Attach a ferrite core (TDK: ZCAT1325-0530A, YOKOGAWA: A1181MN) on one end (instrument end) of the cable.</li> </ul>
Immunity	Standards Compliance	EN61326 commercial environment (applies to 701715, 701730, 701740, 700988, and 70939)
	Influence in the immunity environment	<ul style="list-style-type: none"> <li>• Noise increase: <math>\leq \pm 80</math> mV (when using 700988) <math>\leq \pm 400</math> mV (when using 700939)</li> <li>• Test conditions When using the 700988: 500 MS/s, envelope mode, 20 MHz BWL, 1 M<math>\Omega</math> input coupling, 20 mV/div (10:1 probe attenuation setting), and 50 <math>\Omega</math> termination at the probe tip. When using the 700939: 500 MS/s, envelope mode, 20 MHz BWL, 50 <math>\Omega</math> input coupling, 100 mV/div (10:1 probe attenuation setting), and 50 <math>\Omega</math> termination at the probe tip.</li> <li>• Cable condition Same as the cable condition for emission above.</li> </ul>

1. The Overvoltage Category (Installation Category) is a value used to define the transient overvoltage condition and includes the impulse withstand voltage regulation. II applies to electrical equipment that is powered by a fixed installation such as a distribution board.
2. Pollution Degree applies to the degree of adhesion of a solid, liquid, or gas which deteriorates withstand voltage or surface resistivity. Pollution Degree 2 applies to normal indoor atmospheres (with only non-conductive pollution).
3. Use cables of length 3m or less.



## 17.12 Dimensional Drawings

Unit: mm

### Rear Panel

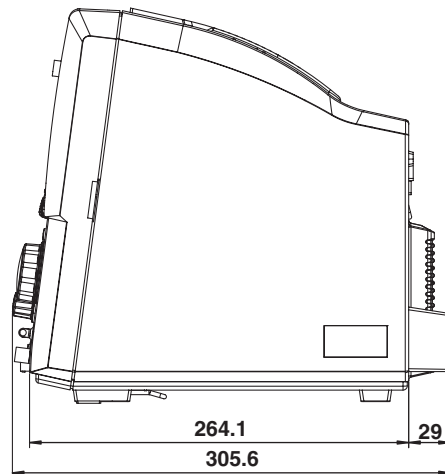
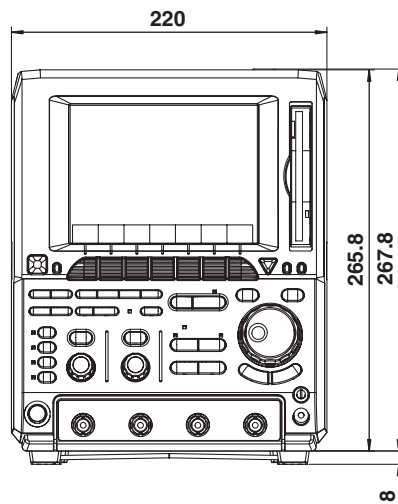
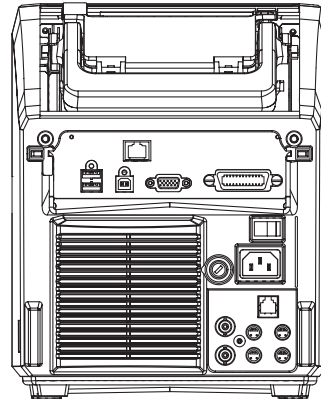
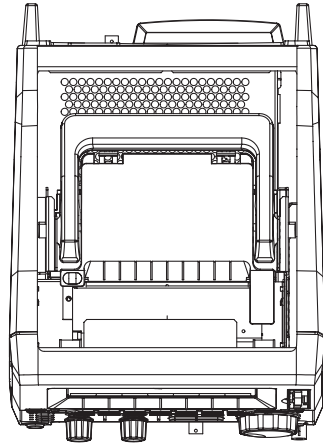

Tolerance is  $\pm 3\%$  (however, in cases of less than 10 mm, the tolerance is  $\pm 0.3$  mm).

# Appendix 1 Relationship between the Time Axis Setting, Sample Rate and Record Length

Specified Record Length: 1 kW

Rep: Repetitive sampling mode

Setting  T/div	When set to a mode other than envelope mode								When set to envelope mode			
	When interleave mode is OFF				When interleave mode is ON				When interleave mode is OFF		When interleave mode is ON	
	Rep: OFF		Rep: ON		Rep: OFF		Rep: ON		Sample rate (S/s)	Display record length (Word)	Sample rate (S/s)	Display record length (Word)
	Sample rate (S/s)	Display record length (Word)	Sample rate (S/s)	Display record length (Word)	Sample rate (S/s)	Display record length (Word)	Sample rate (S/s)	Display record length (Word)	Sample rate (S/s)	Display record length (Word)	Sample rate (S/s)	Display record length (Word)
50 s	These time axis settings are not possible when the record length is 1 kW.											
20 s												
10 s												
5 s	20	1 k	20	1 k	20	1 k	20	1 k	400 M	1 k	800 M	1 k
2 s	50	1 k	50	1 k	50	1 k	50	1 k	400 M	1 k	800 M	1 k
1 s	100	1 k	100	1 k	100	1 k	100	1 k	400 M	1 k	800 M	1 k
500 ms	200	1 k	200	1 k	200	1 k	200	1 k	400 M	1 k	800 M	1 k
200 ms	500	1 k	500	1 k	500	1 k	500	1 k	400 M	1 k	800 M	1 k
100 ms	1 k	1 k	1 k	1 k	1 k	1 k	1 k	1 k	400 M	1 k	800 M	1 k
50 ms	2 k	1 k	2 k	1 k	2 k	1 k	2 k	1 k	400 M	1 k	800 M	1 k
20 ms	5 k	1 k	5 k	1 k	5 k	1 k	5 k	1 k	400 M	1 k	800 M	1 k
10 ms	10 k	1 k	10 k	1 k	10 k	1 k	10 k	1 k	400 M	1 k	800 M	1 k
5 ms	20 k	1 k	20 k	1 k	20 k	1 k	20 k	1 k	400 M	1 k	800 M	1 k
2 ms	50 k	1 k	50 k	1 k	50 k	1 k	50 k	1 k	400 M	1 k	800 M	1 k
1 ms	100 k	1 k	100 k	1 k	100 k	1 k	100 k	1 k	400 M	1 k	800 M	1 k
500 μs	200 k	1 k	200 k	1 k	200 k	1 k	200 k	1 k	400 M	1 k	800 M	1 k
200 μs	500 k	1 k	500 k	1 k	500 k	1 k	500 k	1 k	400 M	1 k	800 M	1 k
100 μs	1 M	1 k	1 M	1 k	1 M	1 k	1 M	1 k	400 M	1 k	800 M	1 k
50 μs	2 M	1 k	2 M	1 k	2 M	1 k	2 M	1 k	400 M	1 k	800 M	1 k
20 μs	5 M	1 k	5 M	1 k	5 M	1 k	5 M	1 k	400 M	1 k	800 M	1 k
10 μs	10 M	1 k	10 M	1 k	10 M	1 k	10 M	1 k	400 M	1 k	800 M	1 k
5 μs	20 M	1 k	20 M	1 k	20 M	1 k	20 M	1 k	400 M	1 k	800 M	1 k
2 μs	50 M	1 k	50 M	1 k	50 M	1 k	50 M	1 k	400 M	1 k	800 M	1 k
1 μs	100 M	1 k	100 M	1 k	100 M	1 k	100 M	1 k	400 M	1 k	800 M	1 k
500 ns	200 M	1 k	200 M	1 k	200 M	1 k	200 M	1 k	400 M	1 k	800 M	1 k
200 ns	500 M	1 k	500 M	1 k	500 M	1 k	500 M	1 k			1 G	1 k
100 ns	500 M	500	1 G	1 k	1 G	1 k	1 G	1 k	Set to normal mode even if envelope mode is specified.			
50 ns	500 M	250	2 G	1 k	1 G	1 k	2 G	1 k				
20 ns	500 M	100	5 G	1 k	1 G	500	5 G	1 k				
10 ns	10 G	1 k	10 G	1 k	2 G	200	10 G	1 k				
5 ns	20 G	1 k	20 G	1 k	10 G	1k	20 G	1 k				
2 ns	50 G	1 k	50 G	1 k	50 G	1k	50 G	1 k				
1 ns	100 G	1 k	100 G	1 k	100 G	1k	100 G	1 k	*			

\* The values inside the thick frame are for repetitive sampling mode.

**Appendix 1 Relationship between the Time Axis Setting, Sample Rate and Record Length**

**Specified Record Length: 10 kW**

**Rep: Repetitive sampling mode**

Setting  T/div	When set to a mode other than envelope mode								When set to envelope mode			
	When interleave mode is OFF				When interleave mode is ON				When interleave mode is OFF		When interleave mode is ON	
	Rep: OFF		Rep: ON		Rep: OFF		Rep: ON		Sample rate (S/s)	Display record length (Word)	Sample rate (S/s)	Display record length (Word)
	Sample rate (S/s)	Display record length (Word)	Sample rate (S/s)	Display record length (Word)	Sample rate (S/s)	Display record length (Word)	Sample rate (S/s)	Display record length (Word)	Sample rate (S/s)	Display record length (Word)	Sample rate (S/s)	Display record length (Word)
50 s	20	10 k	20	10 k	20	10 k	20	10 k	400 M	10 k	800 M	10 k
20 s	50	10 k	50	10 k	50	10 k	50	10 k	400 M	10 k	800 M	10 k
10 s	100	10 k	100	10 k	100	10 k	100	10 k	400 M	10 k	800 M	10 k
5 s	200	10 k	200	10 k	200	10 k	200	10 k	400 M	10 k	800 M	10 k
2 s	500	10 k	500	10 k	500	10 k	500	10 k	400 M	10 k	800 M	10 k
1 s	1 k	10 k	1 k	10 k	1 k	10 k	1 k	10 k	400 M	10 k	800 M	10 k
500 ms	2 k	10 k	2 k	10 k	2 k	10 k	2 k	10 k	400 M	10 k	800 M	10 k
200 ms	5 k	10 k	5 k	10 k	5 k	10 k	5 k	10 k	400 M	10 k	800 M	10 k
100 ms	10 k	10 k	10 k	10 k	10 k	10 k	10 k	10 k	400 M	10 k	800 M	10 k
50 ms	20 k	10 k	20 k	10 k	20 k	10 k	20 k	10 k	400 M	10 k	800 M	10 k
20 ms	50 k	10 k	50 k	10 k	50 k	10 k	50 k	10 k	400 M	10 k	800 M	10 k
10 ms	100 k	10 k	100 k	10 k	100 k	10 k	100 k	10 k	400 M	10 k	800 M	10 k
5 ms	200 k	10 k	200 k	10 k	200 k	10 k	200 k	10 k	400 M	10 k	800 M	10 k
2 ms	500 k	10 k	500 k	10 k	500 k	10 k	500 k	10 k	400 M	10 k	800 M	10 k
1 ms	1 M	10 k	1 M	10 k	1 M	10 k	1 M	10 k	400 M	10 k	800 M	10 k
500 μs	2 M	10 k	2 M	10 k	2 M	10 k	2 M	10 k	400 M	10 k	800 M	10 k
200 μs	5 M	10 k	5 M	10 k	5 M	10 k	5 M	10 k	400 M	10 k	800 M	10 k
100 μs	10 M	10 k	10 M	10 k	10 M	10 k	10 M	10 k	400 M	10 k	800 M	10 k
50 μs	20 M	10 k	20 M	10 k	20 M	10 k	20 M	10 k	400 M	10 k	800 M	10 k
20 μs	50 M	10 k	50 M	10 k	50 M	10 k	50 M	10 k	400 M	10 k	800 M	10 k
10 μs	100 M	10 k	100 M	10 k	100 M	10 k	100 M	10 k	400 M	10 k	800 M	10 k
5 μs	200 M	10 k	200 M	10 k	200 M	10 k	200 M	10 k	400 M	10 k	800 M	10 k
2 μs	500 M	10 k	500 M	10 k	500 M	10 k	500 M	10 k			1 G	10 k
1 μs	500 M	5 k	1 G	10 k	1 G	10 k	1 G	10 k				
500 ns	500 M	2.5 k	2 G	10 k	1 G	5 k	2 G	10 k	* Set to normal mode even if envelope mode is specified.			
200 ns	500 M	1 k	5 G	10 k	1 G	2 k	5 G	10 k				
100 ns	500 M	500	10 G	10 k	1 G	1 k	10 G	10 k				
50 ns	500 M	250	20 G	10 k	1 G	500	20 G	10 k				
20 ns	500 M	100	50 G	10 k	1 G	200	50 G	10 k				
10 ns	500 M	10 k	100 G	10 k	100 G	10 k	100 G	10 k				
5 ns	100 G	5 k	100 G	5 k	100 G	5 k	100 G	5 k				
2 ns	100 G	2 k	100 G	2 k	100 G	2 k	100 G	2 k				
1 ns	100 G	1 k	100 G	1 k	100 G	1 k	100 G	1 k				

\* The values inside the thick frame are for repetitive sampling mode.

## Appendix 1 Relationship between the Time Axis Setting, Sample Rate and Record Length

Specified Record Length: 50 kW

Rep: Repetitive sampling mode

Setting  T/div	When set to a mode other than envelope mode								When set to envelope mode			
	When interleave mode is OFF				When interleave mode is ON				When interleave mode is OFF		When interleave mode is ON	
	Rep: OFF		Rep: ON		Rep: OFF		Rep: ON					
	Sample rate (S/s)	Display record length (Word)	Sample rate (S/s)	Display record length (Word)	Sample rate (S/s)	Display record length (Word)	Sample rate (S/s)	Display record length (Word)	Sample rate (S/s)	Display record length (Word)	Sample rate (S/s)	Display record length (Word)
50 s	100	50 k	100	50 k	100	50 k	100	50 k	400 M	50 k	800 M	50 k
20 s	200	40 k	200	40 k	200	40 k	200	40 k	400 M	40 k	800 M	40 k
10 s	500	50 k	500	50 k	500	50 k	500	50 k	400 M	50 k	800 M	50 k
5 s	1 k	50 k	1 k	50 k	1 k	50 k	1 k	50 k	400 M	50 k	800 M	50 k
2 s	2 k	40 k	2 k	40 k	2 k	40 k	2 k	40 k	400 M	40 k	800 M	40 k
1 s	5 k	50 k	5 k	50 k	5 k	50 k	5 k	50 k	400 M	50 k	800 M	50 k
500 ms	10 k	50 k	10 k	50 k	10 k	50 k	10 k	50 k	400 M	50 k	800 M	50 k
200 ms	20 k	40 k	20 k	40 k	20 k	40 k	20 k	40 k	400 M	40 k	800 M	40 k
100 ms	50 k	50 k	50 k	50 k	50 k	50 k	50 k	50 k	400 M	50 k	800 M	50 k
50 ms	100 k	50 k	100 k	50 k	100 k	50 k	100 k	50 k	400 M	50 k	800 M	50 k
20 ms	200 k	40 k	200 k	40 k	200 k	40 k	200 k	40 k	400 M	40 k	800 M	40 k
10 ms	500 k	50 k	500 k	50 k	500 k	50 k	500 k	50 k	400 M	50 k	800 M	50 k
5 ms	1 M	50 k	1 M	50 k	1 M	50 k	1 M	50 k	400 M	50 k	800 M	50 k
2 ms	2 M	40 k	2 M	40 k	2 M	40 k	2 M	40 k	400 M	40 k	800 M	40 k
1 ms	5 M	50 k	5 M	50 k	5 M	50 k	5 M	50 k	400 M	50 k	800 M	50 k
500 μs	10 M	50 k	10 M	50 k	10 M	50 k	10 M	50 k	400 M	50 k	800 M	50 k
200 μs	20 M	40 k	20 M	40 k	20 M	40 k	20 M	40 k	400 M	40 k	800 M	40 k
100 μs	50 M	50 k	50 M	50 k	50 M	50 k	50 M	50 k	400 M	50 k	800 M	50 k
50 μs	100 M	50 k	100 M	50 k	100 M	50 k	100 M	50 k	400 M	50 k	800 M	50 k
20 μs	200 M	40 k	200 M	40 k	200 M	40 k	200 M	40 k	400 M	40 k	800 M	40 k
10 μs	500 M	50 k	500 M	50 k	500 M	50 k	500 M	50 k			1 G	50 k
5 μs	500 M	25 k	1 G	50 k	1 G	50 k	1 G	50 k	Set to normal mode even if envelope mode is specified.			
2 μs	500 M	10 k	2 G	40 k	1 G	20 k	2 G	40 k				
1 μs	500 M	5 k	5 G	50 k	1 G	10 k	5 G	50 k				
500 ns	500 M	2.5 k	10 G	50 k	1 G	5 k	10 G	50 k				
200 ns	500 M	1 k	20 G	40 k	1 G	2 k	20 G	40 k				
100 ns	500 M	500	50 G	50 k	1 G	1 k	50 G	50 k				
50 ns	500 M	250	100 G	50 k	1 G	500	100 G	50 k				
20 ns	500 M	100	100 G	20 k	1 G	200	100 G	20 k				
10 ns	100 G	10 k	100 G	10 k	100 G	10 k	100 G	10 k				
5 ns	100 G	5 k	100 G	5 k	100 G	5 k	100 G	5 k				
2 ns	100 G	2 k	100 G	2 k	100 G	2 k	100 G	2 k				
1 ns	100 G	1 k	100 G	1 k	100 G	1 k	100 G	1 k				

\* The values inside the thick frame are for repetitive sampling mode.

**Appendix 1 Relationship between the Time Axis Setting, Sample Rate and Record Length**

**Specified Record Length: 100 kW**

**Rep: Repetitive sampling mode**

Setting T/div	When set to a mode other than envelope mode								When set to envelope mode			
	When interleave mode is OFF				When interleave mode is ON				When interleave mode is OFF		When interleave mode is ON	
	Rep: OFF		Rep: ON		Rep: OFF		Rep: ON		Sample rate (S/s)	Display record length (Word)	Sample rate (S/s)	Display record length (Word)
	Sample rate (S/s)	Display record length (Word)	Sample rate (S/s)	Display record length (Word)	Sample rate (S/s)	Display record length (Word)	Sample rate (S/s)	Display record length (Word)	Sample rate (S/s)	Display record length (Word)	Sample rate (S/s)	Display record length (Word)
50 s	200	100 k	200	100 k	200	100 k	200	100 k	400 M	100 k	800 M	100 k
20 s	500	100 k	500	100 k	500	100 k	500	100 k	400 M	100 k	800 M	100 k
10 s	1 k	100 k	1 k	100 k	1 k	100 k	1 k	100 k	400 M	100 k	800 M	100 k
5 s	2 k	100 k	2 k	100 k	2 k	100 k	2 k	100 k	400 M	100 k	800 M	100 k
2 s	5 k	100 k	5 k	100 k	5 k	100 k	5 k	100 k	400 M	100 k	800 M	100 k
1 s	10 k	100 k	10 k	100 k	10 k	100 k	10 k	100 k	400 M	100 k	800 M	100 k
500 ms	20 k	100 k	20 k	100 k	20 k	100 k	20 k	100 k	400 M	100 k	800 M	100 k
200 ms	50 k	100 k	50 k	100 k	50 k	100 k	50 k	100 k	400 M	100 k	800 M	100 k
100 ms	100 k	100 k	100 k	100 k	100 k	100 k	100 k	100 k	400 M	100 k	800 M	100 k
50 ms	200 k	100 k	200 k	100 k	200 k	100 k	200 k	100 k	400 M	100 k	800 M	100 k
20 ms	500 k	100 k	500 k	100 k	500 k	100 k	500 k	100 k	400 M	100 k	800 M	100 k
10 ms	1 M	100 k	1 M	100 k	1 M	100 k	1 M	100 k	400 M	100 k	800 M	100 k
5 ms	2 M	100 k	2 M	100 k	2 M	100 k	2 M	100 k	400 M	100 k	800 M	100 k
2 ms	5 M	100 k	5 M	100 k	5 M	100 k	5 M	100 k	400 M	100 k	800 M	100 k
1 ms	10 M	100 k	10 M	100 k	10 M	100 k	10 M	100 k	400 M	100 k	800 M	100 k
500 μs	20 M	100 k	20 M	100 k	20 M	100 k	20 M	100 k	400 M	100 k	800 M	100 k
200 μs	50 M	100 k	50 M	100 k	50 M	100 k	50 M	100 k	400 M	100 k	800 M	100 k
100 μs	100 M	100 k	100 M	100 k	100 M	100 k	100 M	100 k	400 M	100 k	800 M	100 k
50 μs	200 M	100 k	200 M	100 k	200 M	100 k	200 M	100 k	400 M	100 k	800 M	100 k
20 μs	500 M	100 k	500 M	100 k	500 M	100 k	500 M	100 k	400 M	100 k	800 M	100 k
10 μs	500 M	100 k	1 G	100 k	1 G	100 k	1 G	100 k			1 G	100 k
5 μs	500 M	50 k	2 G	100 k	1 G	50 k	2 G	100 k	* Set to normal mode even if envelope mode is specified.			
2 μs	500 M	25 k	5 G	100 k	1 G	20 k	5 G	100 k				
1 μs	500 M	10 k	10 G	100 k	1 G	10 k	10 G	100 k				
500 ns	500 M	5 k	20 G	100 k	1 G	5 k	20 G	100 k				
200 ns	500 M	.52 k	50 G	100 k	1 G	2 k	50 G	100 k				
100 ns	500 M	1 k	100 G	100 k	1 G	1 k	100 G	100 k				
50 ns	500 M	500	100 G	50 k	1 G	500	100 G	50 k				
20 ns	500 M	250	100 G	20 k	1 G	200	100 G	20 k				
10 ns	100 G	100	100 G	10 k	100 G	10 k	100 G	10 k				
5 ns	100 G	5 k	100 G	5 k	100 G	5 k	100 G	5 k				
2 ns	100 G	2 k	100 G	2 k	100 G	2 k	100 G	2 k				
1 ns	100 G	1 k	100 G	1 k	100 G	1 k	100 G	1 k				

\* The values inside the thick frame are for repetitive sampling mode.

## Appendix 1 Relationship between the Time Axis Setting, Sample Rate and Record Length

Specified Record Length: 250 kW

Rep: Repetitive sampling mode

Setting  T/div	When set to a mode other than envelope mode								When set to envelope mode			
	When interleave mode is OFF				When interleave mode is ON				When interleave mode is OFF		When interleave mode is ON	
	Rep: OFF		Rep: ON		Rep: OFF		Rep: ON		Sample rate (S/s)	Display record length (Word)	Sample rate (S/s)	Display record length (Word)
	Sample rate (S/s)	Display record length (Word)	Sample rate (S/s)	Display record length (Word)	Sample rate (S/s)	Display record length (Word)	Sample rate (S/s)	Display record length (Word)	Sample rate (S/s)	Display record length (Word)	Sample rate (S/s)	Display record length (Word)
50 s	500	250 k	500	250 k	500	250 k	500	250 k	400 M	250 k	800 M	250 k
20 s	1 k	200 k	1 k	200 k	1 k	200 k	1k	200 k	400 M	200 k	800 M	200 k
10 s	2 k	200 k	2 k	200 k	2 k	200 k	2k	200 k	400 M	200 k	800 M	200 k
5 s	5 k	250 k	5 k	250 k	5 k	250 k	5k	250 k	400 M	250 k	800 M	250 k
2 s	10 k	200 k	10 k	200 k	10 k	200 k	10k	200 k	400 M	200 k	800 M	200 k
1 s	20 k	200 k	20 k	200 k	20 k	200 k	20k	200 k	400 M	200 k	800 M	200 k
500 ms	50 k	250 k	50 k	250 k	50 k	250 k	50k	250 k	400 M	250 k	800 M	250 k
200 ms	100 k	200 k	100 k	200 k	100 k	200 k	100k	200 k	400 M	200 k	800 M	200 k
100 ms	200 k	200 k	200 k	200 k	200 k	200 k	200k	200 k	400 M	200 k	800 M	200 k
50 ms	500 k	250 k	500 k	250 k	500 k	250 k	500k	250 k	400 M	250 k	800 M	250 k
20 ms	1 M	200 k	1 M	200 k	1 M	200 k	1M	200 k	400 M	200 k	800 M	200 k
10 ms	2 M	200 k	2 M	200 k	2 M	200 k	2M	200 k	400 M	200 k	800 M	200 k
5 ms	5 M	250 k	5 M	250 k	5 M	250 k	5M	250 k	400 M	250 k	800 M	250 k
2 ms	10 M	200 k	10 M	200 k	10 M	200 k	10M	200 k	400 M	200 k	800 M	200 k
1 ms	20 M	200 k	20 M	200 k	20 M	200 k	20M	200 k	400 M	200 k	800 M	200 k
500 μs	50 M	250 k	50 M	250 k	50 M	250 k	50M	250 k	400 M	250 k	800 M	250 k
200 μs	100 M	200 k	100 M	200 k	100 M	200 k	100M	200 k	400 M	200 k	800 M	200 k
100 μs	200 M	200 k	200 M	200 k	200 M	200 k	200M	200 k	400 M	200 k	800 M	200 k
50 μs	500 M	250 k	500 M	250 k	500 M	250 k	500M	250 k			1 G	250 k
20 μs	500 M	100 k	1 G	200 k	1 G	200 k	1G	200 k	<b>Set to normal mode even if envelope mode is specified.</b>			
10 μs	500 M	50 k	2 G	200 k	1 G	100 k	2G	200 k				
5 μs	500 M	25 k	5 G	250 k	1 G	50 k	5G	250 k				
2 μs	500 M	10 k	10 G	200 k	1 G	20 k	10G	200 k				
1 μs	500 M	5 k	20 G	200 k	1 G	10 k	20G	200 k				
500 ns	500 M	2.5 k	50 G	250 k	1 G	5 k	50G	250 k				
200 ns	500 M	1 k	100 G	200 k	1 G	2 k	100 G	200 k				
100 ns	500 M	500	100 G	100 k	1 G	1 k	100 G	100 k				
50 ns	500 M	250	100 G	50 k	1 G	500	100 G	50 k				
20 ns	500 M	100	100 G	20 k	1 G	200	100 G	20 k				
10 ns	100 G	10 k	100 G	10 k	100 G	10 k	100 G	10 k	*			
5 ns	100 G	5 k	100 G	5 k	100 G	5 k	100 G	5 k				
2 ns	100 G	2 k	100 G	2 k	100 G	2 k	100 G	2 k				
1 ns	100 G	1 k	100 G	1 k	100 G	1 k	100 G	1 k				

\* The values inside the thick frame are for repetitive sampling mode.

**Appendix 1 Relationship between the Time Axis Setting, Sample Rate and Record Length**

**Specified Record Length: 500 kW**

**Rep: Repetitive sampling mode**

Setting  T/div	When set to a mode other than envelope mode								When set to envelope mode			
	When interleave mode is OFF <sup>1</sup>				When interleave mode is ON				When interleave mode is OFF		When interleave mode is ON	
	Rep: OFF		Rep: ON		Rep: OFF		Rep: ON		Sample rate (S/s)	Display record length (Word)	Sample rate (S/s)	Display record length (Word)
	Sample rate (S/s)	Display record length (Word)	Sample rate (S/s)	Display record length (Word)	Sample rate (S/s)	Display record length (Word)	Sample rate (S/s)	Display record length (Word)	Sample rate (S/s)	Display record length (Word)	Sample rate (S/s)	Display record length (Word)
50 s	1 k	500 k	1 k	500 k	1 k	500 k	1 k	500 k	400 M	500 k	800 M	500 k
20 s	2 k	400 k	2 k	400 k	2 k	400 k	2 k	400 k	400 M	400 k	800 M	400 k
10 s	5 k	500 k	5 k	500 k	5 k	500 k	5 k	500 k	400 M	500 k	800 M	500 k
5 s	10 k	500 k	10 k	500 k	10 k	500 k	10 k	500 k	400 M	500 k	800 M	500 k
2 s	20 k	400 k	20 k	400 k	20 k	400 k	20 k	400 k	400 M	400 k	800 M	400 k
1 s	50 k	500 k	50 k	500 k	50 k	500 k	50 k	500 k	400 M	500 k	800 M	500 k
500 ms	100 k	500 k	100 k	500 k	100 k	500 k	100 k	500 k	400 M	500 k	800 M	500 k
200 ms	200 k	400 k	200 k	400 k	200 k	400 k	200 k	400 k	400 M	400 k	800 M	400 k
100 ms	500 k	500 k	500 k	500 k	500 k	500 k	500 k	500 k	400 M	500 k	800 M	500 k
50 ms	1 M	500 k	1 M	500 k	1 M	500 k	1 M	500 k	400 M	500 k	800 M	500 k
20 ms	2 M	400 k	2 M	400 k	2 M	400 k	2 M	400 k	400 M	400 k	800 M	400 k
10 ms	5 M	500 k	5 M	500 k	5 M	500 k	5 M	500 k	400 M	500 k	800 M	500 k
5 ms	10 M	500 k	10 M	500 k	10 M	500 k	10 M	500 k	400 M	500 k	800 M	500 k
2 ms	20 M	400 k	20 M	400 k	20 M	400 k	20 M	400 k	400 M	400 k	800 M	400 k
1 ms	50 M	500 k	50 M	500 k	50 M	500 k	50 M	500 k	400 M	500 k	800 M	500 k
500 μs	100 M	500 k	100 M	500 k	100 M	500 k	100 M	500 k	400 M	500 k	800 M	500 k
200 μs	200 M	400 k	200 M	400 k	200 M	400 k	200 M	400 k	400 M	400 k	800 M	400 k
100 μs	500 M	500 k	500 M	500 k	500 M	500 k	500 M	500 k			1 G	500 k
50 μs	500 M	500 k	1 G	500 k	1 G	500 k	1 G	500 k				
20 μs	500 M	250 k	2 G	400 k	1 G	200 k	2 G	400 k				
10 μs	500 M	100 k	5 G	500 k	1 G	100 k	5 G	500 k				
5 μs	500 M	50 k	10 G	500 k	1 G	50 k	10 G	500 k				
2 μs	500 M	25 k	20 G	400 k	1 G	20 k	20 G	400 k				
1 μs	500 M	10 k	50 G	500 k	1 G	10 k	50 G	500 k				
500 ns	500 M	5 k	100 G	500 k	1 G	5 k	100 G	500 k				
200 ns	500 M	2.5 k	100 G	200 k	1 G	2 k	100 G	200 k				
100 ns	500 M	1 k	100 G	100 k	1 G	1 k	100 G	100 k				
50 ns	500 M	500	100 G	50 k	1 G	500	100 G	50 k				
20 ns	500 M	250	100 G	20 k	1 G	200	100 G	20 k				
10 ns	100 G	100	100 G	10 k	100 G	10 k	100 G	10 k				
5 ns	100 G	5 k	100 G	5 k	100 G	5 k	100 G	5 k				
2 ns	100 G	2 k	100 G	2 k	100 G	2 k	100 G	2 k				
1 ns	100 G	1 k	100 G	1 k	100 G	1 k	100 G	1 k				

**Set to normal mode even if envelope mode is specified.**

<sup>2</sup>

1. Box averaging is not available on the DL1720E.
2. The values inside the thick frame are for repetitive sampling mode.

## Appendix 1 Relationship between the Time Axis Setting, Sample Rate and Record Length

Specified Record Length: 1 MW<sup>1</sup>

Rep: Repetitive sampling mode

Setting  T/div	When set to a mode other than envelope mode								When set to envelope mode				
	When interleave mode is OFF <sup>2</sup>				When interleave mode is ON <sup>3</sup>				When interleave mode is OFF		When interleave mode is ON		
	Rep: OFF		Rep: ON		Rep: OFF		Rep: ON		Sample rate (S/s)	Display record length (Word)	Sample rate (S/s)	Display record length (Word)	
	Sample rate (S/s)	Display record length (Word)	Sample rate (S/s)	Display record length (Word)	Sample rate (S/s)	Display record length (Word)	Sample rate (S/s)	Display record length (Word)	Sample rate (S/s)	Display record length (Word)	Sample rate (S/s)	Display record length (Word)	
Roll mode display	50 s	2 k	1 M	2 k	1 M	2 k	1 M	2 k	1 M	400 M	1 M	800 M	1 M
	20 s	5 k	1 M	5 k	1 M	5 k	1 M	5 k	1 M	400 M	1 M	800 M	1 M
	10 s	10 k	1 M	10 k	1 M	10 k	1 M	10 k	1 M	400 M	1 M	800 M	1 M
	5 s	20 k	1 M	20 k	1 M	20 k	1 M	20 k	1 M	400 M	1 M	800 M	1 M
	2 s	50 k	1 M	50 k	1 M	50 k	1 M	50 k	1 M	400 M	1 M	800 M	1 M
	1 s	100 k	1 M	100 k	1 M	100 k	1 M	100 k	1 M	400 M	1 M	800 M	1 M
	500 ms	200 k	1 M	200 k	1 M	200 k	1 M	200 k	1 M	400 M	1 M	800 M	1 M
	200 ms	500 k	1 M	500 k	1 M	500 k	1 M	500 k	1 M	400 M	1 M	800 M	1 M
	100 ms	1 M	1 M	1 M	1 M	1 M	1 M	1 M	1 M	400 M	1 M	800 M	1 M
	50 ms	2 M	1 M	2 M	1 M	2 M	1 M	2 M	1 M	400 M	1 M	800 M	1 M
	20 ms	5 M	1 M	5 M	1 M	5 M	1 M	5 M	1 M	400 M	1 M	800 M	1 M
	10 ms	10 M	1 M	10 M	1 M	10 M	1 M	10 M	1 M	400 M	1 M	800 M	1 M
	5 ms	20 M	1 M	20 M	1 M	20 M	1 M	20 M	1 M	400 M	1 M	800 M	1 M
	2 ms	50 M	1 M	50 M	1 M	50 M	1 M	50 M	1 M	400 M	1 M	800 M	1 M
	1 ms	100 M	1 M	100 M	1 M	100 M	1 M	100 M	1 M	400 M	1 M	800 M	1 M
	500 μs	200 M	1 M	200 M	1 M	200 M	1 M	200 M	1 M	400 M	1 M	800 M	1 M
	200 μs	500 M	1 M	500 M	1 M	500 M	1 M	500 M	1 M	400 M	1 M	800 M	1 M
	100 μs	500 M	500 k	1 G	1 M	1 G	1 M	1 G	1 M	<b>Set to normal mode even if envelope mode is specified.</b>			
	50 μs	500 M	250 k	2 G	1 M	1 G	500 k	2 G	1 M				
	20 μs	500 M	100 k	5 G	1 M	1 G	200 k	5 G	1 M				
	10 μs	500 M	50 k	10 G	1 M	1 G	100 k	10 G	1 M				
	5 μs	500 M	25 k	20 G	1 M	1 G	50 k	20 G	1 M				
	2 μs	500 M	10 k	50 G	1 M	1 G	20 k	50 G	1 M				
	1 μs	500 M	5 k	100 G	1 M	1 G	10 k	100 G	1 M				
	500 ns	500 M	2.5 k	100 G	500 k	1 G	5 k	100 G	500 k				
	200 ns	500 M	1 k	100 G	200 k	1 G	2 k	100 G	200 k				
	100 ns	500 M	500	100 G	100 k	1 G	1 k	100 G	100 k				
	50 ns	500 M	250	100 G	50 k	1 G	500	100 G	50 k				
	20 ns	500 M	100	100 G	20 k	1 G	200	100 G	20 k				
	10 ns	100 G	10 k	100 G	10 k	100 G	10 k	100 G	10 k				
	5 ns	100 G	5 k	100 G	5 k	100 G	5 k	100 G	5 k				
	2 ns	100 G	2 k	100 G	2 k	100 G	2 k	100 G	2 k				
1 ns	100 G	1 k	100 G	1 k	100 G	1 k	100 G	1 k					

1. This record length cannot be specified on the DL1720E when interleave mode is OFF.
2. Box averaging is not available on the DL1740E.
3. Box averaging is not available on the DL1720E.
4. The values inside the thick frame are for repetitive sampling mode.



**Appendix 1 Relationship between the Time Axis Setting, Sample Rate and Record Length**

**Specified Record Length: 2 MW<sup>1</sup>**

**Rep: Repetitive sampling mode**

Setting  T/div	When set to a mode other than envelope mode								When set to envelope mode			
	When interleave mode is OFF				When interleave mode is ON <sup>3</sup>				When interleave mode is OFF		When interleave mode is ON	
	Rep: OFF		Rep: ON		Rep: OFF		Rep: ON		Sample rate (S/s)	Display record length (Word)	Sample rate (S/s)	Display record length (Word)
	Sample rate (S/s)	Display record length (Word)	Sample rate (S/s)	Display record length (Word)	Sample rate (S/s)	Display record length (Word)	Sample rate (S/s)	Display record length (Word)				
50 s	5 k	2.5 M <sup>2</sup>	5 k	2.5 M <sup>2</sup>	5 k	2.5 M <sup>2</sup>	5 k	2.5 M <sup>2</sup>	400 M	2.5 M <sup>2</sup>	800 M	2.5 M <sup>2</sup>
20 s	10 k	2 M	10 k	2 M	10 k	2 M	10 k	2 M	400 M	2 M	800 M	2 M
10 s	20 k	2 M	20 k	2 M	20 k	2 M	20 k	2 M	400 M	2 M	800 M	2 M
5 s	50 k	2.5 M <sup>2</sup>	50 k	2.5 M <sup>2</sup>	50 k	2.5 M <sup>2</sup>	50 k	2.5 M <sup>2</sup>	400 M	2.5 M <sup>2</sup>	800 M	2.5 M <sup>2</sup>
2 s	100 k	2 M	100 k	2 M	100 k	2 M	100 k	2 M	400 M	2 M	800 M	2 M
1 s	200 k	2 M	200 k	2 M	200 k	2 M	200 k	2 M	400 M	2 M	800 M	2 M
500 ms	500 k	2.5 M <sup>2</sup>	500 k	2.5 M <sup>2</sup>	500 k	2.5 M <sup>2</sup>	500 k	2.5 M <sup>2</sup>	400 M	2.5 M <sup>2</sup>	800 M	2.5 M <sup>2</sup>
200 ms	1 M	2 M	1 M	2 M	1 M	2 M	1 M	2 M	400 M	2 M	800 M	2 M
100 ms	2 M	2 M	2 M	2 M	2 M	2 M	2 M	2 M	400 M	2 M	800 M	2 M
50 ms	5 M	2.5 M <sup>2</sup>	5 M	2.5 M <sup>2</sup>	5 M	2.5 M <sup>2</sup>	5 M	2.5 M <sup>2</sup>	400 M	2.5 M <sup>2</sup>	800 M	2.5 M <sup>2</sup>
20 ms	10 M	2 M	10 M	2 M	10 M	2 M	10 M	2 M	400 M	2 M	800 M	2 M
10 ms	20 M	2 M	20 M	2 M	20 M	2 M	20 M	2 M	400 M	2 M	800 M	2 M
5 ms	50 M	2.5 M <sup>2</sup>	50 M	2.5 M <sup>2</sup>	50 M	2.5 M <sup>2</sup>	50 M	2.5 M <sup>2</sup>	400 M	2.5 M <sup>2</sup>	800 M	2.5 M <sup>2</sup>
2 ms	100 M	2 M	100 M	2 M	100 M	2 M	100 M	2 M	400 M	2 M	800 M	2 M
1 ms	200 M	2 M	200 M	2 M	200 M	2 M	200 M	2 M	400 M	2 M	800 M	2 M
500 μs	500 M	2.5 M <sup>2</sup>	500 M	2.5 M <sup>2</sup>	500 M	2.5 M <sup>2</sup>	500 M	2.5 M <sup>2</sup>	<b>Set to normal mode even if envelope mode is specified.</b>		1 G	2.5 M <sup>2</sup>
200 μs	500 M	1 M	1 G	2 M	1 G	2 M	1 G	2 M				
100 μs	500 M	500 k	2 G	2 M	1 G	1 M	2 G	2 M				
50 μs	500 M	250 k	5 G	2.5 M <sup>2</sup>	1 G	500 k	5 G	2.5 M <sup>2</sup>				
20 μs	500 M	100 k	10 G	2 M	1 G	200 k	10 G	2 M				
10 μs	500 M	50 k	20 G	2 M	1 G	100 k	20 G	2 M				
5 μs	500 M	25 k	50 G	2.5 M <sup>2</sup>	1 G	50 k	50 G	2.5 M <sup>2</sup>				
2 μs	500 M	10 k	100 G	2 M	1 G	20 k	100 G	2 M				
1 μs	500 M	5 k	100 G	1 M	1 G	10 k	100 G	1 M				
500 ns	500 M	2.5 k	100 G	500 k	1 G	5 k	100 G	500 k				
200 ns	500 M	1 k	100 G	200 k	1 G	2 k	100 G	200 k				
100 ns	500 M	500	100 G	100 k	1 G	1 k	100 G	100 k				
50 ns	500 M	250	100 G	50 k	1 G	500	100 G	50 k				
20 ns	500 M	100	100 G	20 k	1 G	200	100 G	20 k				
10 ns	100 G	10 k	100 G	10 k	100 G	10 k	100 G	10 k				
5 ns	100 G	5 k	100 G	5 k	100 G	5 k	100 G	5 k				
2 ns	100 G	2 k	100 G	2 k	100 G	2 k	100 G	2 k				
1 ns	100 G	1 k	100 G	1 k	100 G	1 k	100 G	1 k				

1. This record length cannot be specified on the DL1720E.  
Also, this record length cannot be specified on the DL1740E when interleave mode is OFF.
2. Since the number of data points acquired is 2 MW, only eight divisions of the waveform is displayed along the time axis.  
In addition, the trigger position in this case is set by taking eight divisions as 100%.
3. Box averaging is not available on the DL1740E.
4. The values inside the thick frame are for repetitive sampling mode.

## Appendix 1 Relationship between the Time Axis Setting, Sample Rate and Record Length

Specified Record Length: 4 MW<sup>1</sup>

Rep: Repetitive sampling mode

Setting  T/div	When set to a mode other than envelope mode								When set to envelope mode				
	When interleave mode is OFF <sup>3</sup>				When interleave mode is ON				When interleave mode is OFF		When interleave mode is ON		
	Rep: OFF		Rep: ON		Rep: OFF		Rep: ON		Sample rate (S/s)	Display record length (Word)	Sample rate (S/s)	Display record length (Word)	
	Sample rate (S/s)	Display record length (Word)	Sample rate (S/s)	Display record length (Word)	Sample rate (S/s)	Display record length (Word)	Sample rate (S/s)	Display record length (Word)	Sample rate (S/s)	Display record length (Word)	Sample rate (S/s)	Display record length (Word)	
Roll mode display	50 s	10 k	5 M <sup>2</sup>	10 k	5 M <sup>2</sup>	10 k	5 M <sup>2</sup>	10 k	5 M <sup>2</sup>	400 M	5 M <sup>2</sup>	800 M	5 M <sup>2</sup>
	20 s	20 k	4 M	20 k	4 M	20 k	4 M	20 k	4 M	400 M	4 M	800 M	4 M
	10 s	50 k	5 M <sup>2</sup>	50 k	5 M <sup>2</sup>	50 k	5 M <sup>2</sup>	50 k	5 M <sup>2</sup>	400 M	5 M <sup>2</sup>	800 M	5 M <sup>2</sup>
	5 s	100 k	5 M <sup>2</sup>	100 k	5 M <sup>2</sup>	100 k	5 M <sup>2</sup>	100 k	5 M <sup>2</sup>	400 M	5 M <sup>2</sup>	800 M	5 M <sup>2</sup>
	2 s	200 k	4 M	200 k	4 M	200 k	4 M	200 k	4 M	400 M	4 M	800 M	4 M
	1 s	500 k	5 M <sup>2</sup>	500 k	5 M <sup>2</sup>	500 k	5 M <sup>2</sup>	500 k	5 M <sup>2</sup>	400 M	5 M <sup>2</sup>	800 M	5 M <sup>2</sup>
	500 ms	1 M	5 M <sup>2</sup>	1 M	5 M <sup>2</sup>	1 M	5 M <sup>2</sup>	1 M	5 M <sup>2</sup>	400 M	5 M <sup>2</sup>	800 M	5 M <sup>2</sup>
	200 ms	2 M	4 M	2 M	4 M	2 M	4 M	2 M	4 M	400 M	4 M	800 M	4 M
	100 ms	5 M	5 M <sup>2</sup>	5 M	5 M <sup>2</sup>	5 M	5 M <sup>2</sup>	5 M	5 M <sup>2</sup>	400 M	5 M <sup>2</sup>	800 M	5 M <sup>2</sup>
	50 ms	10 M	5 M <sup>2</sup>	10 M	5 M <sup>2</sup>	10 M	5 M <sup>2</sup>	10 M	5 M <sup>2</sup>	400 M	5 M <sup>2</sup>	800 M	5 M <sup>2</sup>
	20 ms	20 M	4 M	20 M	4 M	20 M	4 M	20 M	4 M	400 M	4 M	800 M	4 M
	10 ms	50 M	5 M <sup>2</sup>	50 M	5 M <sup>2</sup>	50 M	5 M <sup>2</sup>	50 M	5 M <sup>2</sup>	400 M	5 M <sup>2</sup>	800 M	5 M <sup>2</sup>
	5 ms	100 M	5 M <sup>2</sup>	100 M	5 M <sup>2</sup>	100 M	5 M <sup>2</sup>	100 M	5 M <sup>2</sup>	400 M	5 M <sup>2</sup>	800 M	5 M <sup>2</sup>
	2 ms	200 M	4 M	200 M	4 M	200 M	4 M	200 M	4 M	400 M	4 M	800 M	4 M
	1 ms	500 M	5 M <sup>2</sup>	500 M	5 M <sup>2</sup>	500 M	5 M <sup>2</sup>	500 M	5 M <sup>2</sup>	400 M	5 M <sup>2</sup>	800 M	5 M <sup>2</sup>
	500 μs	500 M	2.5 M	1 G	5 M <sup>2</sup>	1 G	5 M <sup>2</sup>	1 G	5 M <sup>2</sup>	Set to normal mode even if envelope mode is specified.			
	200 μs	500 M	1 M	2 G	4 M	1 G	2 M	2 G	4 M				
	100 μs	500 M	500 k	5 G	5 M <sup>2</sup>	1 G	1 M	5 G	5 M <sup>2</sup>				
	50 μs	500 M	250 k	10 G	5 M <sup>2</sup>	1 G	500 k	10 G	5 M <sup>2</sup>				
	20 μs	500 M	100 k	20 G	4 M	1 G	200 k	20 G	4 M				
	10 μs	500 M	50 k	50 G	5 M <sup>2</sup>	1 G	100 k	50 G	5 M <sup>2</sup>				
	5 μs	500 M	25 k	100 G	5 M <sup>2</sup>	1 G	50 k	100 G	5 M <sup>2</sup>				
	2 μs	500 M	10 k	100 G	2 M	1 G	20 k	100 G	2 M				
	1 μs	500 M	5 k	100 G	1 M	1 G	10 k	100 G	1 M				
	500 ns	500 M	2.5 k	100 G	500 k	1 G	5 k	100 G	500 k				
	200 ns	500 M	1 k	100 G	200 k	1 G	2 k	100 G	200 k				
	100 ns	500 M	500	100 G	100 k	1 G	1 k	100 G	100 k				
	50 ns	500 M	250	100 G	50 k	1 G	500	100 G	50 k				
	20 ns	500 M	100	100 G	20 k	1 G	200	100 G	20 k				
	10 ns	100 G	10 k	100 G	10 k	100 G	10 k	100 G	10 k				
5 ns	100 G	5 k	100 G	5 k	100 G	5 k	100 G	5 k					
2 ns	100 G	2 k	100 G	2 k	100 G	2 k	100 G	2 k					
1 ns	100 G	1 k	100 G	1 k	100 G	1 k	100 G	1 k					

1. This record length cannot be specified on the DL1720E or DL1740E.
2. Since the number of data points acquired is 4 MW, only eight divisions of the waveform is displayed along the time axis.  
In addition, the trigger position in this case is set by taking eight divisions as 100%.
3. Box average, averaging (simple average), and computation cannot be performed.
4. The values inside the thick frame are for repetitive sampling mode.

**Appendix 1 Relationship between the Time Axis Setting, Sample Rate and Record Length**

**Specified Record Length: 8 MW<sup>1</sup>**

**Rep: Repetitive sampling mode**

Setting T/div	When set to a mode other than envelope mode								When set to envelope mode			
	When interleave mode is OFF				When interleave mode is ON <sup>3</sup>				When interleave mode is OFF		When interleave mode is ON	
	Rep: OFF		Rep: ON		Rep: OFF		Rep: ON		Sample rate (S/s)	Display record length (Word)	Sample rate (S/s)	Display record length (Word)
	Sample rate (S/s)	Display record length (Word)	Sample rate (S/s)	Display record length (Word)	Sample rate (S/s)	Display record length (Word)	Sample rate (S/s)	Display record length (Word)				
50 s	This record length cannot be used when interleave mode is OFF.				20 k	10 M <sup>2</sup>	20 k	10 M <sup>2</sup>	This record length cannot be used when interleave mode is OFF.		800 M	10 M <sup>2</sup>
20 s					50 k	10 M <sup>2</sup>	50 k	10 M <sup>2</sup>			800 M	10 M <sup>2</sup>
10 s					100 k	10 M <sup>2</sup>	100 k	10 M <sup>2</sup>			800 M	10 M <sup>2</sup>
5 s					200 k	10 M <sup>2</sup>	200 k	10 M <sup>2</sup>			800 M	10 M <sup>2</sup>
2 s					500 k	10 M <sup>2</sup>	500 k	10 M <sup>2</sup>			800 M	10 M <sup>2</sup>
1 s					1 M	10 M <sup>2</sup>	1 M	10 M <sup>2</sup>			800 M	10 M <sup>2</sup>
500 ms					2 M	10 M <sup>2</sup>	2 M	10 M <sup>2</sup>			800 M	10 M <sup>2</sup>
200 ms					5 M	10 M <sup>2</sup>	5 M	10 M <sup>2</sup>			800 M	10 M <sup>2</sup>
100 ms					10 M	10 M <sup>2</sup>	10 M	10 M <sup>2</sup>			800 M	10 M <sup>2</sup>
50 ms					20 M	10 M <sup>2</sup>	20 M	10 M <sup>2</sup>			800 M	10 M <sup>2</sup>
20 ms					50 M	10 M <sup>2</sup>	50 M	10 M <sup>2</sup>			800 M	10 M <sup>2</sup>
10 ms					100 M	10 M <sup>2</sup>	100 M	10 M <sup>2</sup>			800 M	10 M <sup>2</sup>
5 ms					200 M	10 M <sup>2</sup>	200 M	10 M <sup>2</sup>			800 M	10 M <sup>2</sup>
2 ms					500 M	10 M <sup>2</sup>	500 M	10 M <sup>2</sup>			1 G	10 M <sup>2</sup>
1 ms					1 G	10 M <sup>2</sup>	1 G	10 M <sup>2</sup>			Set to normal mode even if envelope mode is specified.	
500 μs					1 G	5 M	2 G	10 M <sup>2</sup>				
200 μs					1 G	2 M	5 G	10 M <sup>2</sup>				
100 μs					1 G	1 M	10 G	10 M <sup>2</sup>				
50 μs					1 G	500 k	20 G	10 M <sup>2</sup>				
20 μs					1 G	200 k	50 G	10 M <sup>2</sup>				
10 μs	1 G	100 k	100 G	10 M <sup>2</sup>								
5 μs	1 G	50 k	100 G	5 M								
2 μs	1 G	20 k	100 G	2 M								
1 μs	1 G	10 k	100 G	1 M								
500 ns	1 G	5 k	100 G	500 k								
200 ns	1 G	2 k	100 G	200 k								
100 ns	1 G	1 k	100 G	100 k								
50 ns	1 G	500	100 G	50 k								
20 ns	1 G	200	100 G	20 k								
10 ns	100 G	10 k	100 G	10 k								
5 ns	100 G	5 k	100 G	5 k								
2 ns	100 G	2 k	100 G	2 k								
1 ns	100G	1 k	100 G	1 k								

1. This record length cannot be specified on the DL1720E or DL1740E.
2. Since the number of data points acquired is 8 MW, only eight divisions of the waveform is displayed along the time axis. In addition, the trigger position in this case is set by taking eight divisions as 100%.
3. Box average, averaging (simple average), and computation cannot be performed.
4. The values inside the thick frame are for repetitive sampling mode.

# Appendix 2 How to Calculate the Area of a Waveform

## Integ1TY

Total Area for Positive Side Only:  $S_1+S_2$

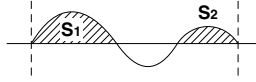

## Integ2TY

Total Area for both Positive and Negative Sides:  $S_1+S_3-S_2$

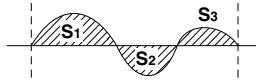

## Integ1XY

(1) Multiple Loops

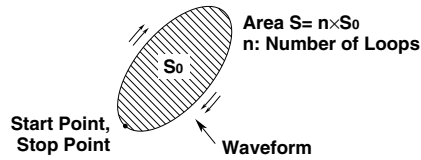

(2) Non-Closed Curve

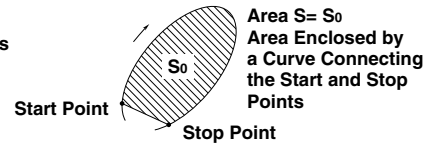

(3) Loop Tracing a Figure-Eight

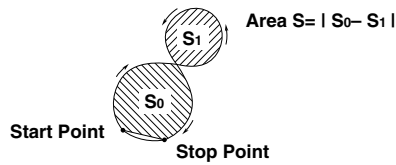

(4) Spiral Loop

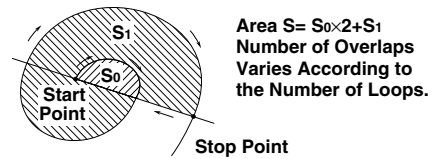

**Appendix 2 How to Calculate the Area of a Waveform**

**Integ2XY**

(1) When Only One Y Data Corresponds to X Data

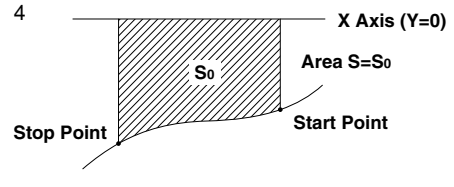
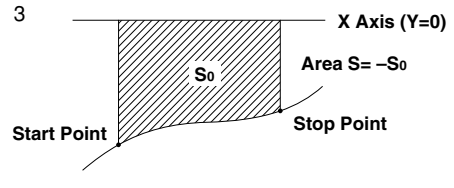
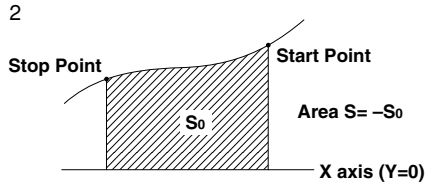
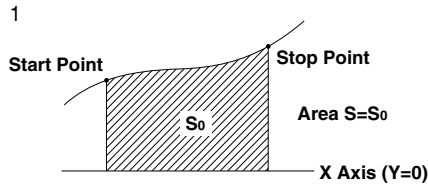

(2) When the Waveform Extends into the Negative Side

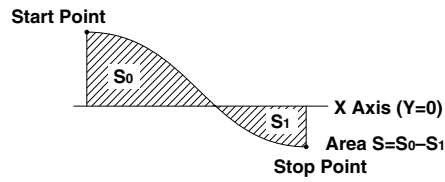

(3) When Two or more Y Data Correspond to X Data

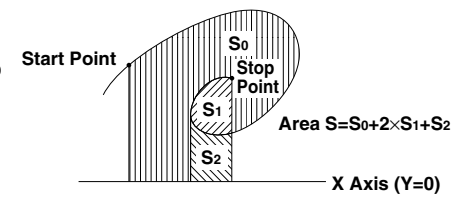
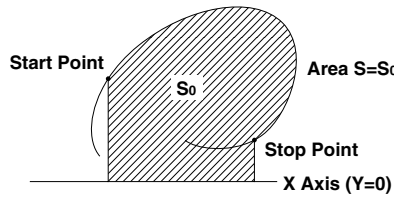

## Appendix 3 ASCII Header File Format

//YOKOGAWA ASCII FILE FORMAT

\$PublicInfo

FormatVersion 1.11  
Model DL1700E  
Endian Big  
DataFormat Trace  
GroupNumber 2  
TraceTotalNumber 6  
DataOffset 0

\$Group1

TraceNumber	4			
BlockNumber	1			
TraceName	CH1	CH2	CH3	CH4
BlockSize	1002	1002	1002	1002
VResolution	1.5625000E+00	1.5625000E+00	1.5625000E+00	1.5625000E+00
VOffset	0.0000000E+00	0.0000000E+00	0.0000000E+00	0.0000000E+00
VDataType	IS2	IS2	IS2	IS2
VUnit	V	V	A	V
VPlusOverData	32768	32768	32768	32768
VMinusOverData	-32769	-32769	-32769	-32769
VIllegalData	-32769	-32769	-32769	-32769
VMaxData	32767	32767	32767	32767
VMinData	-32768	-32768	-32768	-32768
HResolution	5.0000000E-09	5.0000000E-09	5.0000000E-09	5.0000000E-09
HOffset	-2.5000000E-06	-2.5000000E-06	-2.5000000E-06	-2.5000000E-06
HUnit	s	s	s	s
Date	2004/06/25	2004/06/25	2004/06/25	2004/06/25
Time	01:45:00	01:45:00	01:45:00	01:45:00

### Appendix 3 ASCII Header File Format

---

\$Group2						
TraceNumber	2					
BlockNumber	1					
TraceName	MATH1		MATH2			
BlockSize	1002		1002			
VResolution	6.1035156E-03		1.2207031E+00			
VOffset	-7.7000000E+01		2.0000000E+04			
VDataType	IS2		IS2			
VUnit	DB		V			
VPlusOverData	32768		32768			
VMinusOverData	-32769		-32769			
VIllegalData	-32769		-32769			
VMaxData	32767		32767			
VMinData	-32768		-32768			
HResolution	2.0000000E-01		5.0000000E-09			
HOffset	0.0000000E+00		-2.5000000E-06			
HUnit	Hz		s			
Date	2004/06/25		2004/06/25			
Time	01:45:00		01:45:00			
\$PrivateInfo						
DisplayBlockSize	1002	1002	1002	1002	1002	1002
DisplayPointNo.	1	1	1	1	1	1
ModelVersion	1.00					
PhaseShift	0.000000	0.000000	0.000000	0.000000	0.000000	0.000000
PTraceName	CH1	CH2	CH3	CH4	Math1	Math2

---

**Note**

- The header file is common to many of YOKOGAWA's measuring instruments. Therefore, data that is not required by this instrument (0s) is also included.
  - CH3, CH4, and Math2 are not available on the DL1720E.
-

**\$PublicInfo (Common Information)**

FormatVersion:	Header file version number (common to YOKOGAWA's header files)
Model:	Model name
Endian:	Endian mode when saving data (Big/Ltl) <sup>1</sup>
DataFormat:	Storage format of the binary waveform data (Trace/Block) <sup>2</sup>
GroupNumber:	The number of "\$Group"s indicated below
TraceTotalNumber:	Total number of selected waveforms
DataOffset:	Start position of the binary waveform data <sup>3</sup>

**\$Group1 (Group Information)**

TraceNumber:	Number of waveforms in this group
BlockNumber:	Number of blocks in this group <sup>4</sup>
TraceName:	Name of each waveform
BlockSize:	Number of data points in a single block of each waveform
Vresolution:	Value of coefficient VResolution of the Y-axis conversion equation of each waveform <sup>5</sup>
Voffset:	Value of coefficient VOffset of the Y-axis conversion equation of each waveform <sup>5</sup>
VdataType:	Type of binary file waveform data for each waveform <sup>6</sup>
Vunit:	Unit used on the Y-axis of each waveform (no effect on the data)
VplusOverData:	Error data when the binary data of each waveform is greater than or equal to this value
VminusOverData:	Error data when the binary data of each waveform is less than or equal to this value
VmaxData:	Maximum value of binary data for each waveform
VminData:	Minimum value of binary data for each waveform
Hresolution:	Value of coefficient HResolution of the X-axis conversion equation of each waveform <sup>7</sup>
Hoffset:	Value of coefficient HOffset of the X-axis conversion equation of each waveform <sup>7</sup>
Hunit:	Unit used on the X-axis of each waveform (no effect on the data)
Date:	Date when waveform acquisition was completed
Time:	Time when waveform acquisition was completed

For details on 1 to 7, see the next page.

**\$PrivateInfo (Model-Specific Information)**

MathBlockNo.:	Block number of the item to be computed
DisplayBlockSize:	Length of the data displayed on the screen (display record length)
DisplayPointNo.:	Value indicating the memory position (nth point in the memory) corresponding the left end of the display record length (display offset, 1 when the specified record length = display record length).
ModelVersion:	Version number of the instrument
PhaseShift:	Phase information (lead: -, lag: +)
PTraceName:	Name of each waveform

\* Actual display offset of the phase-shifted waveform = DisplayPointNo.-PhaseShift



### Creation of ASCII Header Files

When waveform data (Waveform) is stored to a floppy disk or PC card, the following two files will be created automatically in the DL\_WAVE directory.

- Waveform display data file (\*.wvf)
- ASCII header file (\*.hdr)

The waveform data file can be recalled to the instrument using the FILE menu. The ASCII header files explained here cannot be viewed on the instrument. Use the data such as when analyzing the waveforms on your PC.

**1. Endian mode when saving data**

Big: Motorola 68000-family data  
Ltl: Intel 86 family data

**2. Storage format of the binary waveform data**

Trace: Groups into blocks, each block for a single waveform.  
Block: Groups into blocks, each block for a given time interval.

**3. Start point of the binary waveform data**

Offset from the beginning of the file

**4. Maximum number of blocks in the group**

Maximum number of blocks applies if the number of blocks varies between waveforms.

**5. Y axis conversion equation for each waveform**

$Y\text{-axis value} = V\text{Resolution} \times \text{raw data} + V\text{Offset}$

**6. Data Type**

ISn: n-byte signed integer  
IUn: n-byte unsigned integer  
FSn: n-byte signed real number  
FUn: n-byte unsigned real number  
Bm: m-bit data

**7. X axis conversion equation for each waveform**

$X\text{ axis value} = H\text{Resolution} \times (\text{Data No.} - 1) + H\text{Offset}$

## Appendix 4 List of Default Values

Key	Soft Key	Default Setting
<b>CH1 thru 4 (or CH1 thru 2 on the DL1720E)</b>		
	Display	ON
	Position	0div
	Coupling	DC1 MΩ
	Probe	10:1
	Offset	0.00 V
	Bandwidth	Full
	Variable	50 V
	Linear Scl	OFF
	Label	Channel name
<b>V/div</b>		
		50V/div
<b>T/div</b>		
		1ms/div
<b>PRESET</b>		
	Select	All
	Type	CMOS (5 V)
	Probe	10:1
<b>MODE</b>		
	Mode	Auto
<b>SIMPLE</b>		
	Source	CH1
	Level	0 V
	Slope	Rising
	Coupling	DC
	HF Reject	OFF
	Hysteresis	Small
	Hold Off	0.08 μs
<b>POSITON</b>		
	Position	50%
<b>DELAY</b>		
	Delay	0S
<b>ACTION</b>		
	Buzzer	OFF
	Save to File	OFF
	Hard Copy	OFF
	Image Save	OFF
	ACQ Count	Infinite
	Send Mail	OFF
	Mail Count	100
<b>ACQ</b>		
	Record Length	10k
	Mode	Normal
	Count	Infinite
	Interleave	OFF
	Repetitive	OFF
	Time Base	Int
<b>HISTORY</b>		
	Select Record	0
	Display Mode	One
	Start Rec	0
	End Rec	Oldest number
	Show Map No.	1
	Search Mode	OFF
<b>ZOOM</b>		
	Mode	Main

Key	Soft Key	Default Setting
<b>SEARCH</b>		
	Type	Edge
	Z1 Mag	× 2
	Z1 Pos	0 div
<b>DISPLAY</b>		
	Format	Quad (DL1720E, Dual)
	Interpolation	Sine
	Graticule	Grid
	Scale Value	OFF
	Trace Label	OFF
	Accumul: e	OFF
	Translucent	OFF
	Mapping	Auto
<b>X-Y</b>		
	Mode	T-Y
<b>FILE</b>		
	File Item	Setup
<b>MEASURE</b>		
	Mode	OFF
	Item Setup	
	Source	CH1
	Item	OFF
	Delay Setup	
	Source	CH1
	Mode	OFF
	1Cycle Mode	OFF
	T-Range1	-5.000 div
	T-Range2	5.000 div
	Trace	CH1
	Distal	90%
	Mesial	50%
	Proximal	10%
	High/Low	Auto
<b>CURSOR</b>		
	Type	OFF
<b>GO/NO-GO</b>		
	Mode	OFF
<b>MATH (M2(Math2) not available on the DL1720E)</b>		
	M1 Display	OFF
	M1 Setup	C1+C2
	M1 Label	Math1
	M2 Display	OFF
	M2 Setup	C3+C4
	M2 Label	Math2
<b>PHASE</b>		
	Mode	OFF
<b>COPY(MENU)</b>		
	Copy to	Built-in
	Format	Normal
	Information	OFF
<b>IMAGE SAVE(MENU)</b>		
	Format	TIFF
	Color	OFF
	File Name	0000

# Appendix 5 Key Assignments of the USB Keyboard

## 104 Keyboard (US)/89 Keyboard (US)

Key	When Pressed with the Control Key		When the Soft Keyboard Is Displayed		Other	
		+Shift*		+Shift*		+Shift*
a	ACQ menu	Same as left	a	A		
b	MATH menu	Same as left	b	B		
c	Execute COPY	Same as left	c	C		
d	DISPLAY menu	Same as left	d	D		
e	ENHANCED menu	Same as left	e	E		
f	FILE menu	Same as left	f	F		
g	GO/NOGO menu	Same as left	g	G		
h	HISTORY menu	Same as left	h	H		
i	Execute IMAGE SAVE	Same as left	i	I		
j	PRESET menu	Same as left	j	J		
k			k	K		
l			l	L		
m	MEASURE menu	Same as left	m	M		
n			n	N		
o			o	O		
p	POSITION menu	Same as left	p	P		
q	Execute CLEAR TRACE	Same as left	q	Q		
r	Execute RESET	Same as left	r	R		
s	SHIFT condition	Same as left	s	S		
t	TRIGMODE menu	Same as left	t	T		
u	CURSOR menu	Same as left	u	U		
v			v	V		
w	SIMPLE menu	Same as left	w	W		
x			x	X		
y			y	Y		
z	ZOOM menu	Same as left	z	Z		
1	CH1 menu		1	!		
2	CH2 menu		2	@		
3	CH3 menu		3	#		
4	CH4 menu		4	\$		
5			5	%		
6			6	^		
7			7	&		
8			8	*		
9			9	(		
0			0	)		
Enter	Return(Enter),Select	Same as left	Return(Enter)	Same as left	Return(Enter)	Same as left
Esc	Escape	Same as left	Escape	Same as left	Escape	Same as left
Back Space			Back Space	Same as left		
Tab						
Space Bar			Space Bar	Same as left		
-			-	_		
=			=	+		
[			[	{		
]			]	}		
\	SETUP	Same as left	\			
;			;	:		
'			'	"		
,			,	<		
.			.	>		
/	MISC menu	Execute HELP	/	?		
Caps Lock			Caps Lock	Same as left		

## Appendix 5 Key Assignments of the USB Keyboard

F1	Select soft key1	Same as left	Select soft key1	Same as left	Select soft key1	Same as left
F2	Select soft key2	Same as left	Select soft key2	Same as left	Select soft key2	Same as left
F3	Select soft key3	Same as left	Select soft key3	Same as left	Select soft key3	Same as left
F4	Select soft key4	Same as left	Select soft key4	Same as left	Select soft key4	Same as left
F5	Select soft key5	Same as left	Select soft key5	Same as left	Select soft key5	Same as left
F6	Select soft key6	Same as left	Select soft key6	Same as left	Select soft key6	Same as left
F7	Select soft key7	Same as left	Select soft key7	Same as left	Select soft key7	Same as left
F8	Escape	Same as left	Escape	Same as left	Escape	Same as left
F9						
F10						
F11			μ	Same as left		
F12	START/STOP	Same as left	Ω	Same as left	START/STOP	Same as left
Print Screen	Execute COPY	Same as left				
Scroll Lock	Execute IMAGE SAVE	Same as left				
Pause	Execute SNAPSHOT	Same as left				
Insert			Insert condition	Same as left		
Home	Decrement V/Div	Same as left			Decrement V/Div	Same as left
Page Up	Decrement T/Div	Same as left			Decrement T/Div	Same as left
Delete			Delete	Same as left		
End	Increment V/Div	Same as left			Increment V/Div	Same as left
Page Down	Increment T/Div	Same as left			Increment T/Div	Same as left
→	Cursor to the right	Same as left	Cursor to the right	Same as left	Cursor to the right	Same as left
←	Cursor to the left	Same as left	Cursor to the left	Same as left	Cursor to the left	Same as left
↓	Jog shuttle down	Same as left	Select soft key6	Same as left	Jog shuttle down	Same as left
↑	Jog shuttle up	Same as left	Select soft key6	Same as left	Jog shuttle up	Same as left
(Numeric)						
Num Lock						
/			/	Same as left		
*	START/STOP	Same as left	*	Same as left	START/STOP	Same as left
-			-	Same as left		
+			+	Same as left		
Enter			Return(Enter)	Same as left	Return(Enter),Select	Same as left
1	CH1 menu	Increment V/Div	1			Increment V/Div
2	CH2 menu	Jog shuttle down	2			Jog shuttle down
3	CH3 menu	Increment T/Div	3			Increment T/Div
4	CH4 menu	Cursor to the left	4			Cursor to the left
5			5			
6		Cursor to the right	6			Cursor to the right
7		Decrement V/Div	7			Decrement V/Div
8		Jog shuttle up	8			Jog shuttle up
9		Decrement T/Div	9			Decrement T/Div
0			0	Insert condition		
.			.	DELETE		

\* The operation of the key when holding down the Shift key on the USB keyboard.

Appendix 5 Key Assignments of the USB Keyboard

109 Keyboard (Japanese)/89 Keyboard (Japanese)

Key	When Pressed with the Control Key		When the Soft Keyboard Is Displayed		Other	
		+Shift*		+Shift*		+Shift*
a	ACQ menu	Same as left	a	A		
b	MATH menu	Same as left	b	B		
c	Execute COPY	Same as left	c	C		
d	DISPLAY menu	Same as left	d	D		
e	ENHANCED menu	Same as left	e	E		
f	FILE menu	Same as left	f	F		
g	GO/NOGO menu	Same as left	g	G		
h	HISTORY menu	Same as left	h	H		
i	Execute IMAGE SAVE	Same as left	i	I		
j	PRESET menu	Same as left	j	J		
k			k	K		
l			l	L		
m	MEASURE menu	Same as left	m	M		
n			n	N		
o			o	O		
p	POSITION menu	Same as left	p	P		
q	Execute CLEAR TRACE	Same as left	q	Q		
r	Execute RESET	Same as left	r	R		
s	SHIFT condition	Same as left	s	S		
t	TRIGMODE menu	Same as left	t	T		
u	CURSOR menu	Same as left	u	U		
v			v	V		
w	SIMPLE menu	Same as left	w	W		
x			x	X		
y			y	Y		
z	ZOOM menu	Same as left	z	Z		
1	CH1 menu		1	!		
2	CH2 menu		2	"		
3	CH3 menu		3	#		
4	CH4 menu		4	\$		
5			5	%		
6			6	&		
7			7	'		
8			8	(		
9			9	)		
0			0			
Enter	Return(Enter), Select	Same as left	Return(Enter)	Same as left	Return(Enter)	Same as left
Esc	Escape	Same as left	Escape	Same as left	Escape	Same as left
Back Space			Back Space	Same as left		
Tab						
Space Bar			Space Bar	Same as left		
-			-	=		
^			^	~		
@			@	`		
[			[	{		
;			;	+		
:			:	*		
]			]	}		
,			,	<		
.			.	>		
/	MISC menu	Execute HELP	/	?		
Caps Lock			Caps Lock	Same as left		

## Appendix 5 Key Assignments of the USB Keyboard

F1	Select soft key1	Same as left	Select soft key1	Same as left	Select soft key1	Same as left
F2	Select soft key2	Same as left	Select soft key2	Same as left	Select soft key2	Same as left
F3	Select soft key3	Same as left	Select soft key3	Same as left	Select soft key3	Same as left
F4	Select soft key4	Same as left	Select soft key4	Same as left	Select soft key4	Same as left
F5	Select soft key5	Same as left	Select soft key5	Same as left	Select soft key5	Same as left
F6	Select soft key6	Same as left	Select soft key6	Same as left	Select soft key6	Same as left
F7	Select soft key7	Same as left	Select soft key7	Same as left	Select soft key7	Same as left
F8	Escape	Same as left	Escape	Same as left	Escape	Same as left
F9						
F10						
F11			μ	Same as left		
F12	START/STOP	Same as left	Ω	Same as left	START/STOP	Same as left
Print Screen	Execute COPY	Same as left				
Scroll Lock	Execute IMAGE SAVE	Same as left				
Pause	Execute SNAPSHOT	Same as left				
Insert			Insert condition	Same as left		
Home	Decrement V/Div	Same as left			Decrement V/Div	Same as left
Page Up	Decrement T/Div	Same as left			Decrement T/Div	Same as left
Delete			Delete	Same as left		
End	Increment V/Div	Same as left			Increment V/Div	Same as left
Page Down	Increment T/Div	Same as left			Increment T/Div	Same as left
→	Cursor to the right	Same as left	Cursor to the right	Same as left	Cursor to the right	Same as left
←	Cursor to the left	Same as left	Cursor to the left	Same as left	Cursor to the left	Same as left
↓	Jog shuttle down	Same as left	Select soft key6	Same as left	Jog shuttle down	Same as left
↑	Jog shuttle up	Same as left	Select soft key6	Same as left	Jog shuttle up	Same as left
\	SETUP menu	Same as left	\			
\			\	-		
(Numeric)						
Num Lock						
/			/	Same as left		
*	START/STOP	Same as left	*	Same as left	START/STOP	Same as left
-			-	Same as left		
+			+	Same as left		
Enter			Return(Enter)	Same as left	Return(Enter),Select	Same as left
1	CH1 menu	Increment V/Div	1			Increment V/Div
2	CH2 menu	Jog shuttle down	2			Jog shuttle down
3	CH3 menu	Increment T/Div	3			Increment T/Div
4	CH4 menu	Cursor to the left	4			Cursor to the left
5			5			
6		Cursor to the right	6			Cursor to the right
7		Decrement V/Div	7			Decrement V/Div
8		Jog shuttle up	8			Jog shuttle up
9		Decrement T/Div	9			Decrement T/Div
0			0	Insert condition		
.			.	DELETE		

\* The operation of the key when holding down the Shift key on the USB keyboard.

# Index

## Symbols

1 cycle mode ..... 10-44

## A

A Delay B trigger ..... 2-9  
A delay B trigger ..... 6-17  
A->B(N) trigger ..... 2-8, 6-14  
AC ..... 2-12  
AC1 MΩ ..... 2-4  
accumulated display ..... 2-18  
accumulating waveform ..... 8-5  
accuracy test ..... 16-9  
ACQ ..... 1-6  
ACQ count ..... 6-39  
acquisition mode ..... 2-14, 7-5  
action count ..... 6-39  
action mail ..... 13-13  
action-on-trigger ..... 2-13, 6-38  
adding ..... 9-3  
addition ..... 2-21  
additional information ..... 11-5  
allocation ..... 8-9  
ambient humidity ..... 3-3  
ambient temperature ..... 3-3  
analysis ..... 1-5  
angle cursor ..... 2-27, 10-35, 10-37  
ASCII ..... 12-17  
ASCII header file format ..... App-13  
attenuation ..... 5-8  
auto ..... 9-4  
auto level mode ..... 2-11, 6-1  
auto mode ..... 2-11, 6-1  
auto naming ..... 12-18, 12-24, 12-36  
auto scroll ..... 2-26  
auto scroll search ..... 10-22  
auto setup ..... 2-32, 4-15  
automated measurement mode ..... 10-42, 10-55  
automated measurement of waveform parameter  
..... 2-28, 10-39  
automated measurement values of waveform parameter  
..... 12-30  
auxiliary I/O section ..... 17-8  
averaging mode ..... 2-15, 7-6

## B

backlight ..... 15-9  
bandwidth limit ..... 2-5, 5-14  
binary ..... 12-17  
binary computation ..... 2-21, 9-6  
block diagram ..... 2-1  
box average ..... 2-15, 7-6  
brightness ..... 15-9  
built-in printer ..... 11-1, 11-3, 17-7  
buzzer ..... 6-39

## C

calculate the area of a waveform ..... App-11  
calibration ..... 1-7, 4-18  
carrying the instrument ..... 3-2  
center ..... 9-4  
channel ..... 5-1  
cleaning ..... 3-2  
CLEAR TRACE ..... 1-7  
clear trace ..... 2-19  
clearing trace ..... 8-13  
click sound ..... 15-1  
color mode ..... 12-35  
command ..... 2-30  
comment ..... 11-5, 11-9, 11-12, 12-36, 13-15  
commercial power supply ..... 6-13  
common operation ..... 1-5  
communication ..... 2-30  
compensating ..... 3-11  
compress mode ..... 12-35  
computation ..... 2-21  
computation parameter ..... 10-56  
computation start point ..... 9-13  
computed waveform ..... 9-1  
computer interface ..... 17-9  
control script ..... 13-39  
COPY ..... 1-6  
copying file ..... 12-46  
coupling ..... 5-7  
creating directory ..... 12-50  
current probe ..... 3-9  
current-to-voltage conversion ratio ..... 2-5, 5-8  
CURSOR ..... 1-5  
cursor measurement ..... 2-27, 10-31

## D

data capture ..... 13-29  
date ..... 3-13  
DC ..... 2-12  
DC1 MΩ ..... 2-4  
DC50 Ω ..... 2-4  
default gateway ..... 13-5  
default value ..... App-17  
degree ..... 2-27, 10-37  
delay ..... 6-19  
delay between waveform ..... 10-44  
delay time ..... 4-20  
deleting file ..... 12-42  
des skew ..... 4-21  
determination ..... 6-27  
determination logic ..... 10-62, 10-67  
determination parameter ..... 10-67  
determination status ..... 10-27  
determination zone ..... 10-62  
DHCP ..... 13-5  
differential probe ..... 3-9  
differentiating ..... 9-10  
differentiation ..... 2-21  
dimensional drawing ..... 17-12  
directory name ..... 12-50  
DISPLAY ..... 1-5  
display ..... 17-4

## Index

display color ..... 15-8  
display, computation ..... 1-5  
display format ..... 2-17, 8-1  
display screen ..... 1-8  
distal ..... 10-45  
DNS ..... 13-6  
DNS server ..... 13-6  
domain suffix ..... 13-6

## E

e-mails (SMTP client) ..... 2-31  
edge search ..... 2-24, 10-14  
edge trigger ..... 2-8, 6-8  
emission ..... 17-11  
ENHANCED ..... 1-5  
enhanced trigger ..... 2-8  
entering string ..... 4-4  
entering value ..... 4-3  
envelope mode ..... 2-15, 7-6  
error in system operation ..... 16-6  
error message ..... 16-2  
errors in execution ..... 16-3  
errors in setting ..... 16-5  
ethernet communication ..... 1-7  
external clock input terminal ..... 14-2  
external clock signal ..... 5-17  
external trigger ..... 6-11  
external trigger input terminal ..... 14-1

## F

FET probe ..... 3-9  
FFT ..... 9-12  
FFT function ..... 2-22  
field number ..... 6-35  
FILE ..... 1-6  
file attribute ..... 12-42  
file name ..... 12-50  
Fit Meas Rng to Z1 ..... 8-9  
flattop window ..... 9-13  
float ..... 12-17  
floppy disk ..... 12-3  
floppy disk drive test ..... 16-9  
flow of operation ..... viii  
format ..... 8-2  
formatting ..... 12-8  
frame skip ..... 6-37  
front panel ..... 1-1  
FTP client ..... 2-30, 13-8  
FTP passive ..... 13-50  
FTP passive mode ..... 13-49  
FTP server ..... 2-31, 13-10, 13-18  
FTP server (on a Web browser) ..... 13-28  
function ..... 17-4  
fuse ..... 16-11

## G

general specification ..... 17-10  
GND ..... 2-4  
GO/NO-GO ..... 1-6  
GO/NO-GO determination ..... 2-29, 10-58, 10-64  
GO/NO-GO determination signal output ..... 10-68  
graticule ..... 2-20, 8-14  
Greenwich mean time ..... 13-45  
ground level ..... 5-5  
guide ..... 11-2

## H

handling precaution ..... 3-1  
hanning window ..... 9-13  
hard copy ..... 6-39, 10-63  
HELP ..... 1-7  
help ..... 4-22  
help window ..... 4-22  
HF rejection  
..... 2-12, 6-10, 6-16, 6-19, 6-23, 6-27, 6-30, 6-33  
HISTORY ..... 1-6  
history memory ..... 2-16  
history search ..... 2-23, 10-5, 10-9  
history waveform ..... 2-23, 10-1  
hold off time ..... 6-6  
horizontal axis ..... 1-4, 2-3, 2-6  
horizontal cursor ..... 2-27, 10-31, 10-37  
hysteresis ..... 6-10, 6-16, 6-19, 6-23, 6-27, 6-30

## I

IMAGE SAVE ..... 1-6  
image save ..... 6-39, 10-63  
immunity ..... 17-11  
initialization ..... 2-32  
initializing ..... 4-13  
input coupling ..... 2-4, 5-6  
input section ..... 17-1  
installation condition ..... 3-3  
installation position ..... 3-4  
instrument information ..... 13-43  
instrument number ..... ii  
integrating ..... 9-10  
integration ..... 2-21  
intensity ..... 15-6  
interleave mode ..... 2-14, 7-3  
interpolation ..... 2-17, 8-3  
inversion ..... 2-21  
inverting ..... 9-8  
IP address ..... 13-5

## J

jog shuttle ..... 4-1  
jumping the cursor ..... 10-38

## K

key ..... 4-1  
key assignments of the USB keyboard ..... App-18  
key test ..... 16-9  
knob ..... 1-4

## L

line number ..... 6-36  
linear interpolation ..... 2-17  
linear scaling ..... 2-5, 5-15  
link ..... 13-44  
log ..... 13-41  
login name ..... 13-10  
LPR client ..... 13-11  
LPR name ..... 13-12  
LPR server ..... 13-12  
LPR time out ..... 13-49, 13-50



**M**

MAC address .....	13-47
magnification .....	11-5
mail address .....	13-15
mail server .....	13-15
main power switch .....	3-6
malfunction? .....	16-1
manual .....	9-4
mapping .....	2-17, 8-2
marker cursor .....	2-27, 10-33, 10-37
MATH .....	1-6
MEASURE .....	1-5
measurement per cycle .....	10-47
measurement trend .....	13-35
memory test .....	16-9
menu language .....	15-1
mesial .....	10-45
message language .....	15-1
MISC .....	1-7
MODE .....	1-5
model .....	ii
moving average point .....	7-7
multiplication .....	2-21
multiplying .....	9-3

**N**

network .....	13-1
network drive .....	2-30
network printer .....	11-10
network printer (LPR client) .....	2-30
NO .....	ii
normal mode .....	2-11, 2-14, 6-1, 7-6
normal statistical processing .....	2-28, 10-46
NTP server .....	3-14
number of computed point .....	9-13

**O**

offset voltage .....	2-5, 5-9, 15-5
operator .....	9-4, 9-7, 9-9, 9-11, 9-13, 9-15
option specification .....	ii
OR trigger .....	2-10, 6-28
other operation .....	1-7
output resolution .....	11-9, 11-12
overview .....	16-10

**P**

page description language .....	11-9, 11-12
panel key .....	1-4
parallel pattern search .....	2-25, 10-18
password .....	13-10, 13-19
pattern trigger .....	2-9, 6-20
PC card .....	12-4
PC Card Test .....	16-9
performing automated measurements of waveform parameter .....	10-53
periodic mail .....	13-13
phase correction .....	3-11
phase shift .....	2-21
polarity .....	6-35
POSITION .....	1-5
power .....	3-5
power cord .....	ii, 3-5
power fuse .....	16-11
power spectrum .....	9-12

power spectrum display .....	2-22
power switch .....	3-6
prefix unit .....	4-7
PRESET .....	1-4
preset .....	2-32, 5-11
print format .....	11-5
printer name .....	13-12
printer test .....	16-9
printing screen image .....	1-6
probe .....	3-8
probe attenuation .....	2-5, 5-8
properties .....	12-19, 12-24, 12-49
proximal .....	10-45
pulse interpolation .....	2-17
pulse width search .....	2-26, 10-20

**R**

realtime sampling mode .....	2-7
rear panel .....	1-2
recalling .....	4-5, 12-1
recommended replacement part .....	16-12
record length .....	2-14, 7-2, App-1
rectangular .....	9-13
reference point .....	10-44
release arm .....	11-2
repetitive sampling mode .....	2-7, 7-4
roll mode .....	5-19
roll mode display .....	2-7
roll paper .....	11-1
roller .....	11-2
rubber feet .....	3-4

**S**

safety standard .....	17-11
sample rate .....	App-1
sampling mode .....	2-7, 2-14, 5-19
save to file .....	6-39, 10-63
saving and loading data .....	1-6
scale .....	8-14, 8-15
scale value .....	2-20
scaling .....	9-4, 9-7, 9-9, 9-11, 9-13, 9-15
scaling the computed waveform .....	2-21
screen color .....	15-6
screen image .....	2-33
screen image data .....	12-33
search .....	1-5
search and zoom .....	2-24, 10-14
search logic .....	10-8, 10-12
search parameter .....	10-12
search zone .....	10-7
select zone .....	10-7
self-test .....	16-7
send mail .....	6-39, 10-63
sensitivity .....	9-4
sequential store .....	2-16, 7-8
serial pattern search .....	2-24, 10-16
setting .....	12-20
SETUP .....	1-5
setup dialog box .....	4-2
setup information list .....	1-10
setup menu .....	4-1
shifting the phase .....	9-16
signal input terminal .....	3-8
SIMPLE .....	1-5
simple trigger .....	2-8
sine interpolation .....	2-17

## Index

single mode ..... 2-11, 6-2  
single(N) count ..... 7-9  
SINGLE(N) mode ..... 7-8  
single(N) mode ..... 2-11, 6-2  
skew ..... 4-21  
slope ..... 10-44  
smoothing ..... 9-5, 9-7, 9-9, 9-11, 9-14, 9-15  
SMTP client ..... 13-13  
SMTP time out ..... 13-49, 13-50  
SNAP SHOT ..... 1-7  
snapshot ..... 2-19, 8-13  
snapshot waveform ..... 12-26  
SNTP server ..... 3-14  
soft key test ..... 16-9  
splitting the screen ..... 2-17  
START/STOP ..... 1-6  
starting waveform acquisition ..... 7-1  
statistical processing ..... 2-28, 10-46  
statistical processing by cycle ..... 2-28  
statistical processing of history waveform ..... 2-28, 10-50  
statistical processing within the measurement range ..... 10-47  
status message ..... 16-2  
stopping waveform acquisition ..... 7-1  
storage ..... 17-7  
storage medium ..... 2-33  
storing ..... 12-1  
subnet mask ..... 13-5  
subtracting ..... 9-3  
subtraction ..... 2-21  
suffix ..... ii  
symbol ..... v  
system condition ..... 16-10  
system configuration ..... 2-1

## T

T/div ..... 5-19  
TCP/IP ..... 13-3  
temporary storage of character string ..... 4-4  
test mail ..... 13-15  
threshold level for binary computation ..... 9-7  
thumbnail ..... 12-36, 12-37  
time ..... 3-13  
time axis ..... 2-6, 17-3  
time axis setting ..... App-1  
time base ..... 2-6, 5-17  
time difference from GMT ..... 13-45  
time out ..... 13-10, 13-19  
time window ..... 9-13  
TIME/DIV knob ..... 1-4  
top panel ..... 1-3  
trace label ..... 8-17  
translucent display ..... 2-20, 8-18  
transmission interval ..... 13-15  
transmission time ..... 13-15  
TRIG'D indicator ..... 1-5  
trigger ..... 1-5  
trigger coupling ..... 2-12, 6-10, 6-16, 6-19, 6-23, 6-27, 6-30, 6-33  
trigger delay ..... 2-12, 6-5  
trigger gate ..... 2-12, 6-40  
trigger gate input terminal ..... 14-3  
trigger hold off ..... 2-13  
trigger hysteresis ..... 2-13  
trigger level ..... 2-8, 6-9, 6-12, 6-16, 6-19, 6-23, 6-27, 6-30, 6-35  
trigger mode ..... 2-11, 6-1  
trigger output terminal ..... 14-4

trigger position ..... 2-12, 6-3  
trigger section ..... 17-2  
trigger slope ..... 2-8, 6-9, 6-12  
trigger source ..... 2-8, 6-9, 6-12, 6-13  
trigger type ..... 2-8  
TV trigger ..... 2-11, 6-34

## U

unload ..... 12-19  
USB keyboard ..... 2-32, 4-6  
USB keyboard language ..... 15-3  
USB mouse ..... 2-32, 4-8  
USB PERIPHERAL connector ..... 4-6, 4-8, 11-8  
USB peripheral interface ..... 17-7  
USB printer ..... 11-6  
USB storage ..... 12-6  
user name ..... 13-19

## V

V/div ..... 5-2  
V/DIV knob ..... 1-4  
variable ..... 5-3  
vertical axis ..... 1-4, 2-3  
vertical cursor ..... 2-27, 10-32, 10-37  
vertical position ..... 2-3, 5-4  
vertical sensitivity ..... 2-3  
VIDEO OUT (VGA) ..... 14-6  
video output terminal ..... 14-6

## W

waveform acquisition ..... 1-5  
waveform data ..... 12-12  
waveform label ..... 2-20, 8-16  
waveform parameter search ..... 2-23  
Web server ..... 2-31, 13-20  
WebDAV ..... 13-52  
width trigger ..... 2-10, 6-24  
window trigger ..... 2-10, 6-31

## X

X-axis mode ..... 8-12  
X-Y waveform ..... 8-10  
X-Y waveform display ..... 2-19

## Z

zone search ..... 2-23  
ZOOM ..... 1-4  
zoom position ..... 8-9  
zoom rate ..... 8-9  
zooming the waveform ..... 2-18, 8-7